

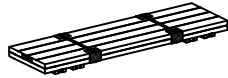





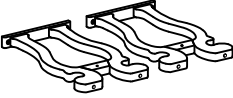

# Assembly Instructions

ITEM NO: 22523/22524/30431

Thank you for purchasing this quality product. Be sure to check all packing material carefully for small parts that may have come loose inside the carton during shipment. (Note: Loosely thread all screws/bolts first. Once the item is assembled then completely tighten.)

PARTS LIST:				HARDWARE LIST:				
No.	Description	Sketch	Quality	No.	Sketch	Description	Size	Quality
1	Table Top		1 Pc	A		Allen Head Bolt	Ø8x40mm	6 Pcs
				B		Allen Head Bolt	Ø8x80mm	2 Pcs
2	Leg Frames		2 Pcs	C		Lock Washer	Ø9xØ13mm	8 Pcs
				D		Flat Washer	Ø8xØ20mm	8 Pcs
3	Support Legs		2 Pcs	E		Allen Key	4x110mm	1 Pc
				F		Cover cap	Ø23x15mm	2 Pcs

## STEP 1

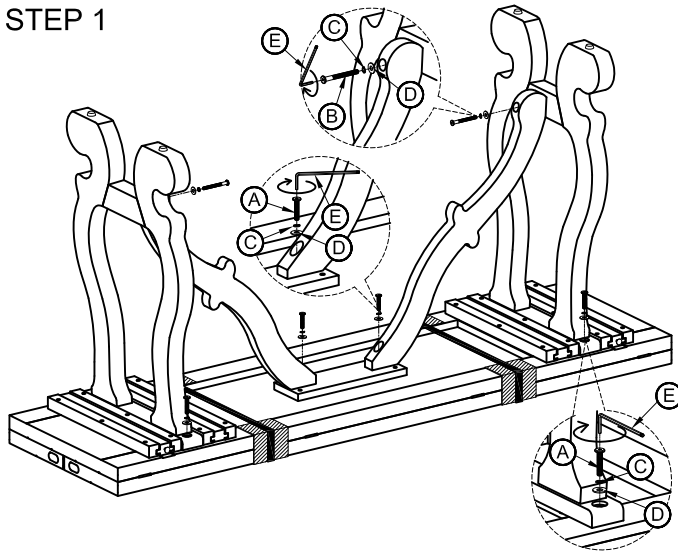

## STEP 2

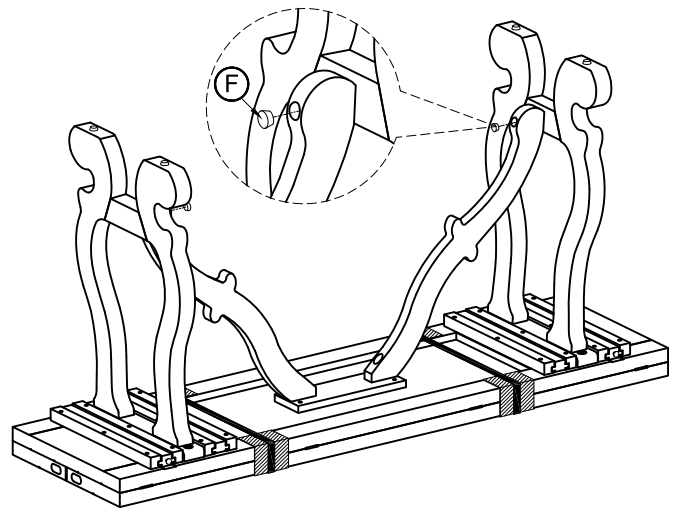

Do not fully tighten the bolts until the complete table has been assembled. Once the complete table is assembled, use the provided Allen Key to fully tighten all the bolts.

## STEP 3

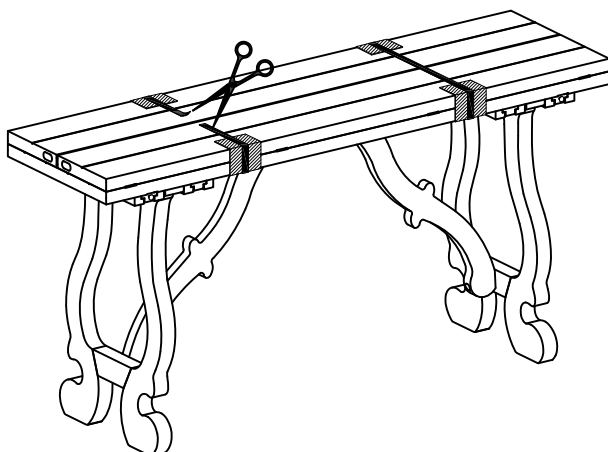

## STEP 4

