







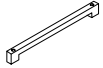
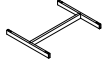
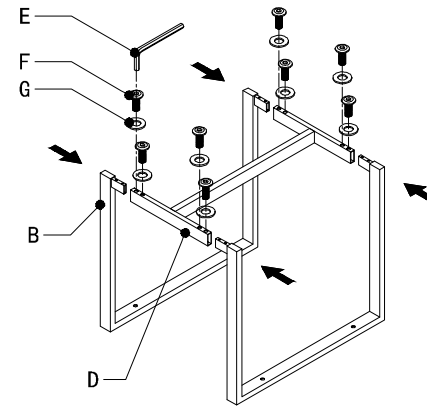

PART LIST:

NO.	DESCRIPTION	PART PHOTO	QTY	NO.	DESCRIPTION	PART PHOTO	QTY
A	TOP		1PC				
B	SIDE FRAME		2PCS				
C	CONNECTING 1		2PCS				
D	CONNECTING 2		1PC				

STEP 1



HARDWARE LIST:

NO.	DESCRIPTION	PART PHOTO	QTY	NO.	DESCRIPTION	PART PHOTO	QTY
E	φ4		1PC				
F	M6*16		8PCS				
G	φ (13-6) *1.0		8PCS				
H	M6*75		4PCS				
I	φ (16-8) *2.0		4PCS				

STEP 2

