

ASSEMBLY INSTRUCTIONS
COASTER FINE FURNITURE



Fine Furniture for every stage of life

902932
SNACK TABLE

REVISION 0 : 09/25/2017
REVISION 1 : 08/14/2020

ITEM:902932



ASSEMBLY INSTRUCTIONS

ASSEMBLY TIPS:

1. Remove hardware from box and sort by size.
2. Please check to see that all hardware and parts are present prior to start of assembly.
3. Please follow attached instructions in the same sequence as numbered to assure fast & easy assembly.





WARNING!

1. Don't attempt to repair or modify parts that are broken or defective. Please contact the store immediately.
2. This product is for home use only and not intended for commercial establishments.

ASSEMBLY TIME 25 MINUTES

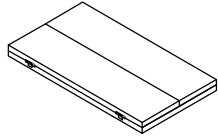
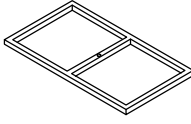
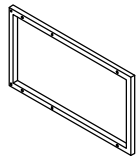
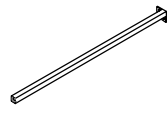



PARTS IDENTIFICATION

A	TOP PANEL		1PC
B	TOP FRAME		1PC
C	BOTTOM FRAME		1PC
D	BACK CROSSBAR		2PCS
E	FRONT CROSSBAR		2PCS

ITEM:902932 ASSEMBLY INSTRUCTIONS



HARDWARE IDENTIFICATION

1	BOLT (1/4" x 1-1/4" BLK)		4PCS
2	CROSS BOLT (3/16" x 12mm BLK)		6PCS
3	LARGE BOLT (ϕ 16 x 29mm)		1PC
4	FLOOR PROTECTOR (ϕ 6.3mm)		4PCS
5	ALLEN WRENCH (4mm)		1PC

ITEM:902932 ASSEMBLY INSTRUCTIONS



STEP 1 Do not tighten until each step is completed or instructed.

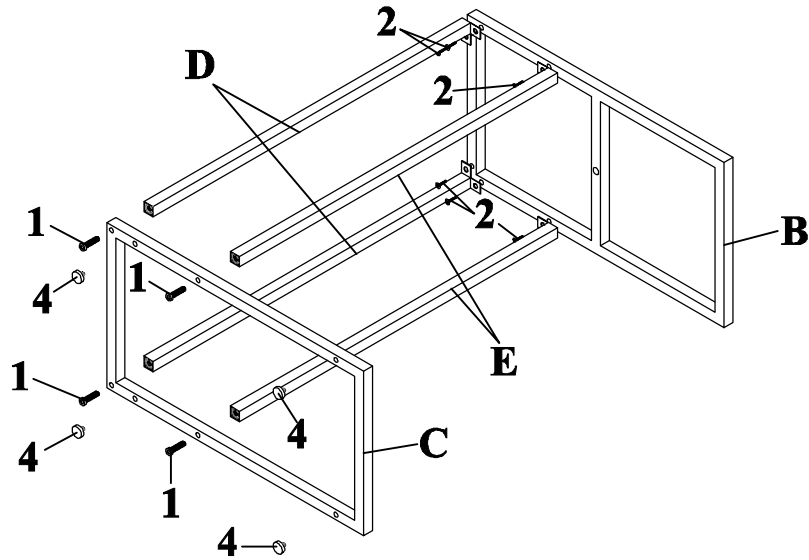

STEP 2

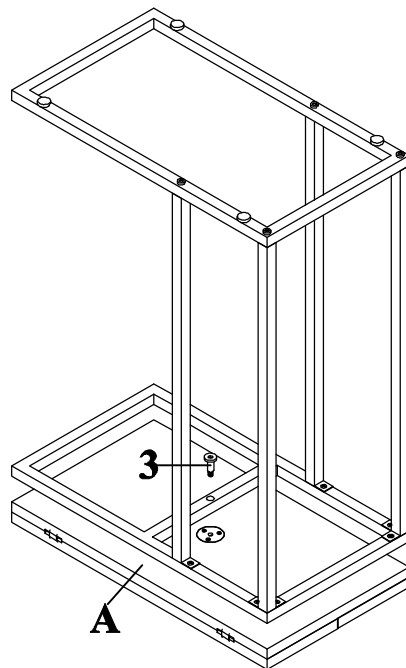

COMPLETE

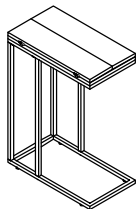

ITEM:902932 ASSEMBLY INSTRUCTIONS



Product Size : 305 X 457 X 641 H (MM)
Product Size : 12" X 18" X 25 1/4"

Product Size : 610 X 457 X 641 H (MM)
Product Size : 24" X 18" X 25 1/4"

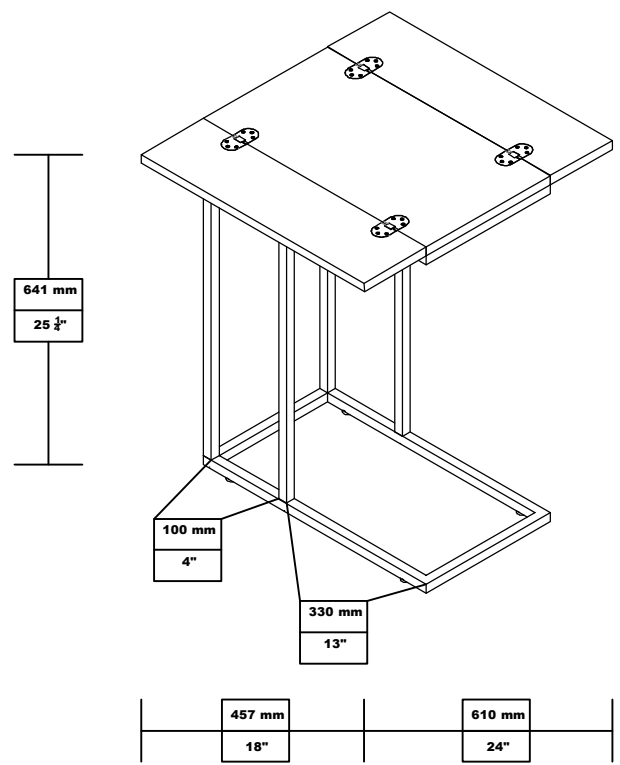
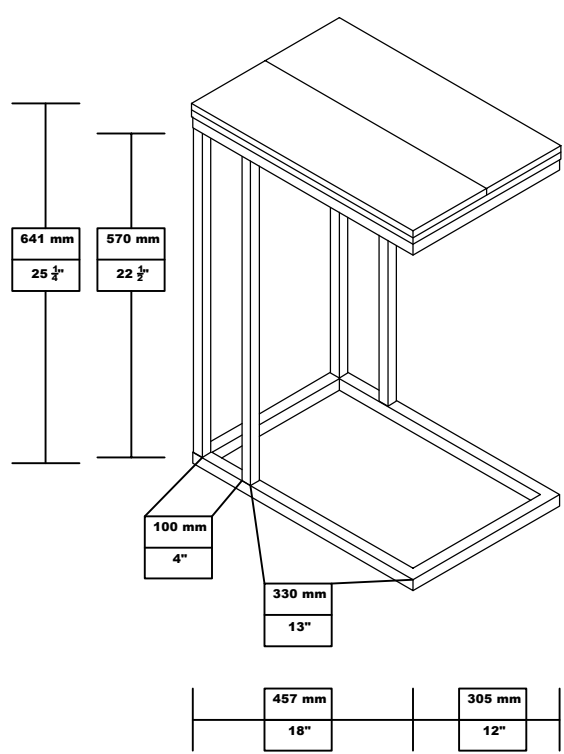

Note : Dimension tolerance $\pm 5\%$