

ASSEMBLY INSTRUCTIONS
COASTER FINE FURNITURE



Fine Furniture for every stage of life

120451
BAR TABLE

REVISION 0 : 08/25/2017
REVISION 1 : 09/08/2020

ITEM:120451



ASSEMBLY INSTRUCTIONS

ASSEMBLY TIPS:

1. Remove hardware from box and sort by size.
2. Please check to see that all hardware and parts are present prior to start of assembly.
3. Please follow attached instructions in the same sequence as numbered to assure fast & easy assembly.



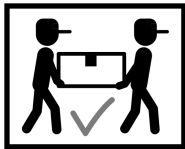

WARNING!

1. Don't attempt to repair or modify parts that are broken or defective. Please contact the store immediately.
2. This product is for home use only and not intended for commercial establishments.





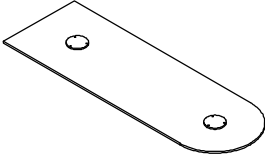

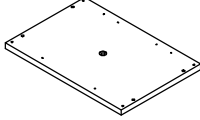
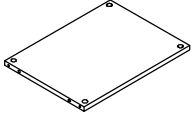
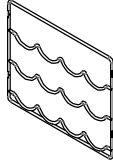
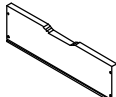
ASSEMBLY TIME 55 MINUTES

PARTS IDENTIFICATION

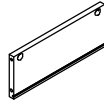
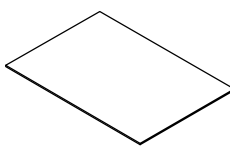
A	TOP GLASS		1PC
B	SIDE BOARD		2PCS
C	TOP BOARD		1PC
D	BASE AND MIDDLE SHELF		3PCS
E	BOTTLE RACK		2PCS
F	DRAWER FRONT PANEL		2PCS

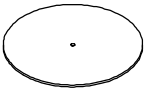
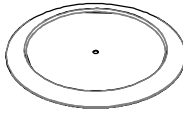
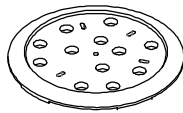
ITEM:120451 ASSEMBLY INSTRUCTIONS

G	DRAWER SIDE PANEL		2PCS
H	DRAWER BOTTOM PANEL		1PC
I	TOP GLASS SUPPORT BAR		1PC
J	CENTER SUPPORT WOOD		1PC
K	CENTER SUPPORT METAL		1PC
L	CENTER SWIVEL PART		1PC
M	TOP GLASS SUPPORT LEG		1PC

ITEM:120451

ASSEMBLY INSTRUCTIONS

N GLASS HOLDER

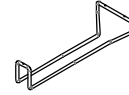

2PCS

HARDWARE IDENTIFICATION

1	CAM-BOLT (38mm)		20PCS	9	LARGE ALLEN KEY (5mm)		1PC
2	LARGE CAM-LOCK (ϕ 15mm)		16PCS	10	SCREW (7# x 5/8")		14PCS
3	LARGE ALLEN BOLT (5/16" x 2-1/2" SR)		2PCS	11	FLOOR PROTECTOR (ϕ 30mm)		4PCS
4	PLASTIC WASHER (5/16" x 50mm)		1PC	12	GLUE		1PC
5	SMALL CAM-BACK (ϕ 15 x 9.5mm)		4PCS	13	SMALL ALLEN BOLT (1/4" x 12mm SR)		6PCS
6	SMALL WASHER (5/16" SR)		2PCS	14	LARGE WASHER (5/16" x 50mm)		2PCS
7	SPRING WASHER (5/16" SR)		2PCS	15	LABEL		4PCS
8	WOOD DOWEL (8 x 30mm)		20PCS	16	SMALL ALLEN KEY (4mm)		1PC

ITEM:120451 ASSEMBLY INSTRUCTIONS



STEP 1

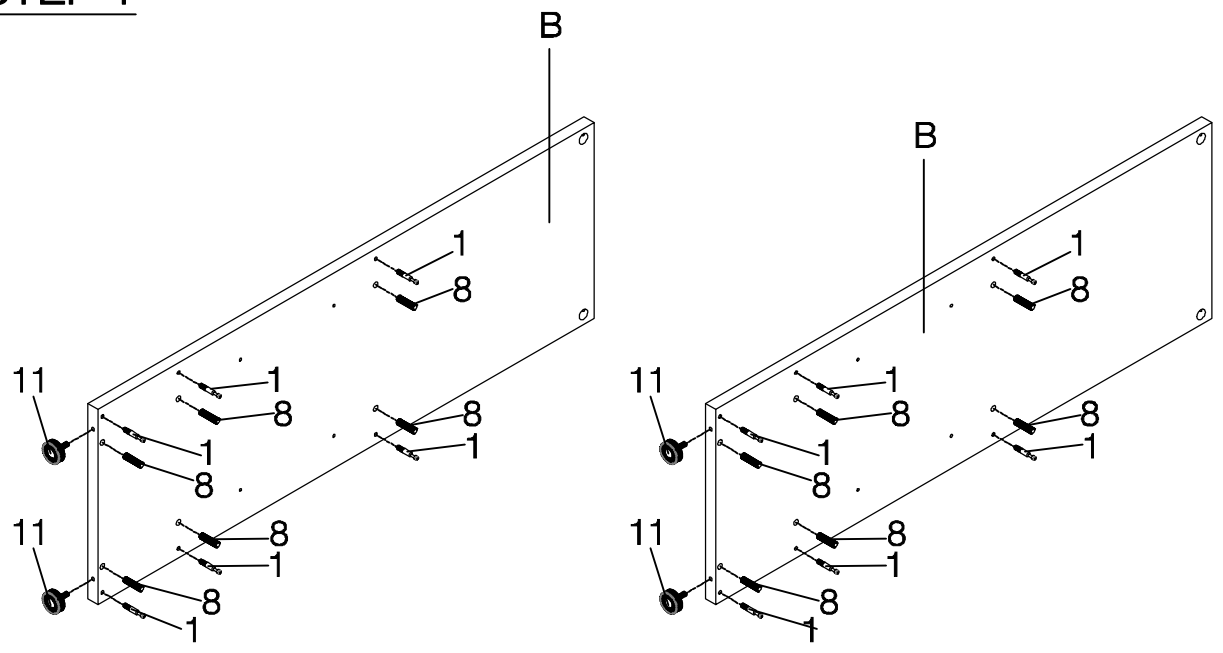

STEP 2

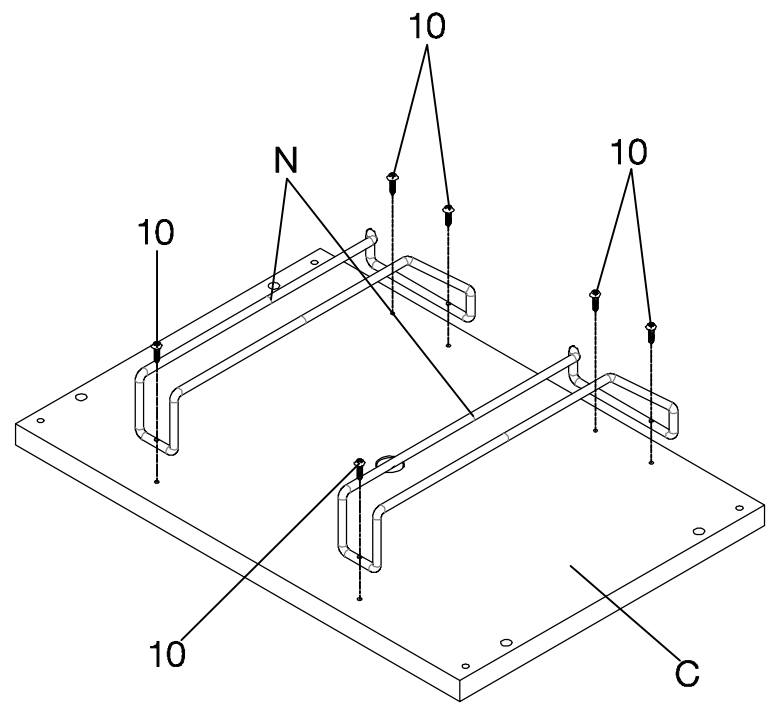

ITEM:120451
ASSEMBLY INSTRUCTIONS
STEP 3

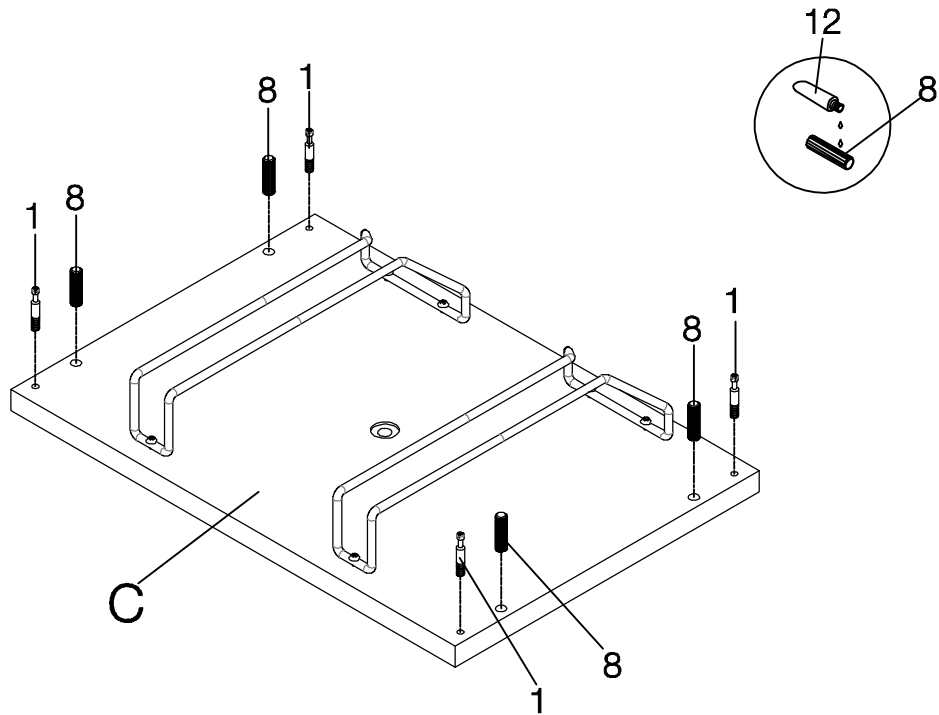

STEP 4

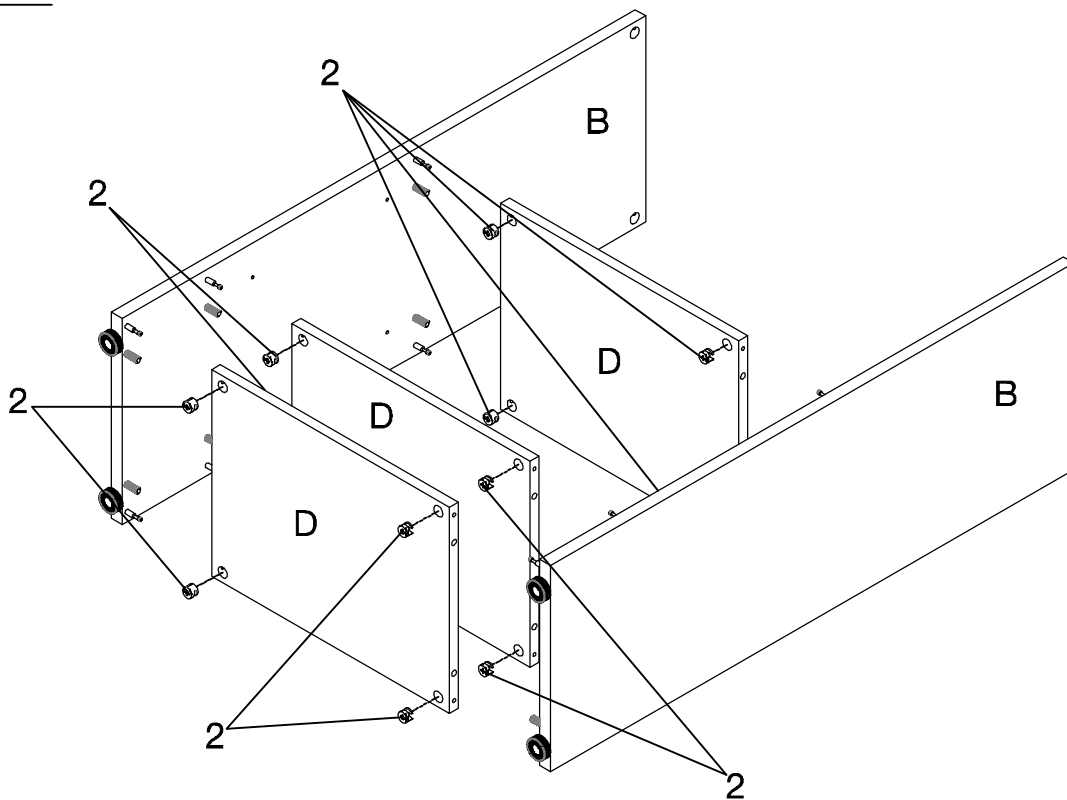

ITEM:120451
ASSEMBLY INSTRUCTIONS
STEP 5

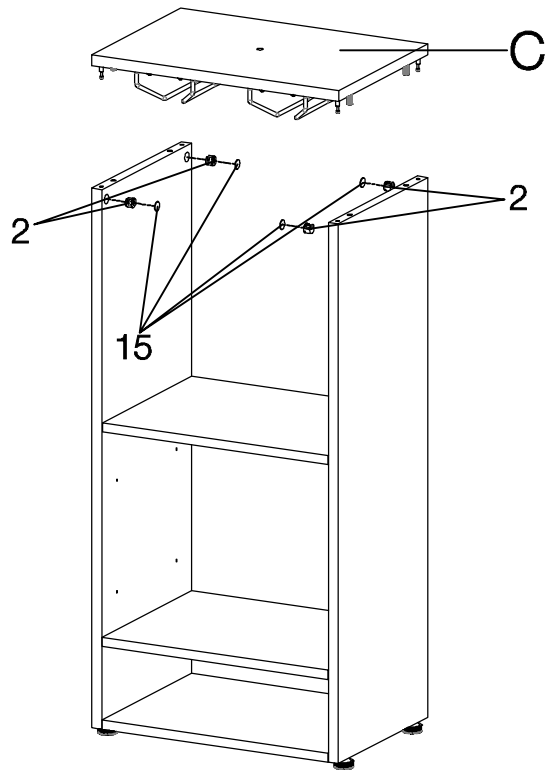

STEP 6

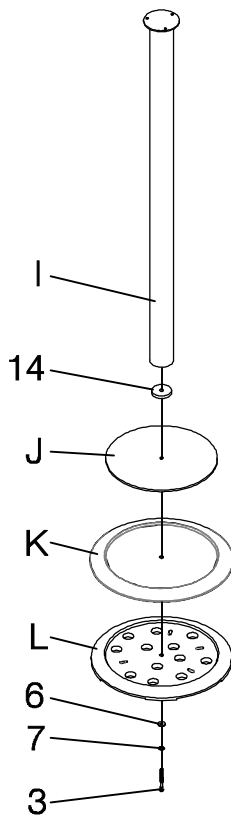

ITEM:120451
ASSEMBLY INSTRUCTIONS
STEP 7

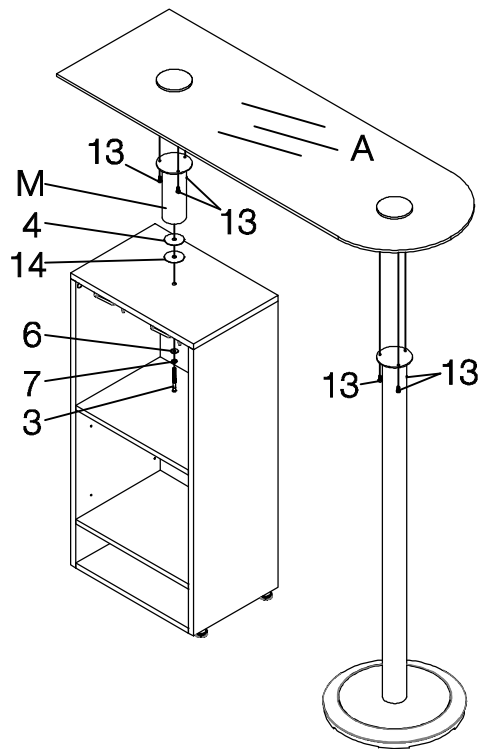

STEP 8

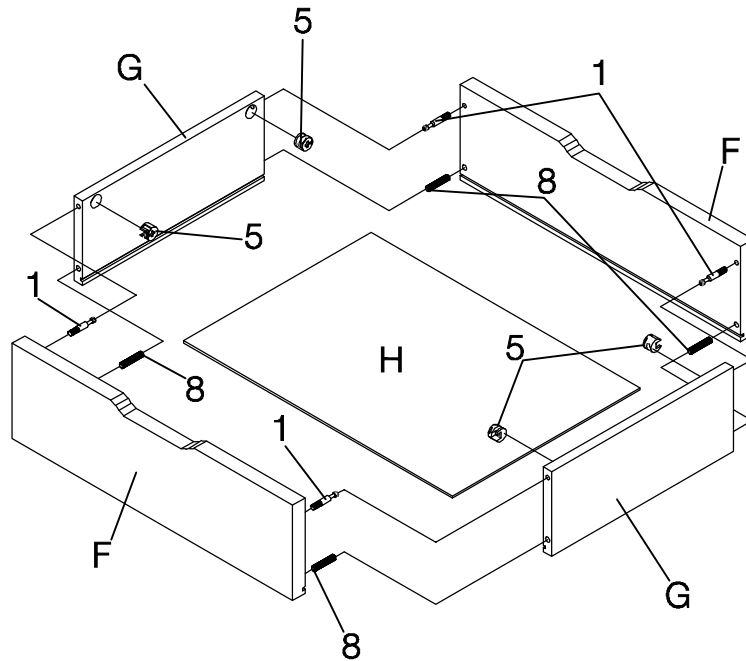

ITEM:120451
ASSEMBLY INSTRUCTIONS
STEP 9

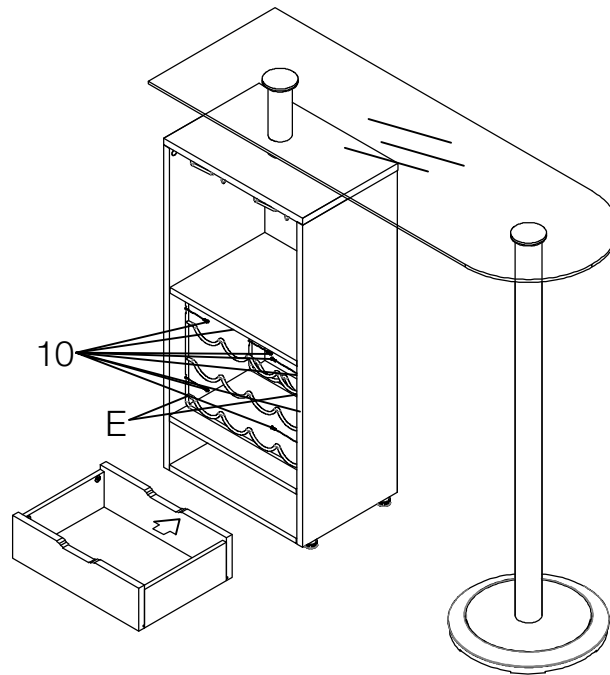

STEP 10
COMPLETE

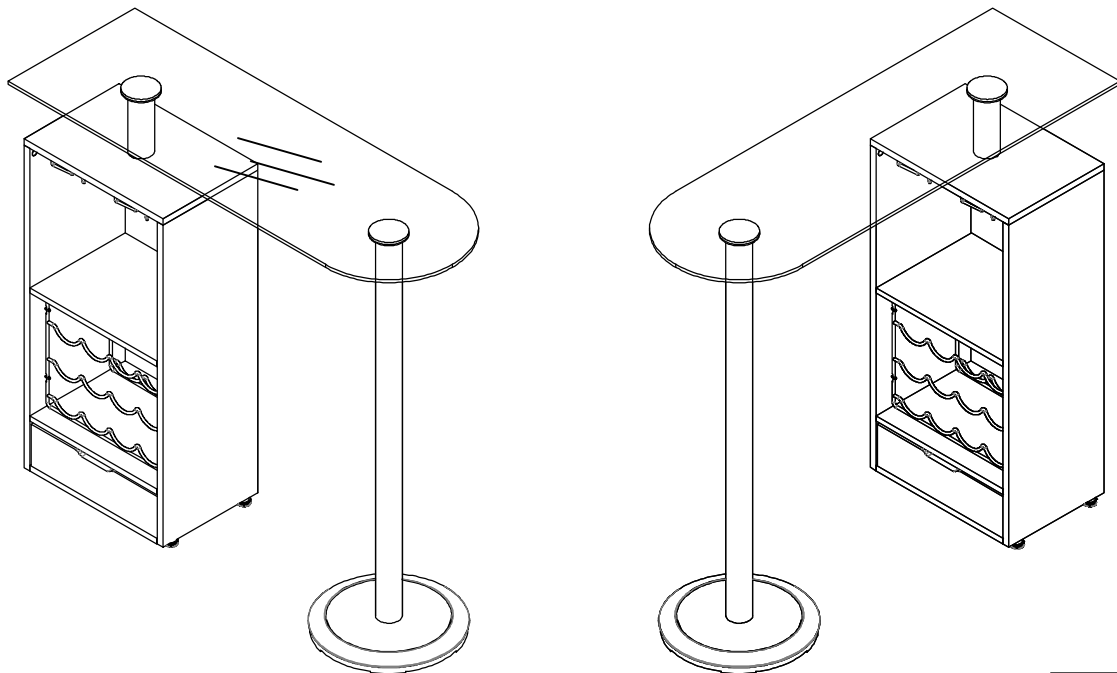

this can be placed either way to suit the individual's needs

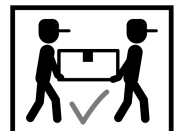

ITEM:120451 ASSEMBLY INSTRUCTIONS



Product Size : 1207 X 406 X 1100 H (MM)
Product Size : 47 1/2" X 16" X 43 1/2"

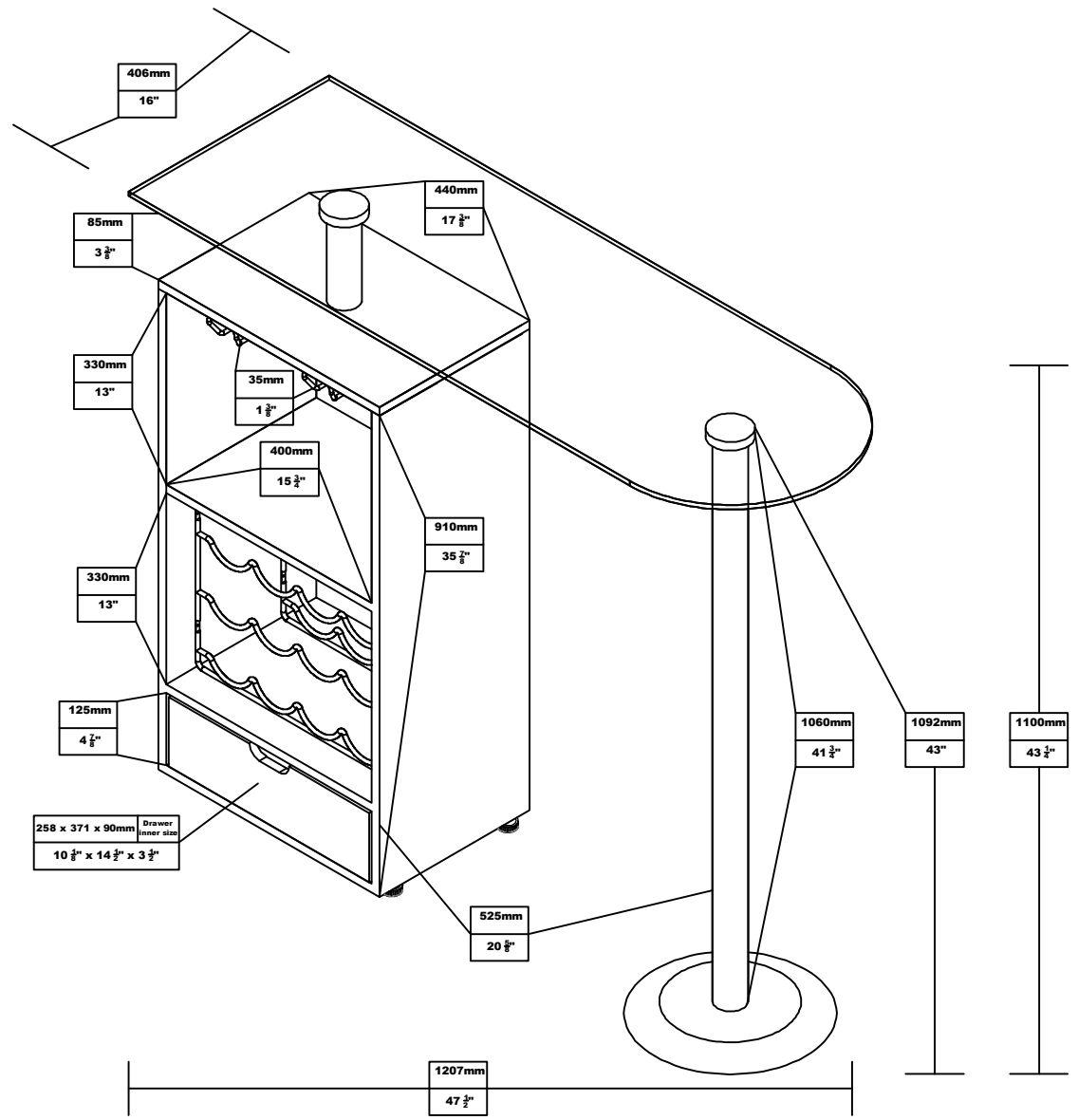

Note : Dimension tolerance $\pm 5\%$