

*ASSEMBLY INSTRUCTIONS*  
*COASTER FINE FURNITURE*



*Fine Furniture for every stage of life*

**108291**  
**DINING TABLE**

REVISION 0 : 12/03/2018  
REVISION 1 : 05/13/2019  
REVISION 2 : 07/01/2020

ITEM:108291



# ASSEMBLY INSTRUCTIONS

## ASSEMBLY TIPS:

1. Remove hardware from box and sort by size.
2. Please check to see that all hardware and parts are present prior to start of assembly.
3. Please follow attached instructions in the same sequence as numbered to assure fast & easy assembly.



### WARNING!



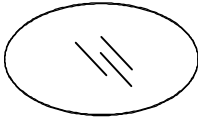
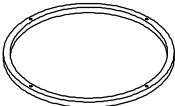
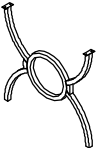
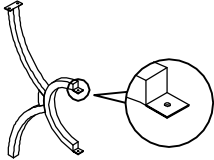
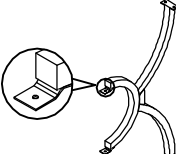

1. Don't attempt to repair or modify parts that are broken or defective. Please contact the store immediately.
2. This product is for home use only and not intended for commercial establishments.

ASSEMBLY TIME 30 MINUTES

## PARTS IDENTIFICATION

A	GLASS		1PC
	*GLASS SOLD SEPARATELY.*		
B	TOP FRAME		1PC
C	LARGE FRAME		1PC
D	LEFT FRAME		1PC
E	RIGHT FRAME		1PC

## HARDWARE IDENTIFICATION

1	SHORT BOLT (1/4" x 15mm BLK)		10PCS	4	LEVELER (5/16" x 15mm BLK)		4PCS
2	SUCTION CUP (20 x 5mm)		4PCS	5	ALLEN WRENCH (4mm)		1PC
3	CAP (30 x 30mm BLK)		4PCS				

# ITEM: 108291 ASSEMBLY INSTRUCTIONS



**STEP 1** Do not tighten until each step is completed or instructed.

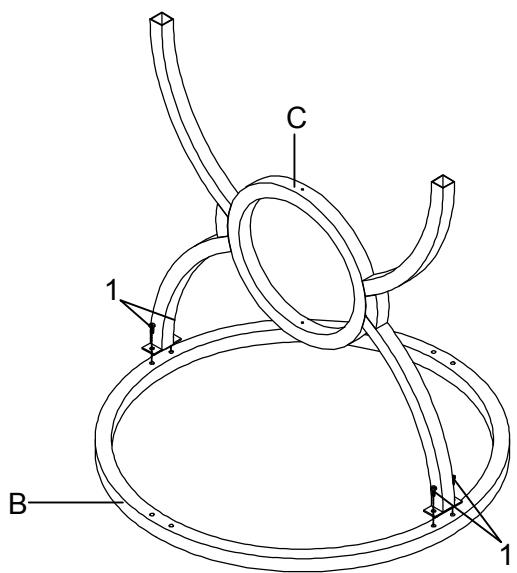

## STEP 2

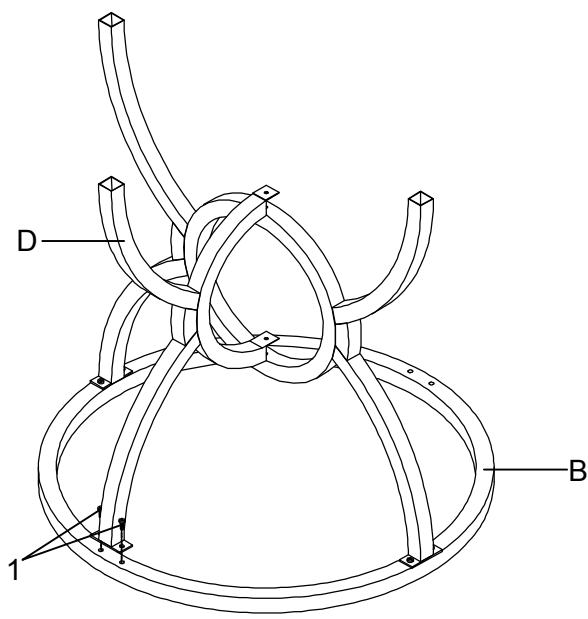

ITEM: 108291  
ASSEMBLY INSTRUCTIONS  
STEP 3

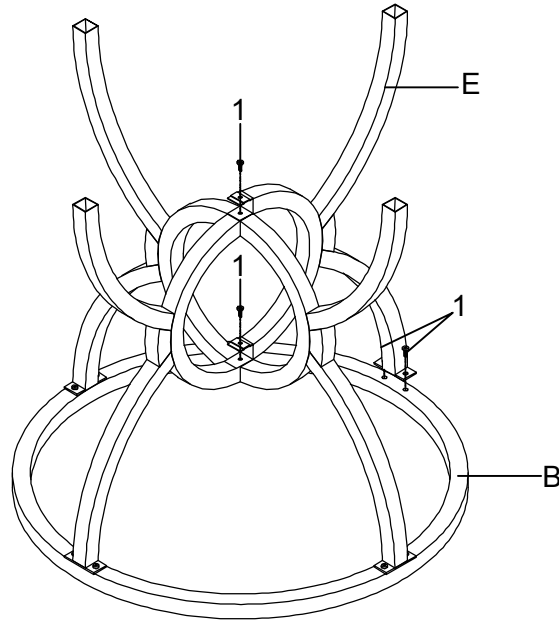

STEP 4

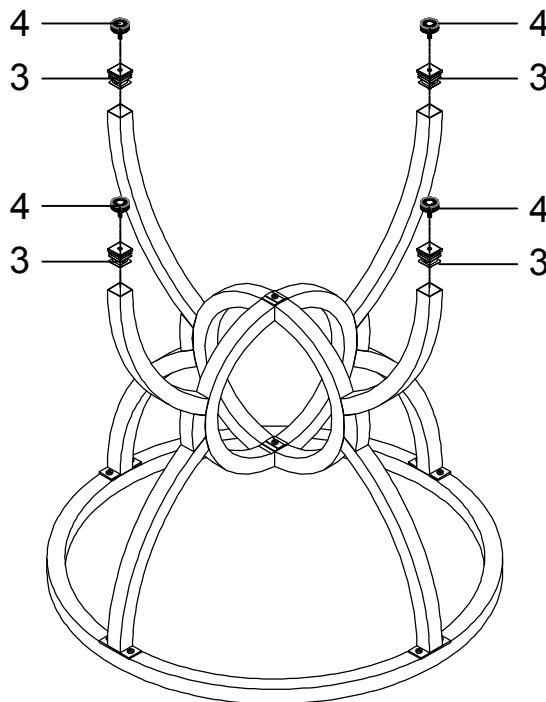

ITEM: 108291  
**ASSEMBLY INSTRUCTIONS**



**STEP 5** \*GLASS (PART#A) SOLD SEPARATELY.\*

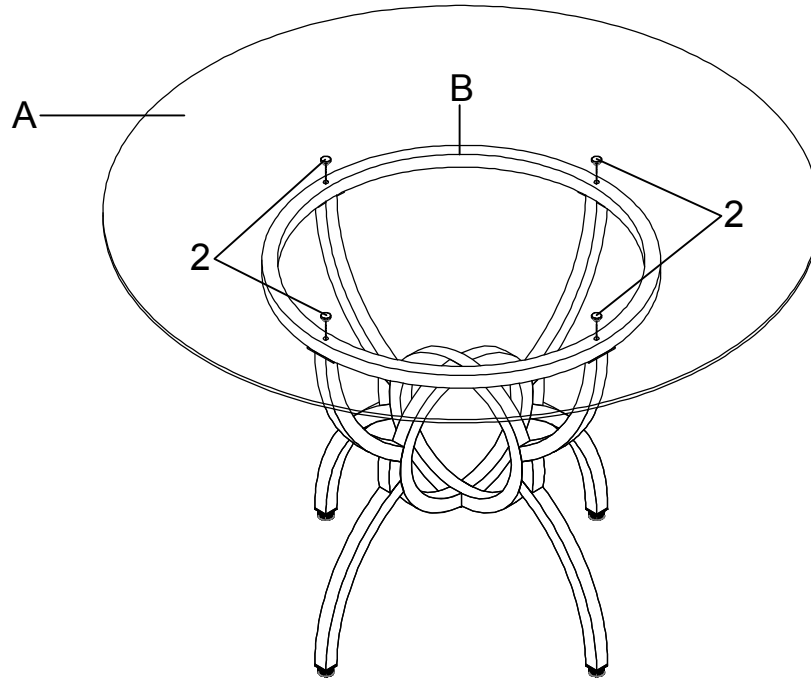

**STEP 6** \*GLASS (PART#A) SOLD SEPARATELY.\*  
**COMPLETE**

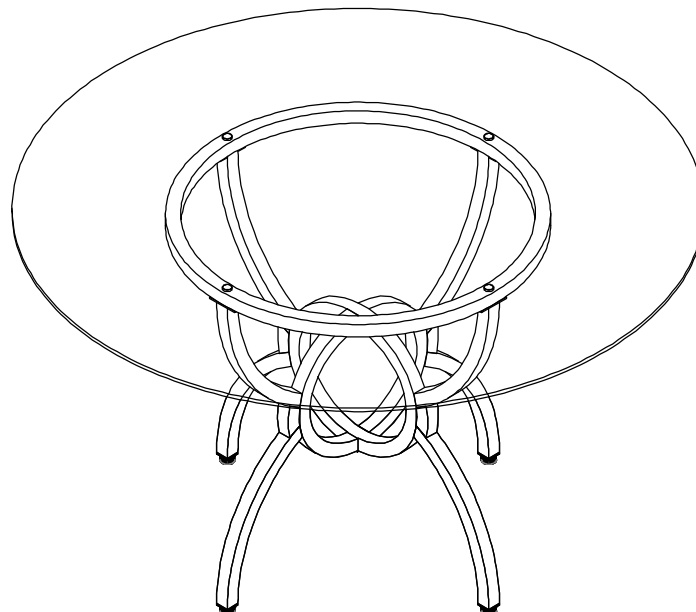

# ITEM:108291 ASSEMBLY INSTRUCTIONS



<b>Product Size : 762 DIA X 762 H (MM)</b>
<b>Product Size : 30" DIA X 30"</b>

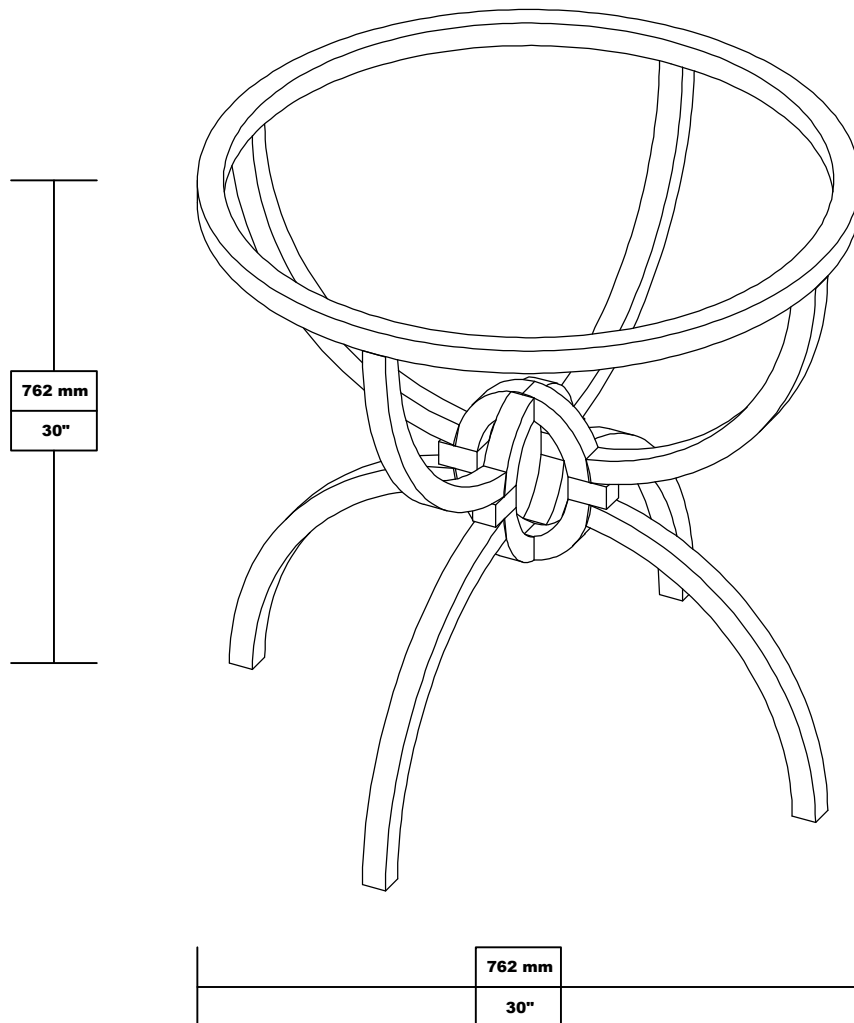

Note : Dimension tolerance  $\pm 5\%$