



ASSEMBLY INSTRUCTIONS COASTER FINE FURNITURE



Fine Furniture for every stage of life

120397
BARSTOOL

REVISION: 06/16/2020

PAGE 1 OF 4

COASTERFURNITURE.COM

ITEM :120397

ASSEMBLY INSTRUCTIONS



ASSEMBLY TIPS:

1. Remove hardware from box and sort by size.
2. Please check to see that all hardware and parts are present prior to start of assembly.
3. Please follow attached instructions in the same sequence as numbered to assure fast & easy assembly.



Warning!



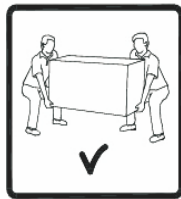

1. Don't attempt to repair or modify parts that are broken or defective. Please contact the store immediately.
2. This product is for home use only and not intended for commercial establishments.





ASSEMBLY TIME

5 MINUTES

PARTS IDENTIFICATION

	PART NAME	FIGURE	QTY
A	SEAT		1 PC
B	FOOT REST		1 PC
C	BASE		1 PC
D	GAS CYLINDER		1 PC
E	COVER RING		1 PC

HARDWARE IDENTIFICATION

	HARDWARE NAME	FIGURE	QTY
1	BOLTS M6x16MM		4PCS
2	ALLEN WRENCH M6		1 PC

ITEM :120397
ASSEMBLY INSTRUCTIONS

STEP1

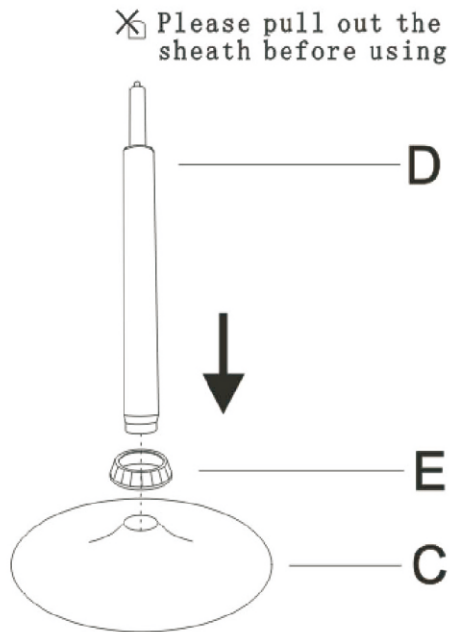

STEP3

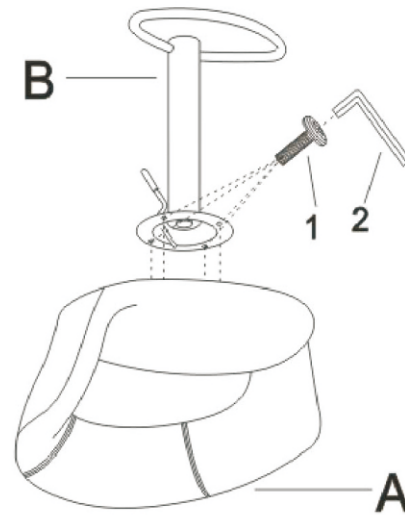

STEP2

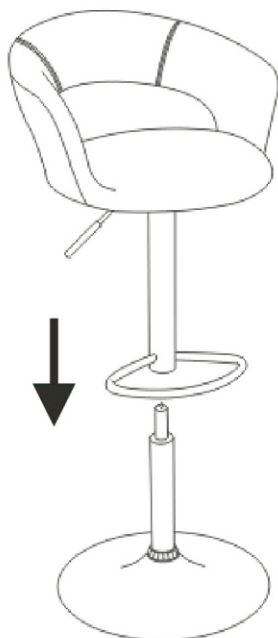

STEP4

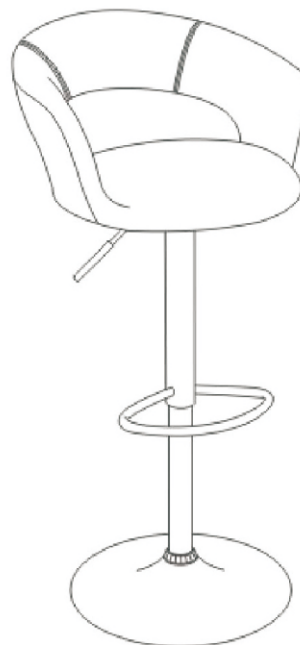

ITEM :120397
ASSEMBLY INSTRUCTIONS



Note:Dimension tolerance±5%