

ASSEMBLY INSTRUCTIONS
COASTER FINE FURNITURE



Fine Furniture for every stage of life

902779

JEWELRY CHEVAL MIRROR

ITEM : 902779



ASSEMBLY INSTRUCTIONS

ASSEMBLY TIPS:

- 1.Remove hardware from box and sort by size.
- 2.Please check to see that all hardware and parts are present prior to start of assembly.
- 3.Please follow attached instruction in the same sequence as numbered to assure fast & easy assembly.



WARNING!

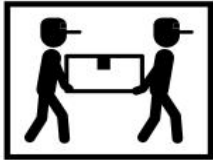

- 1.Don't attempt to repair or modify parts that are broken or defective. Please contact the store
- 2.This product is for home use only and not intended for commercial establishment.







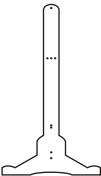

ASSEMBLY TIME

15 MINUTES

PARTS IDENTIFICATION:.

| | | | |
|---|---|-----------------|------|
| A |  | Mirror cabinet | 1PCS |
| B |  | Leg | 2PCS |
| C |  | Top crossbar | 1PCS |
| D |  | Bottom crossbar | 1PCS |

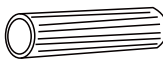
Z HARDWARE IDENTIFICATION

| | | | |
|---|--|---|------|
| 1 |  | Long screws Ø0.5x4.5mm | 6PCS |
| 2 |  | Bolts Ø1x1.1mm | 6PCS |
| 3 |  | Main connecting screws Ø0.5x6.5mm | 2PCS |
| 4 |  | Plastic washer Ø3mm | 2PCS |
| 5 |  | Wooden dowel Ø0.8x3mm | 4PCS |
| 6 |  | Allen key M6x6.7 | 1PCS |

ITEM : 902779

ASSEMBLY INSTRUCTIONS
STEP 1

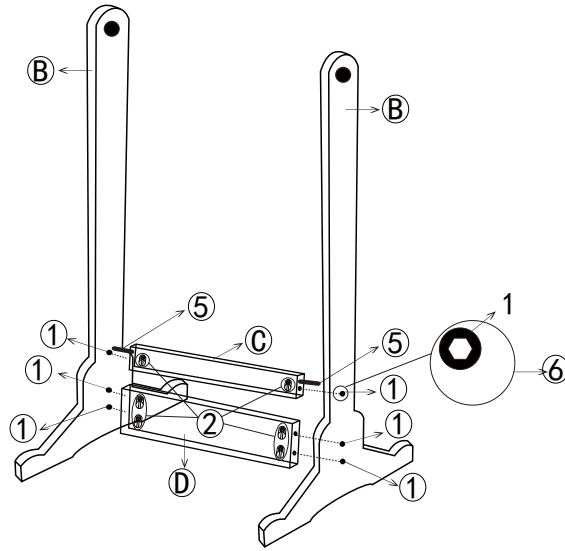

STEP 2

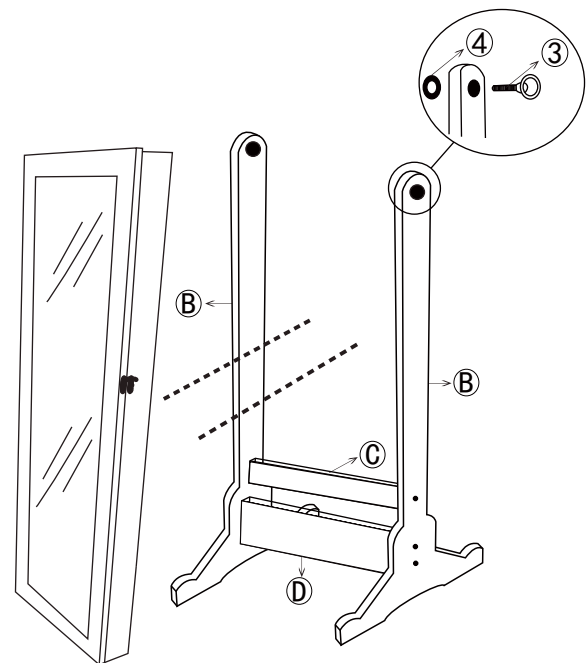

STEP 3

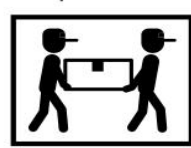
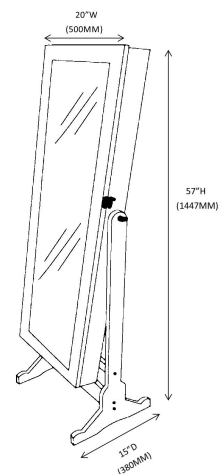

Note: Dimension tolerance ± 5