

*ASSEMBLY INSTRUCTIONS  
COASTER FINE FURNITURE*

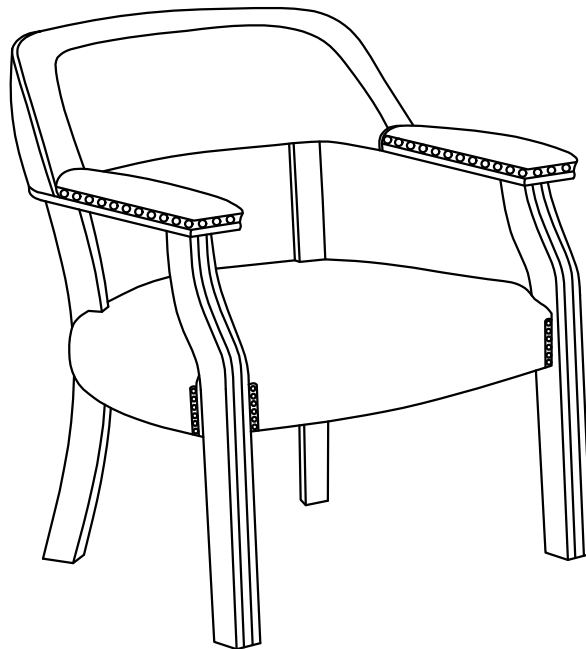

*Fine Furniture for every stage of life*

**411N**  
**Office Chair**

ITEM: **411N**

## ASSEMBLY INSTRUCTIONS

### ASSEMBLY TIPS:

1. Remove hardware from box and sort by size.
2. Please check to see that all hardware and parts are present prior to start of assembly.
3. Please follow attached instructions in the same sequence as numbered to assure fast & easy assembly.



### WARNING!





1. Don't attempt to repair or modify parts that are broken or defective. Please contact the store immediately.
2. This product is for home use only and not intended for commercial establishments.









ASSEMBLY TIME

15 MINUTES

## PARTS IDENTIFICATION

AV	BACKREST		1PC
BV	SEAT CUSHION WITH FRAME		1PC
CV	LEFT FRONT LEG		1PC
DV	RIGHT FRONT LEG		1PC
EV	BACK LEG		2PCS

## HARDWARE IDENTIFICATION

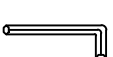
1	<b>LONG BOLT</b> ( Ø5/16" x 3-1/8" - RBW )		4PCS	6	<b>SHORT BOLT</b> ( Ø1/4" x 3/4" - BLK )		6PCS
2	<b>MEDIUM BOLT</b> ( Ø5/16" x 2" - RBW )		4PCS	7	<b>SMALL LOCK WASHER</b> ( Ø1/4" - BLK )		6PCS
3	<b>BIG LOCK WASHER</b> ( Ø5/16" - RBW )		8PCS	8	<b>SMALL FLAT WASHER</b> ( Ø1/4" - BLK )		6PCS
4	<b>BIG FLAT WASHER</b> ( Ø5/16" - RBW )		8PCS				
5	<b>ALLEN WRENCH</b> ( 4MM - RBW )		1PC				

ITEM: **411N**

**ASSEMBLY INSTRUCTIONS**

**STEP 1**

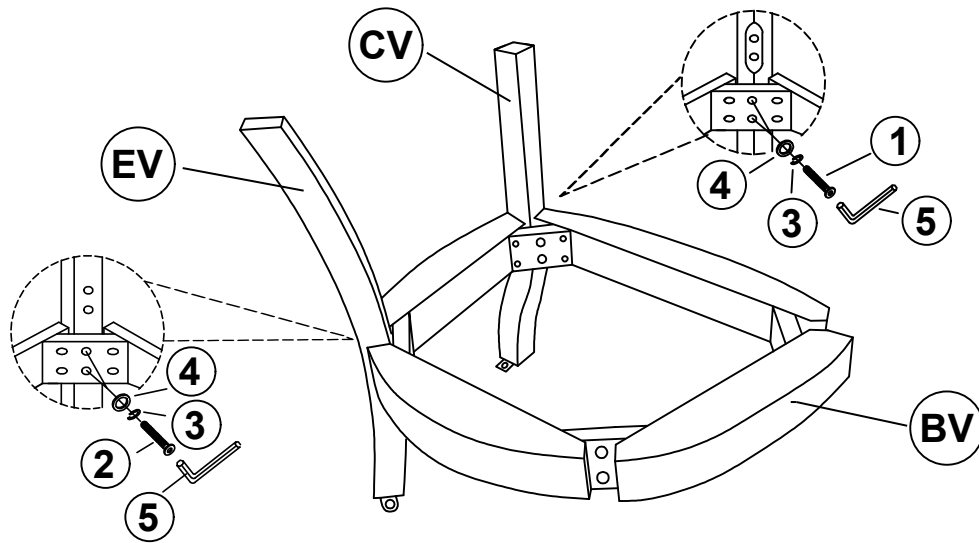

**STEP 2**

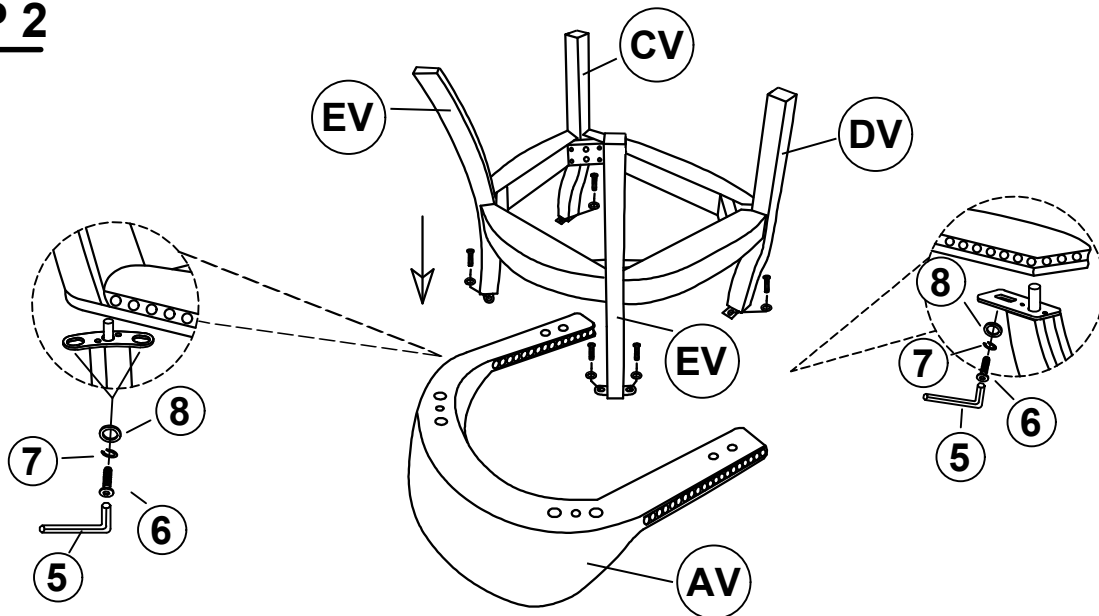

**STEP 3**  
**COMPLETE**

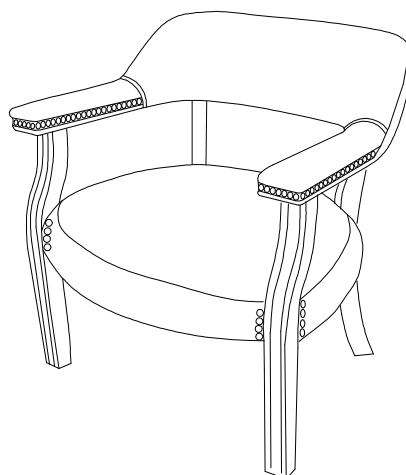

ITEM: 411N

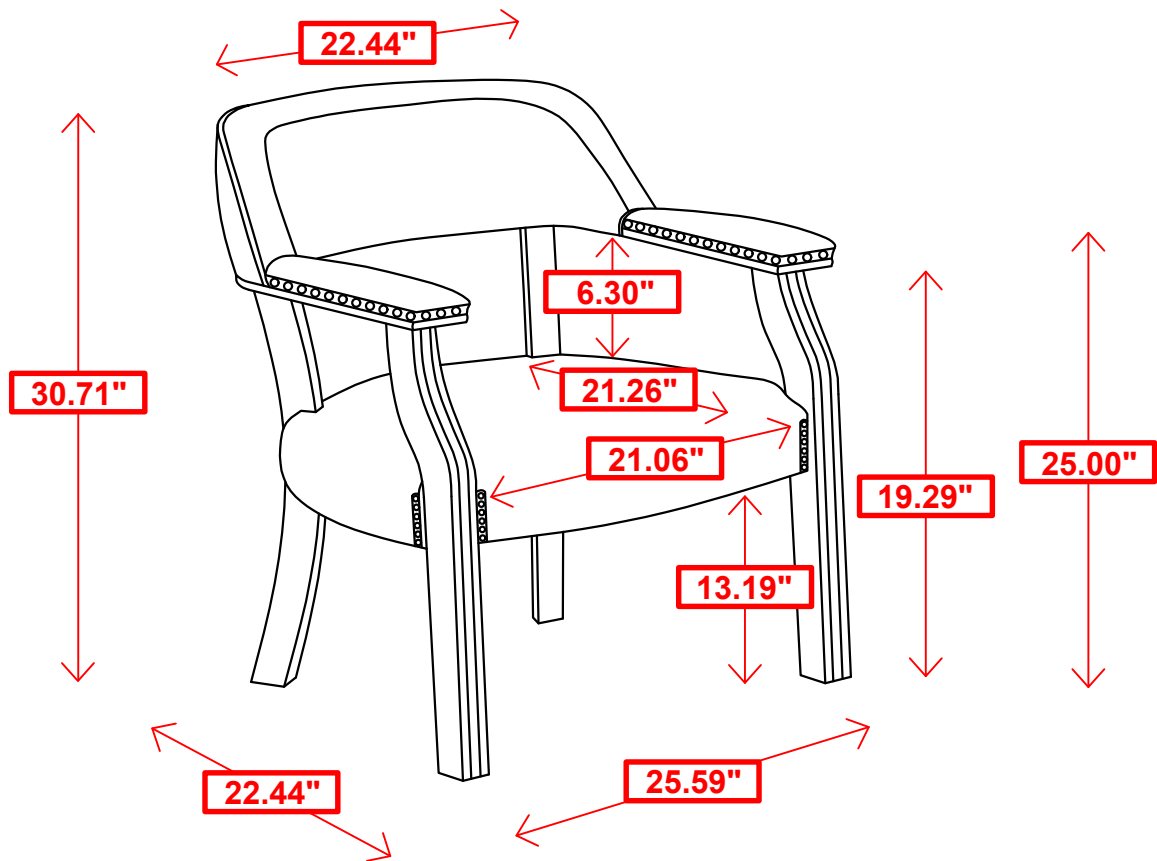

**Note:** Dimension tolerance  $\pm 5\%$