

**ASSEMBLY INSTRUCTIONS**  
**COASTER FINE FURNITURE**



*Fine Furniture for every stage of life*

**101930**  
***Bar Stool***

# ITEM: 101930



## ASSEMBLY INSTRUCTIONS

### ASSEMBLY TIPS:

1. Remove hardware from box and sort by size.
2. Please check to see that all hardware and parts are present prior to start of assembly.
3. Please follow attached instructions in the same sequence as numbered to assure fast & easy assembly.



### WARNING!





1. Don't attempt to repair or modify parts that are broken or defective. Please contact the store immediately.
2. This product is for home use only and not intended for commercial establishments.









ASSEMBLY TIME

10 MINUTES

## PARTS IDENTIFICATION

A	LEG		4PCS
B	FOOTREST		1PC
C	SWIVEL PLATE WITH FRAME		1PC
D	SEAT CUSHION WITH FRAME		1PC
E	BACKREST		1PC

## HARDWARE IDENTIFICATION

1	SHORT BOLT ( $\Phi 1/4$ " x 1" - BLK)		4PCS
2	MEDIUM BOLT ( $\Phi 1/4$ " x 1-4.5/8" - BLK)		8PCS
3	LONG BOLT ( $\Phi 1/4$ " x 1-3/4" - RBW)		6PCS
4	LOCK WASHER ( $\Phi 1/4$ " - BLK)		14PCS
5	FLAT WASHER ( $\Phi 1/4$ " - BLK)		14PCS
6	ALLEN WRENCH (4MM - BLK)		1PC

### NOTE:

Quantities shown are for one stool.

ITEM: **101930**



**ASSEMBLY INSTRUCTIONS**

**STEP 1**

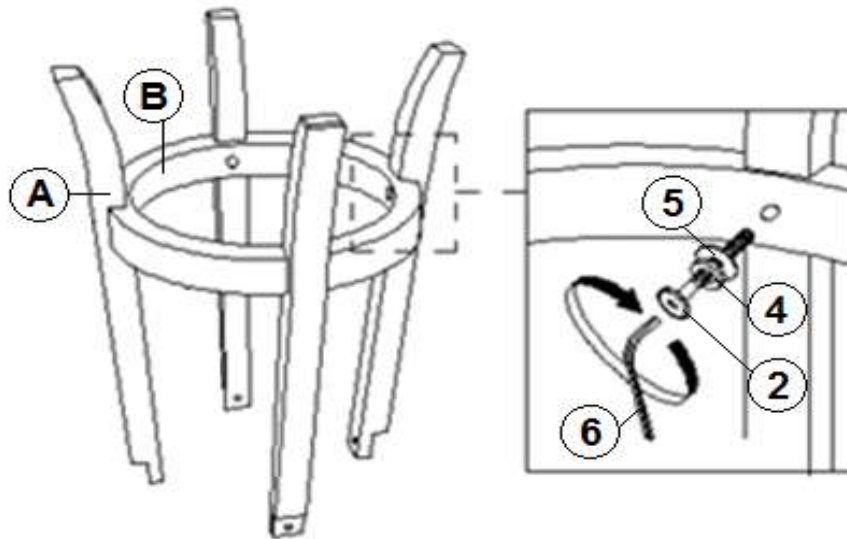

**STEP 2**

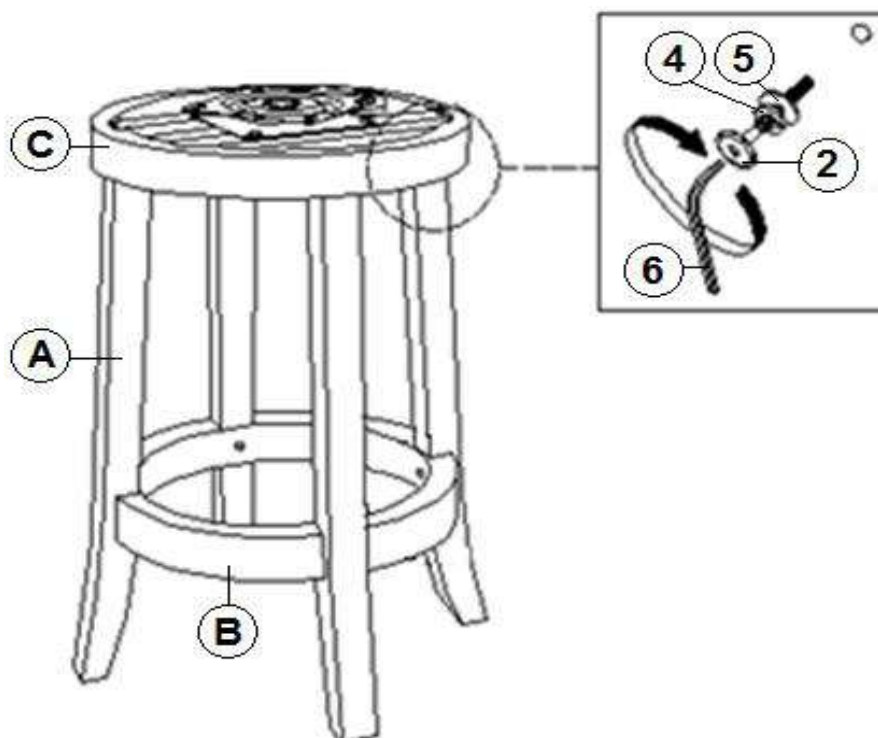

ITEM:101930

**ASSEMBLY INSTRUCTIONS**

**STEP 3**

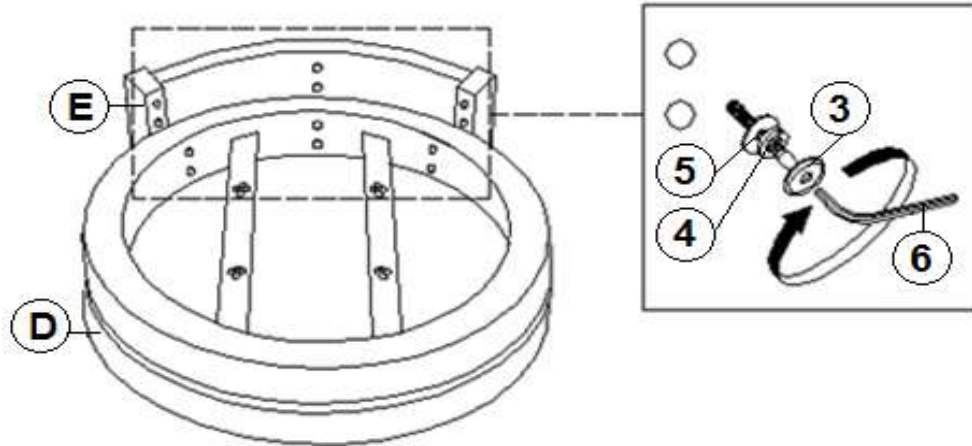

**STEP 4**

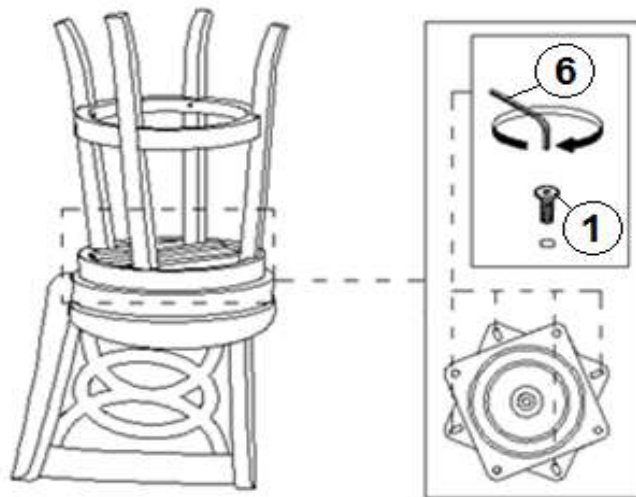

**STEP 5**  
**COMPLETE**

