



## ASSEMBLY INSTRUCTIONS COASTER FINE FURNITURE



*Fine Furniture for every stage of life*

**801140**  
**OFFICE CHAIR**

REVISION 0:11/21/2018  
REVISION 1:06/03/2019  
REVISION 2:11/5/2019  
REVISION 3:01/06/2020

PAGE 1 OF 4

COASTERFURNITURE.COM

ITEM :801140



# ASSEMBLY INSTRUCTIONS

## ASSEMBLY TIPS:

- 1.Remove hardware from box and sort by size.
- 2.Please check to see that all hardware and parts are present prior to start of assembly.
- 3.Please follow attached instructions in the same sequence as numbered to assure fast & easy assembly.











### WARNING !

- 1.Don't attempt to repair or modify parts that are broken or defective. Please contact the store immediately.
- 2.This product is for home uses only and not intended for commercial establishments.



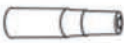



ASSEMBLY TIME 20 MINUTES

## PARTS IDENTIFICATION

A		BACK	1PC
B		SEAT	1PC
C		RIGHT ARM	1PC
D		LEFT ARM	1PC
E		MECHANISM	1PC
F		GAS LIFT COVER	1PC
G		GAS LIFT	1PC
H		BASE	1PC
I		CASTER	5PCS

## HARDWARE IDENTIFICATION

NO	DESCRIPTION	FIGURE	Q'TY
1	LONG BOLT	 M6*25	8PCS
2	SHORT BOLT	 M6*20	4PCS
3	ALLEN WRENCH	 M6	1PC
4	CAP		8PCS
5	WASHER	 M6*18*1.2	4PCS

ITEM:801140



# ASSEMBLY INSTRUCTIONS

## STEP1

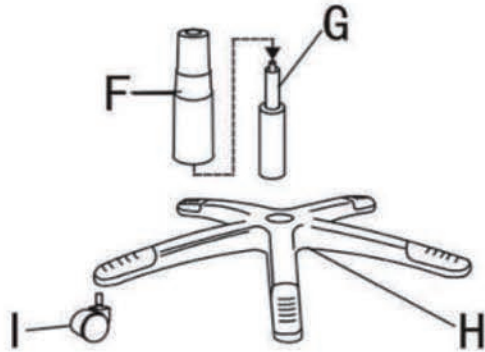

## STEP2

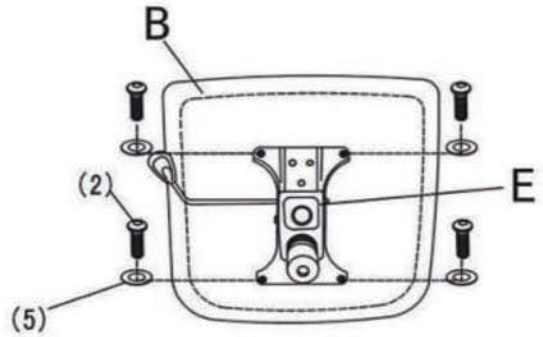

## STEP3

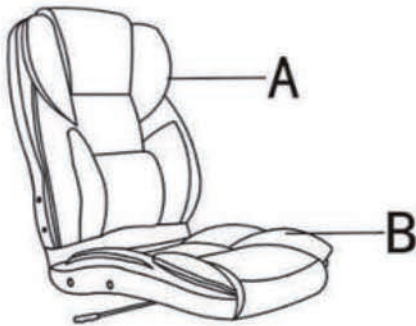

## STEP4



## STEP5



## STEP6

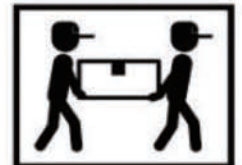

ITEM :801140



Note : Dimension tolerance  $\pm 5\%$