

ASSEMBLY INSTRUCTIONS
COASTER FINE FURNITURE



Fine Furniture for every stage of life

920065
FLOOR LAMP

REVISION 0 : 05/07/2019

ITEM :920065



Assembly Instructions













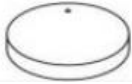

ASSEMBLY TIPS:

1. Remove hardware from box and sort by size.
2. Please check to see that all hardware and parts are present prior to start of assembly.
3. Please follow attached instructions in the same sequence as numbered to assure fast & easy assembly.

Warning!

-  1. Don't attempt to repair or modify parts that are broken or defective. Please contact the store immediately.
2. This product is for home use only and not intended for commercial establishments.

PARTS IDENTIFICATION

NO	DESCRIPTION	FIGURE	Q,TY	NO	DESCRIPTION	FIGURE	Q,TY
A	BOTTOM POLE		1 PC				
B	MIDDLE POLE		1 PC	F	PLATE		1 PC
C	TOP POLE		1 PC	G	TOOTH TUBE		1 PC
D	ARM		1 PC	H	WASHER		1 PC
E	BASE		1 PC	I	WASHER		1 PC
F	SHADE		1 PC	J	NUT		1 PC
G	LIGHT BULB		1 PC	K	WRENCH		1 PC
				L	SCREW		1 PC
				M	RUNG		1 PC

ITEM :920065



Assembly Instructions

STEP1

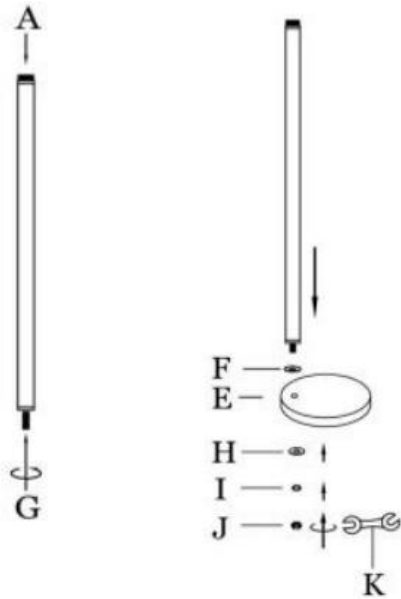

STEP2

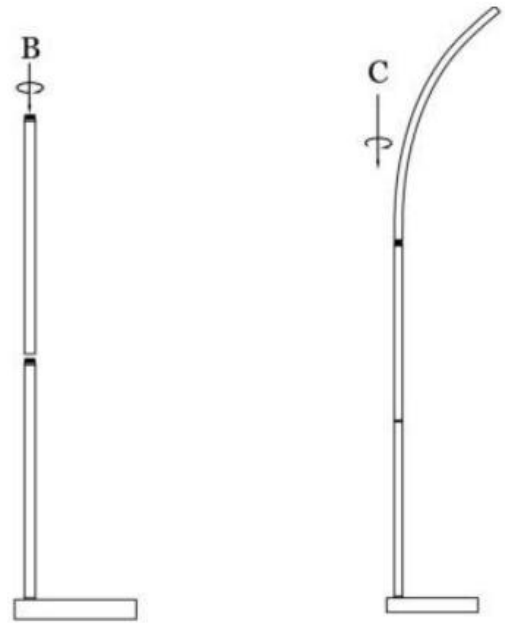

STEP3

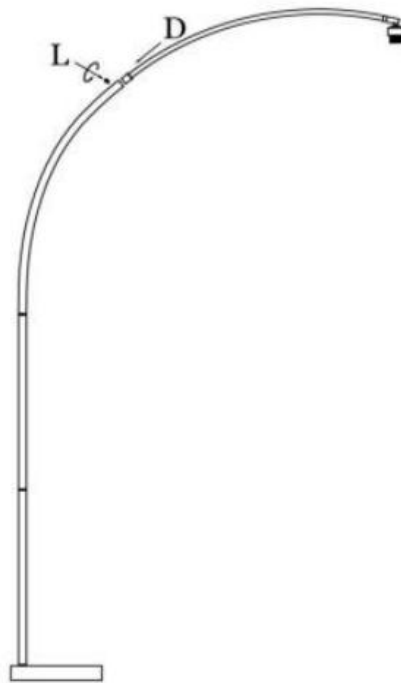

STEP4

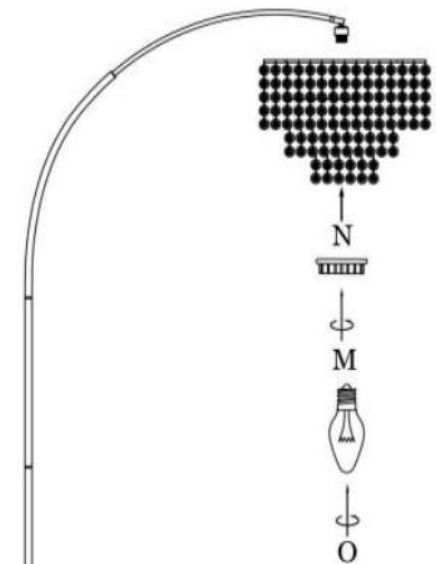

As a safety feature, and to reduce the risk of electric shock, this portable lamp includes a polarized plug (one blade is wider than the other). The plug will fit into a polarized outlet in a single direction only. If the plug does not fit fully in the outlet, reverse the plug and try again. If it still does not fit, contact a qualified electrician. DO NOT use with an extension cord unless, can be fully inserted. DO NOT alter the plug.

FLOOR LAMP:TYPE A LED BULB 9W

ITEM :920065

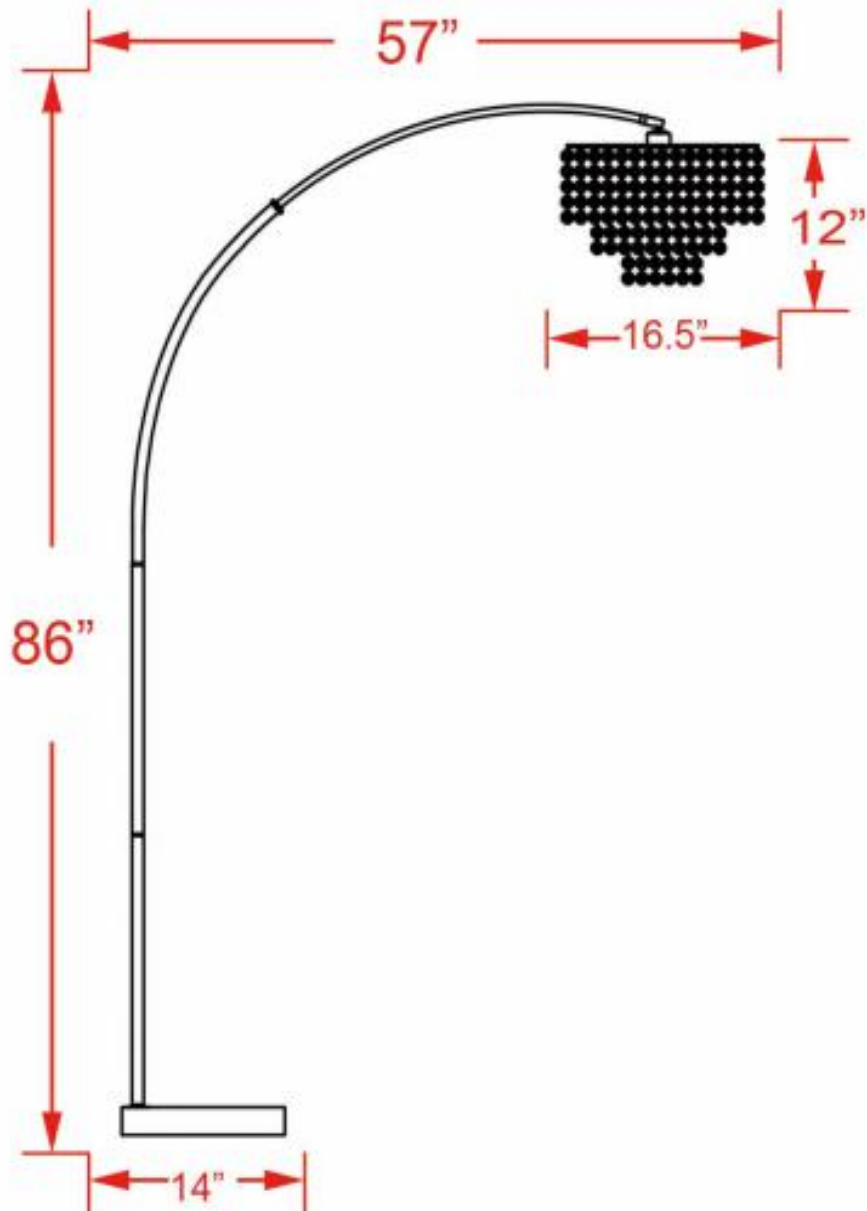

Note : Dimension tolerance $\pm 5\%$