

ASSEMBLY INSTRUCTIONS
COASTER FINE FURNITURE



Fine Furniture for every stage of life

801137
BOOKCASE

ITEM:801137

ASSEMBLY INSTRUCTIONS

ASSEMBLY TIPS:

1. Remove hardware from box and sort by size.
2. Please check to see that all hardware and parts are present prior to start of assembly.
3. Please follow attached instructions in the same sequence as numbered to assure fast & easy assembly.



WARNING!

1. Don't attempt to repair or modify parts that are broken or defective. Please contact the store immediately.
2. This product is for home use only and not intended for commercial establishments.



ASSEMBLY TIME

40 MINUTES

PARTS IDENTIFICATION

A	SIDE PANEL		2PCS	E	LOWER SHELF		2PCS
B	LARGE CROSS PANEL		2PCS	F	LOWER DIVIDER PANEL		2PCS
C	SMALL CROSS PANEL		2PCS	G	MIDDLE DIVIDER PANEL		2PCS
D	UPPER SHELF		2PCS	H	UPPER DIVIDER PANEL		1PC

HARDWARE IDENTIFICATION

Z	NO	DESCRIPTION	FIGURE	Q'TY	NO	DESCRIPTION	FIGURE	Q'TY
	1	GLUE 40g		1 PC	4	CAM BOLT Ø 7x35.5mm		24PCS
	2	WOODEN DOWEL Ø 8x30mm		44PCS	5	BOLT Ø 9.5x55mm		20PCS
	3	CAM LOCK Ø 15x12mm		24PCS	6	STICKER Ø 20mm		8PCS

NOTE:

Phillips head screw driver is required in the assembly process; however, manufacturer does not provide this item.

STEP 1

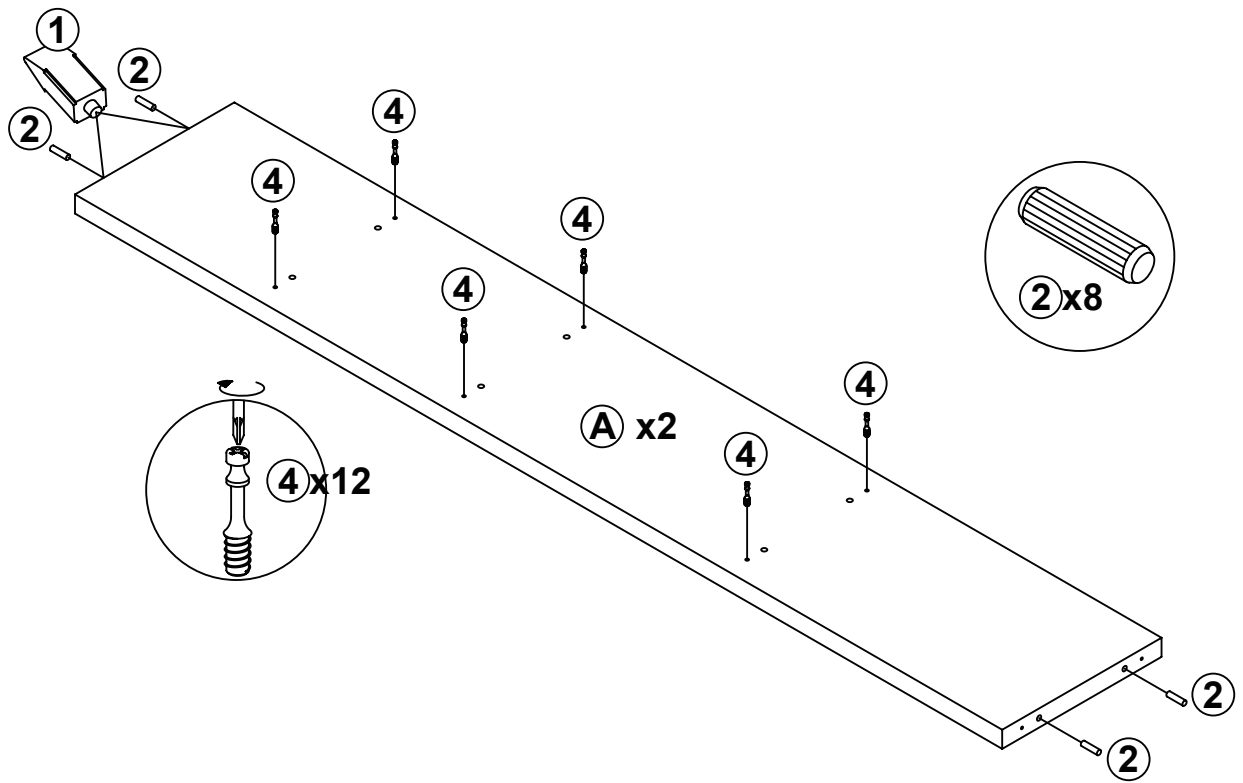

STEP 2

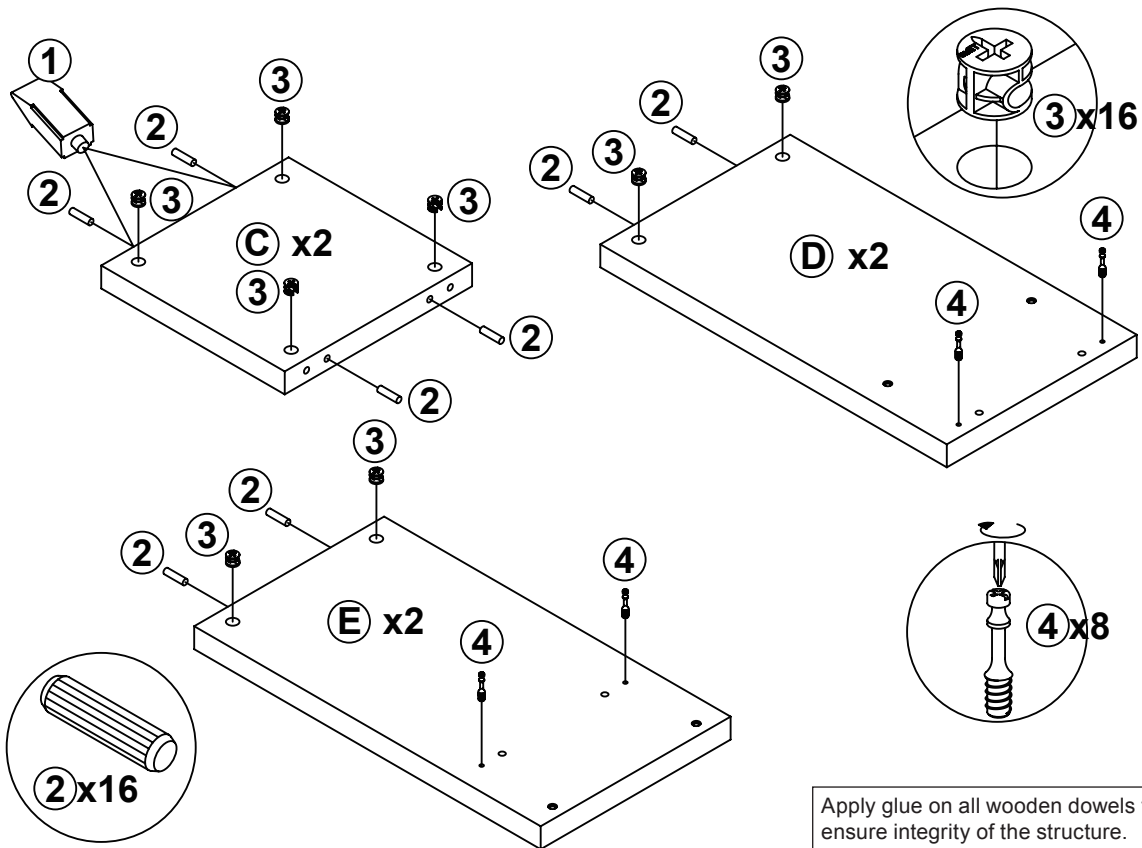

STEP 3

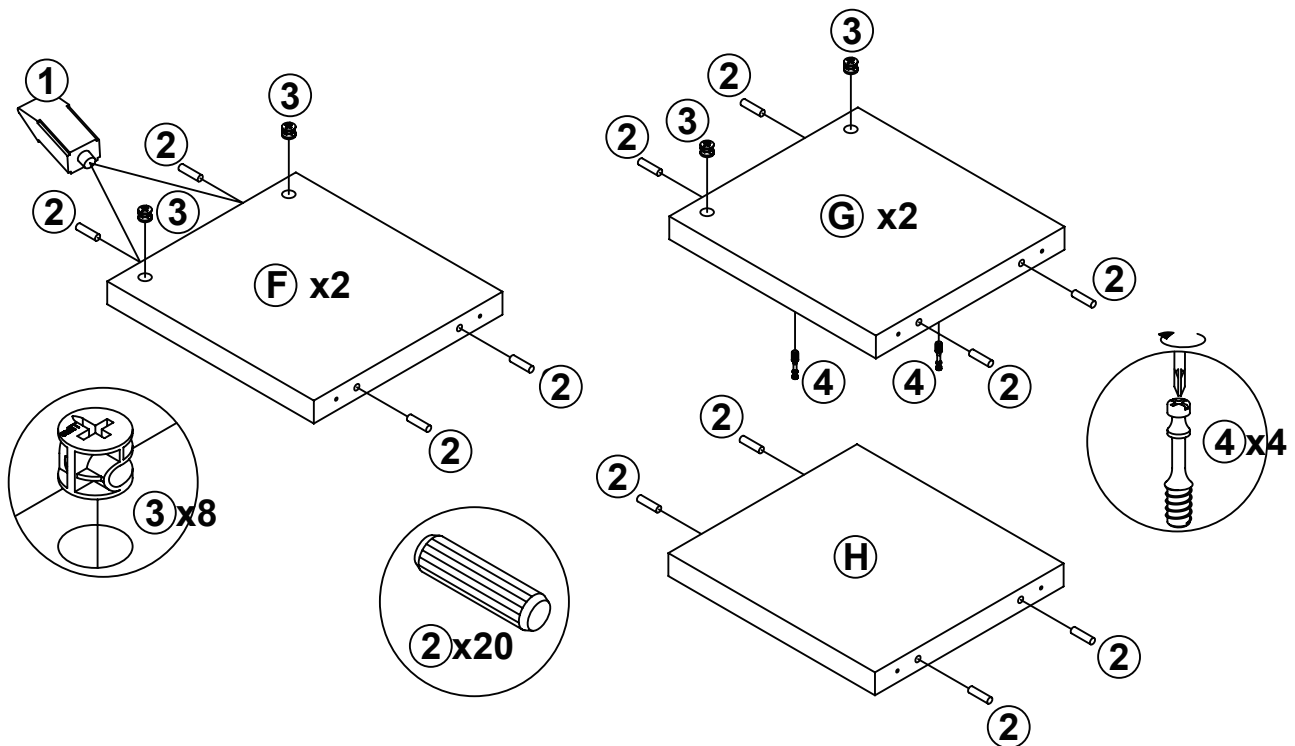

Apply glue on all wooden dowels to ensure integrity of the structure.

STEP 4

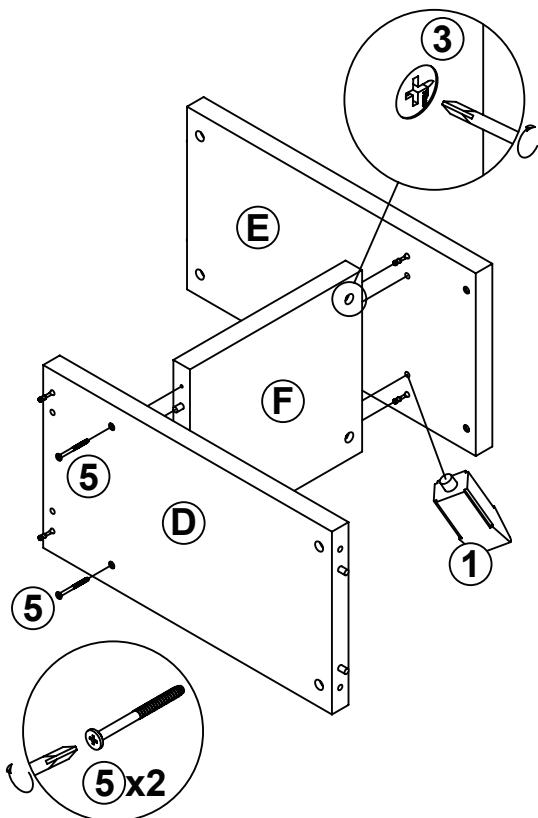

STEP 5

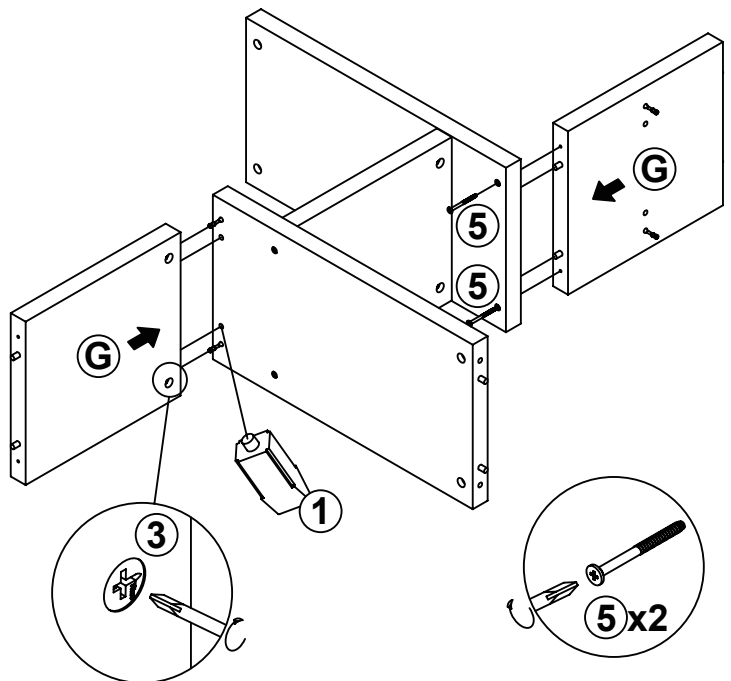

Apply glue on all wooden dowels to ensure integrity of the structure.

STEP 6

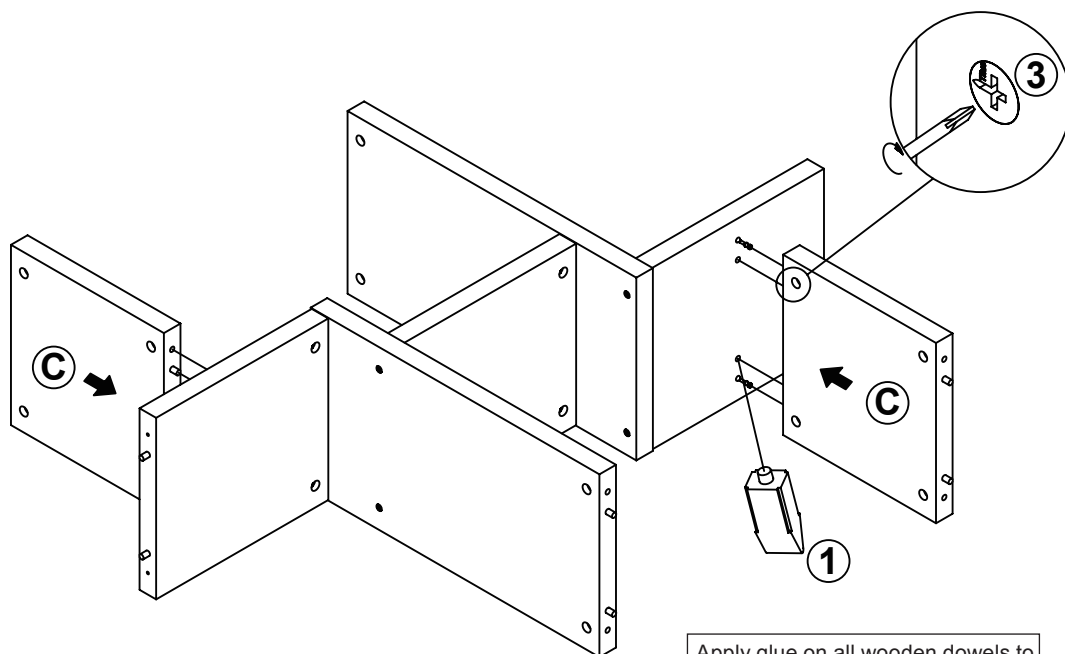

Apply glue on all wooden dowels to ensure integrity of the structure.

STEP 7

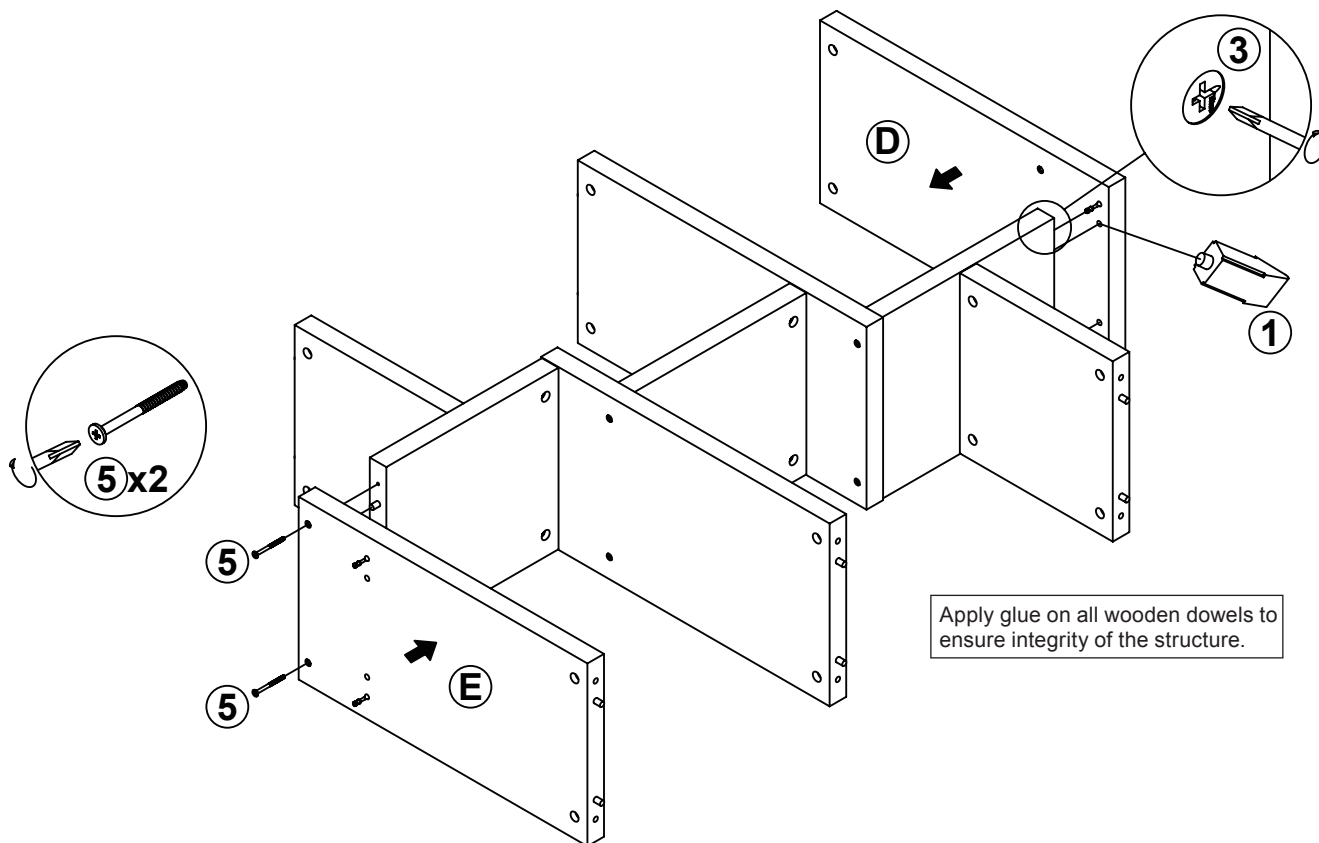

Apply glue on all wooden dowels to ensure integrity of the structure.

ITEM: 801137

STEP 8

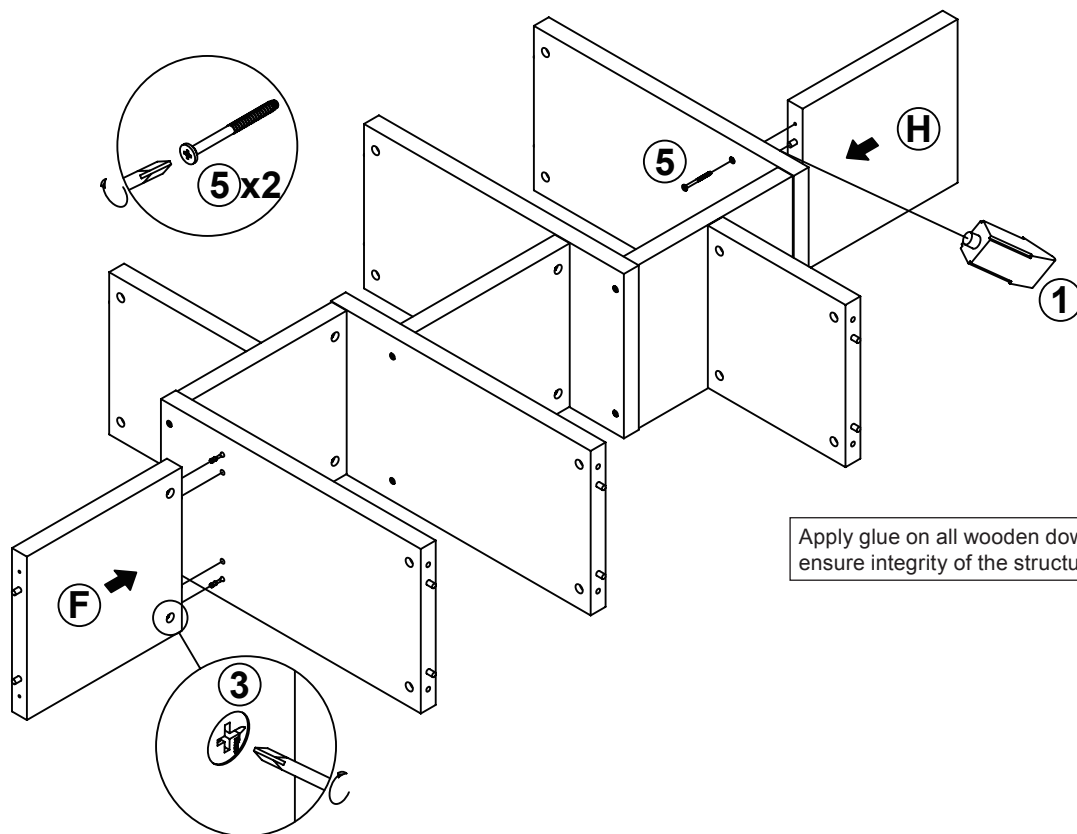

STEP 9

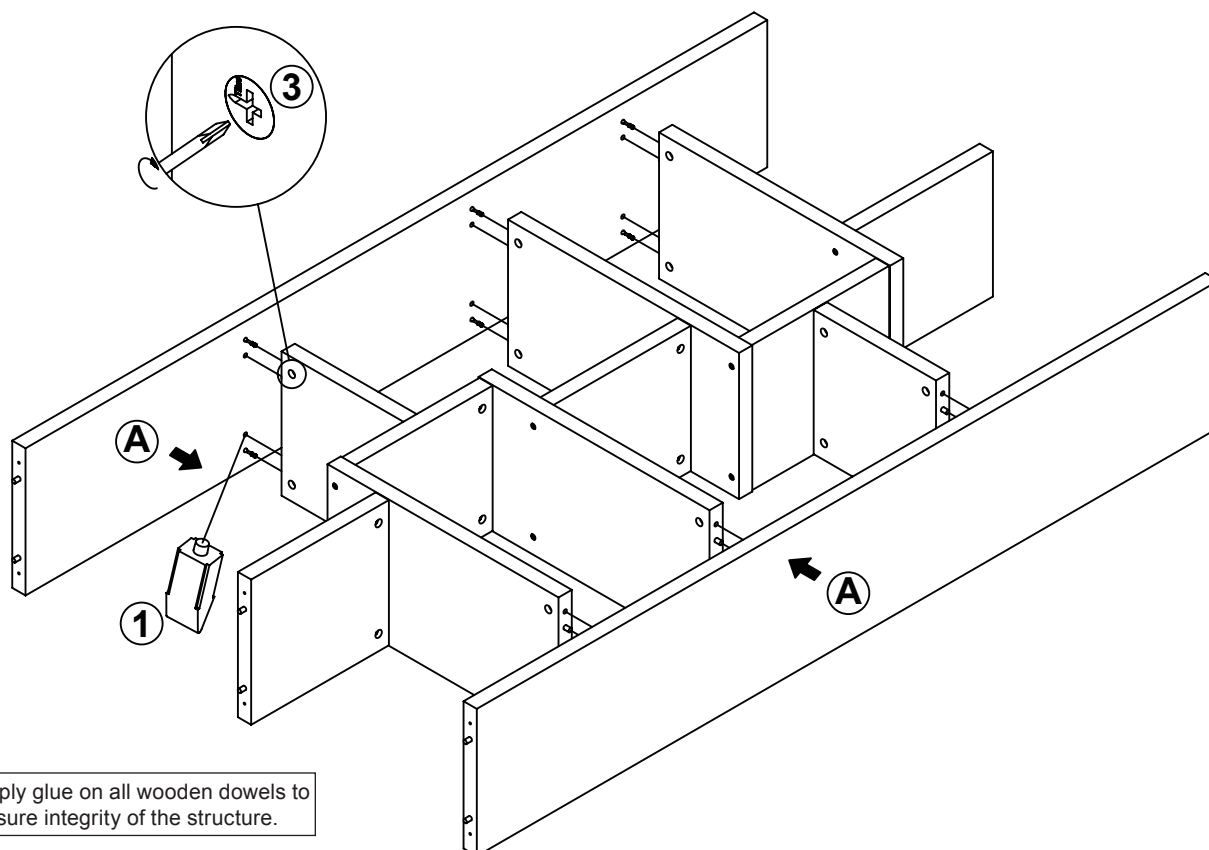

ITEM: 801137

STEP 10

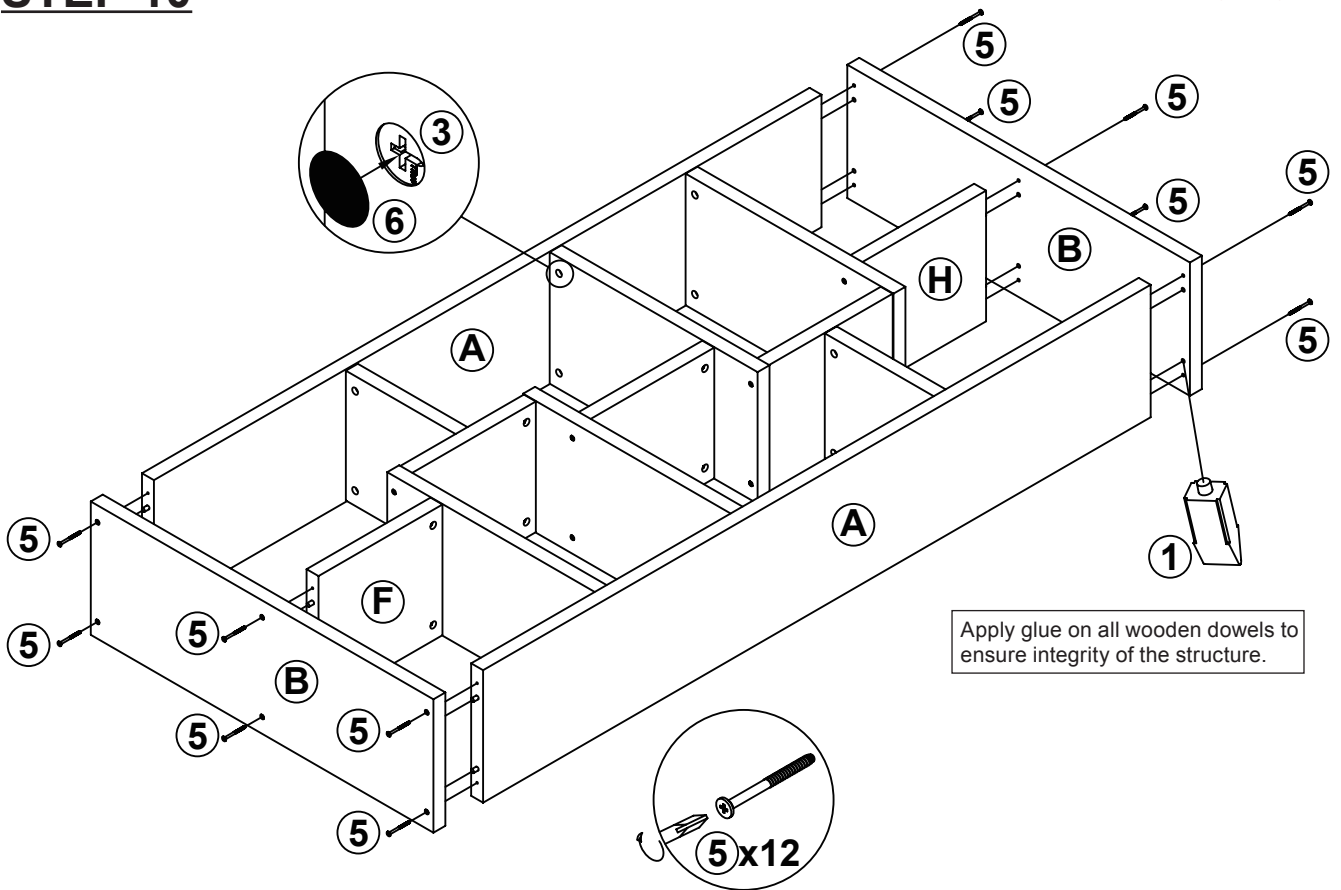

STEP 11

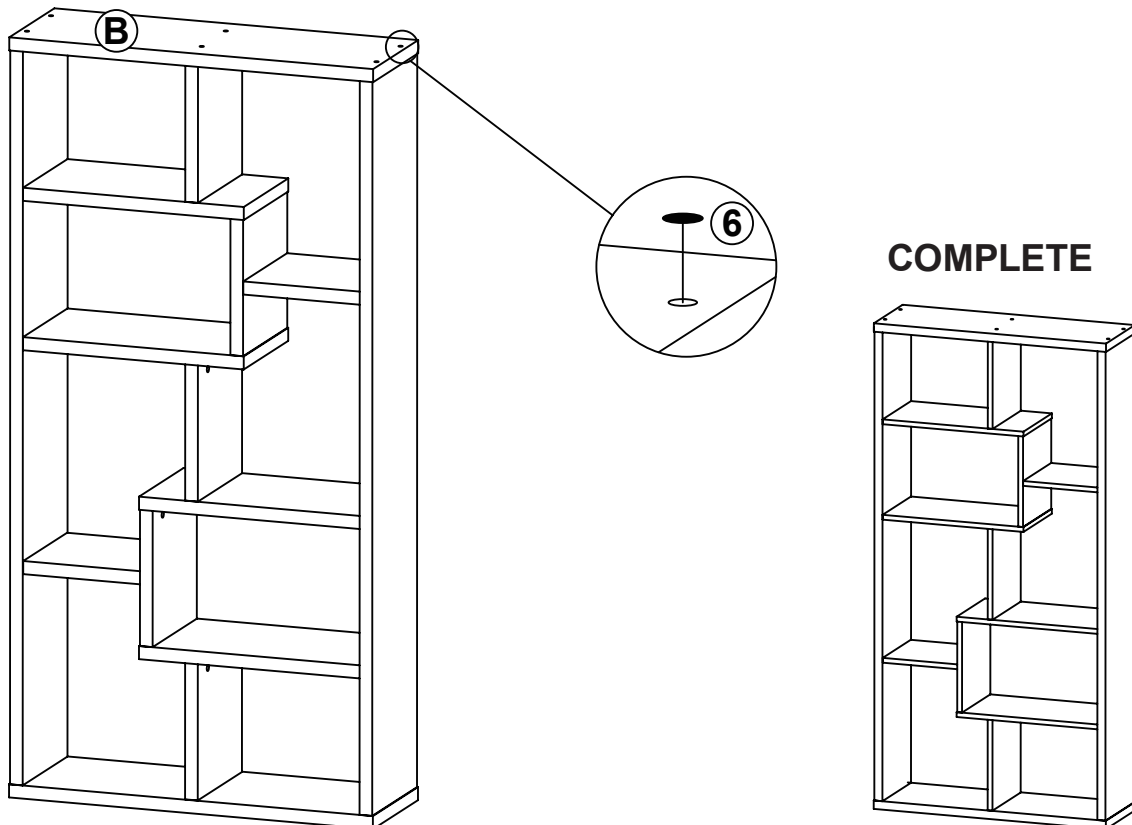

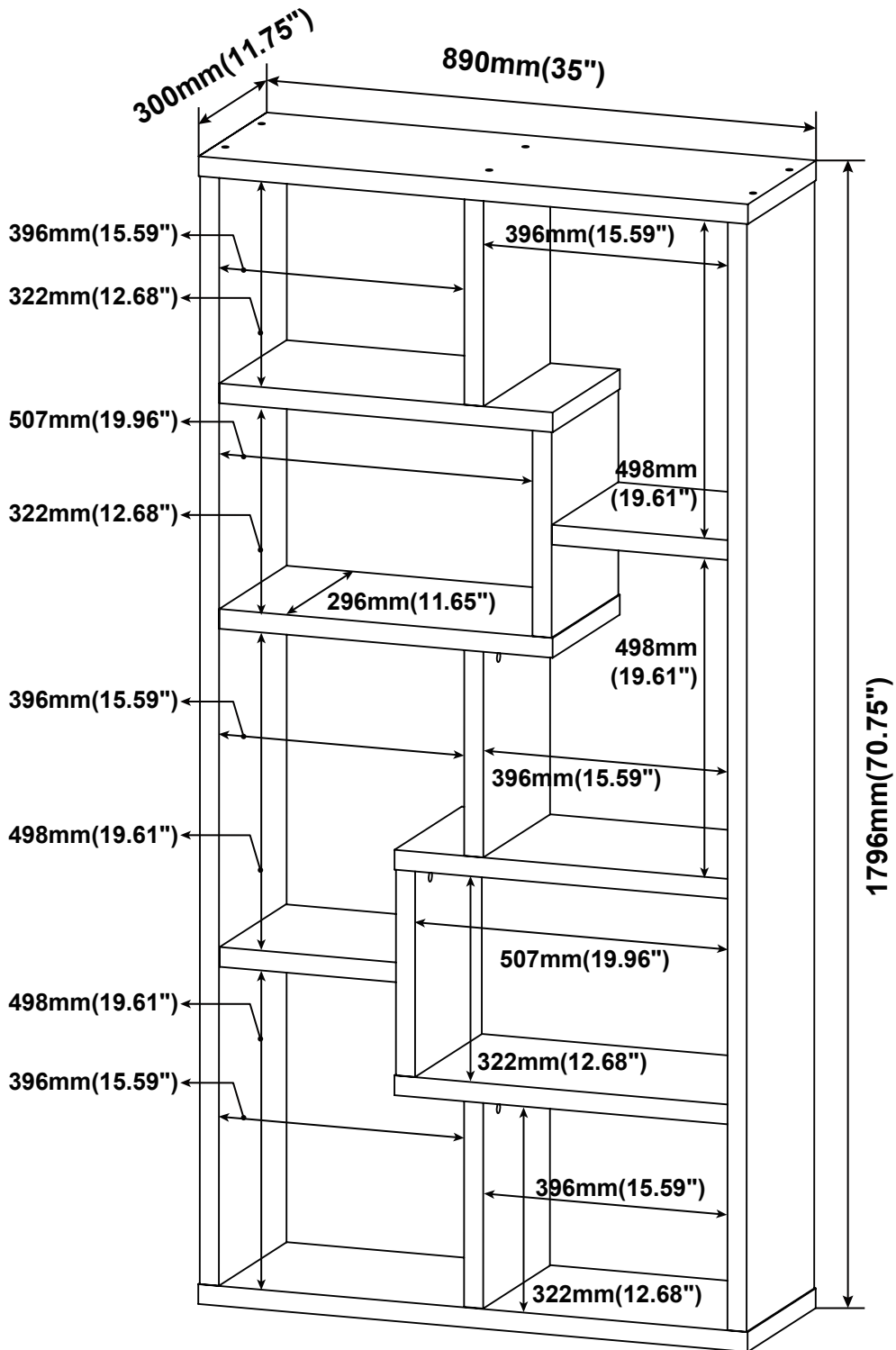

Note : Dimension tolerance $\pm 5\%$

ANTI-TIPPING INSTALLMENT INSTRUCTIONS

FURNITURE TIPPING RESTRAINT

WARNING

Injury may result from tipping furniture.
This restraint may protect against tipping furniture.
Do not allow children to climb on furniture.
This restraint is not a substitute for proper adult supervision.
Failure to detach this restraint before moving the furniture
may result in injury and damage.

1. To attach the anti-tip strap, securely mount one end to the top of the case piece with the 5/8" screw.
2. Position the case piece against the wall in the desired location.
3. Pull the anti-tip strap taut and mark the position of where you will secure the other end on the wall.
4. Drill a 1-1/4" hole in the spot you marked.
5. Tap in plastic wall plug.
6. Fasten anti-tip strap with wall screw provided.

(Please install the anti-tipping kit in the middle of the case piece if only have one set of anti-tipping kit.)

