

COASTER®

Fine Furniture

506582
LOVESEAT

ASSEMBLY INSTRUCTION

COASTER FINE FURNITURE



WWW.COASTERCOMPANY.COM

2017/05/12

Assembly Instruction

ASSEMBLY TIPS:

- 1.Remove hardware from box and sort by size
- 2.Please check to see that all hardware and parts are present prior to start of assembly
- 3.Please follow attached instructions in the same sequence as numbered to assure fast & easy assembly.



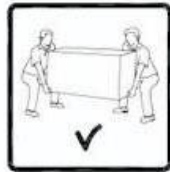

Warning!

- 1.Do not attempt to repair or modify parts that are broken or defective, Please contact the store immediately.
- 2.This product is for home use only and not intended for commercial establishment.

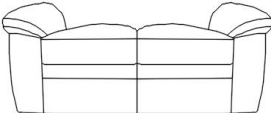
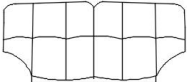

ASSEMBLY TIME PER UNIT: 15 MINUTES

PAPTS IDENTIFICATION

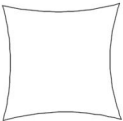
- | | | |
|-----|---|-------------|
| (A) |  | SEAT 1PC |
| (B) |  | BACK 1PC |
| (C) |  | LEG 4PCS |
| (D) |  | PILLOW 2PCS |

Z HARDWAREPACKAGE

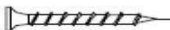
NO	DESCRIPTION	FIGURE	Q'TY
(1)	SCREW		12PCS

STEP 1

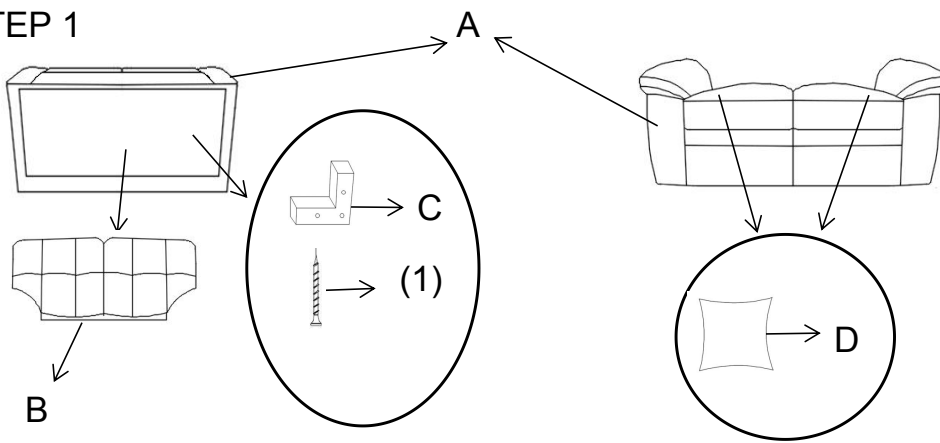

STEP 2

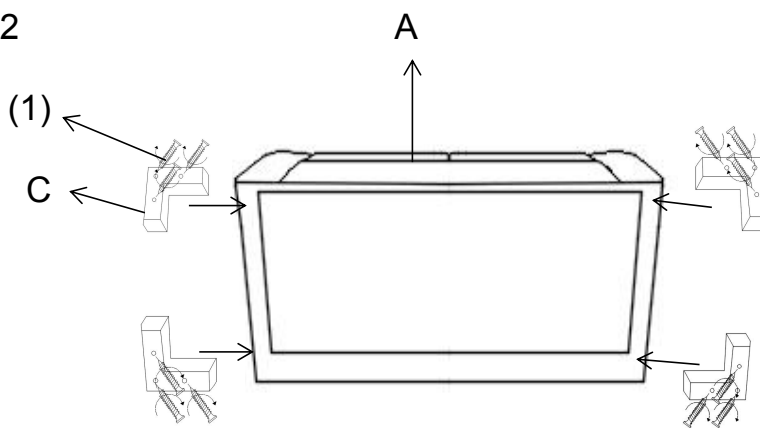

STEP 3

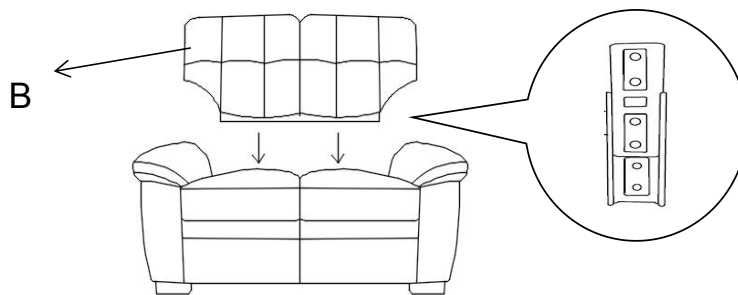

STEP 4

