

ASSEMBLY INSTRUCTIONS
COASTER FINE FURNITURE



Fine Furniture for every stage of life

931147
ACCENT TABLE

REVISION 0 : 06/03/2019
REVISION 1 : 08/22/2019

ITEM:931147



ASSEMBLY INSTRUCTIONS

ASSEMBLY TIPS:

1. Remove hardware from box and sort by size.
2. Please check to see that all hardware and parts are present prior to start of assembly.
3. Please follow attached instructions in the same sequence as numbered to assure fast & easy assembly.



WARNING!



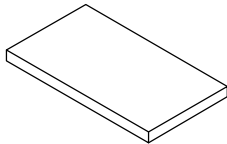
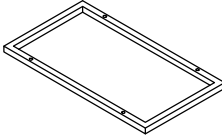
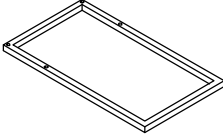
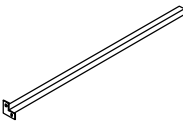
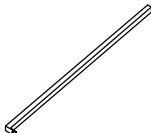

1. Don't attempt to repair or modify parts that are broken or defective. Please contact the store immediately.
2. This product is for home use only and not intended for commercial establishments.

ASSEMBLY TIME 35 MINUTES

PARTS IDENTIFICATION

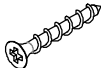
A	TOP		1PC
B	TOP FRAME		1PC
C	BOTTOM FRAME		1PC
D	LEG		2PCS
E	SUPPORT LEG		2PCS

HARDWARE IDENTIFICATION

1	SMALL BOLT (3/16" x 12mm BLK)		6PCS	4	SCREW (8# x 1-1/4" BLK)		4PCS
2	SHORT BOLT (1/4" x 22mm BLK)		2PCS	5	SUCTION CUP (ø6.3mm)		4PCS
3	LONG BOLT (1/4" x 38mm BLK)		2PCS	6	ALLEN WRENCH (4mm)		1PC

ITEM: 931147 ASSEMBLY INSTRUCTIONS



STEP 1 Do not tighten until each step is completed or instructed.

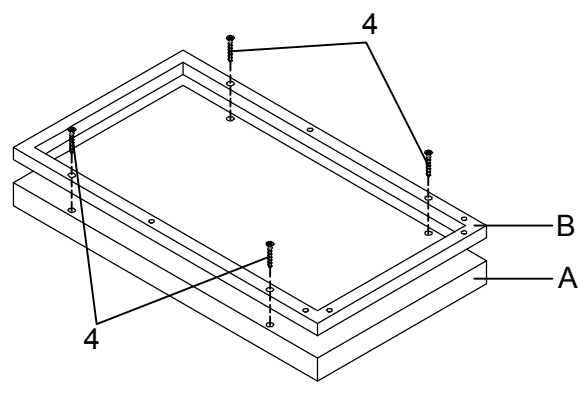

STEP 2

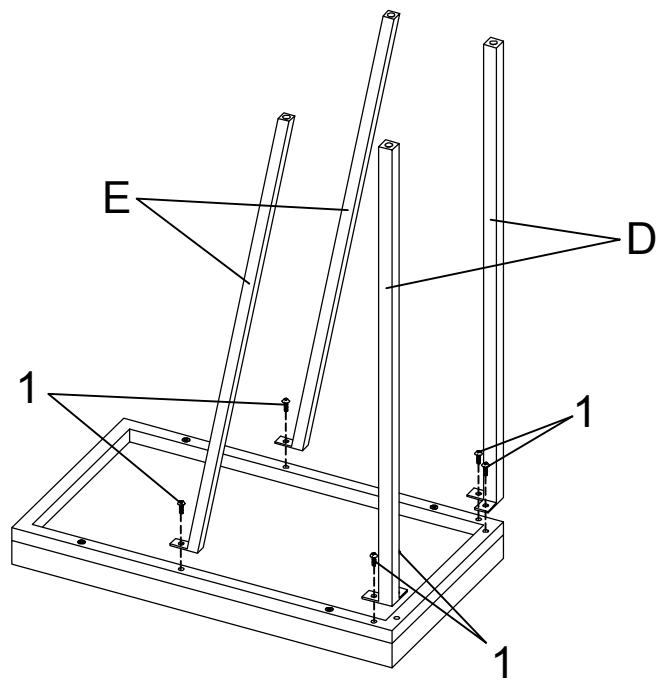

ITEM: 931147
ASSEMBLY INSTRUCTIONS



STEP 3

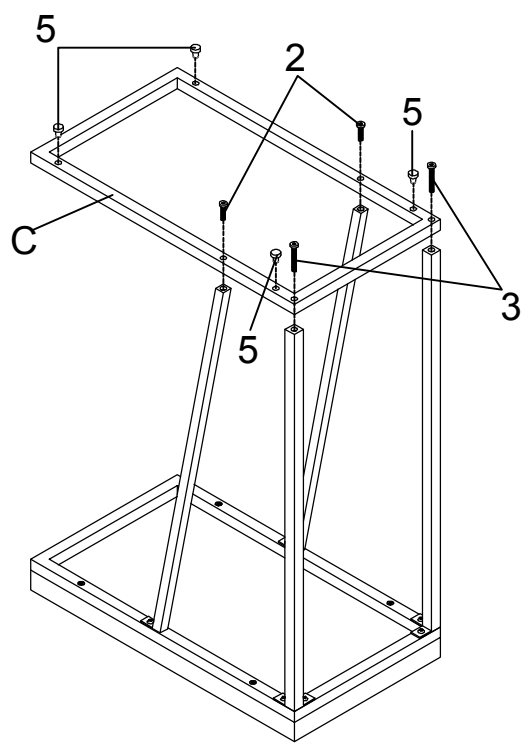

STEP 4
COMPLETE

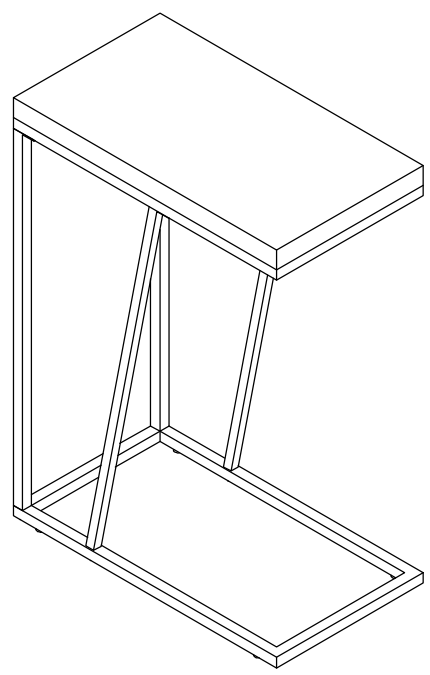

ITEM:931147 ASSEMBLY INSTRUCTIONS



Product Size : 254 X 457 X 635 H (MM)
Product Size : 10" X 18" X 25"

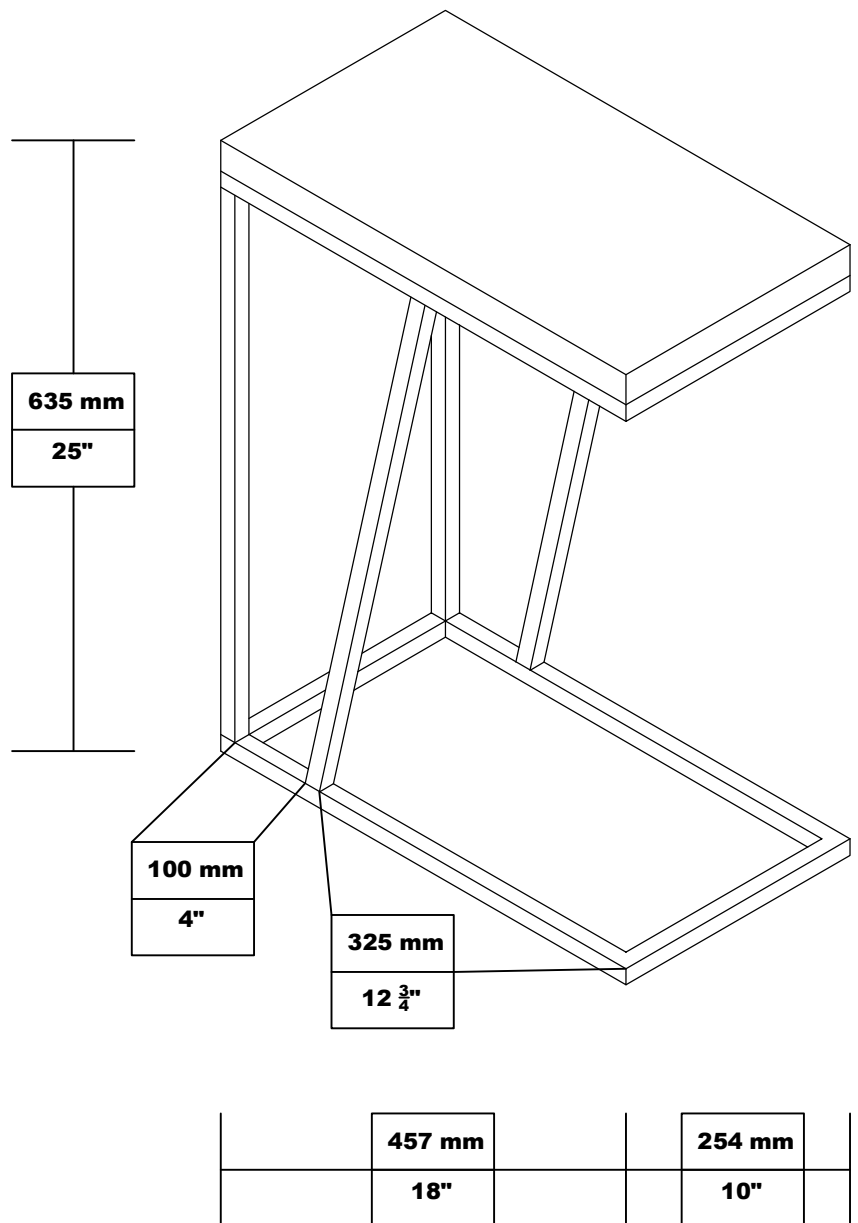

Note : Dimension tolerance $\pm 5\%$