

ASSEMBLY INSTRUCTIONS
COASTER FINE FURNITURE



Fine Furniture for every stage of life

950803
CHEVAL MIRROR

ITEM: **950803**



ASSEMBLY INSTRUCTIONS

ASSEMBLY TIPS:

1. Remove hardware from box and sort by size.
2. Please check to see that all hardware and parts are present prior to start of assembly.
3. Please follow attached instructions in the same sequence as numbered to assure fast & easy assembly.







WARNING!

1. Don't attempt to repair or modify parts that are broken or defective. Please contact the store immediately.
2. This product is for home use only and not intended for commercial establishments.



ASSEMBLY TIME

15 MINUTES

PARTS IDENTIFICATION

A	MIRROR		1PC
B	POST		2PCS
C	CROSS BRACE		1PC
D	LEG		4PCS
E	WOODEN KNOB WITH BOLT		2PCS

HARDWARE IDENTIFICATION

1	BRASS EYEBOLT (5/16" x 95mm BLK)		2PCS
2	BOLT (1/4" x 64mm BLK)		4PCS
3	WASHER (Ø21mm BLK)		2PCS

ITEM: **950803**

ASSEMBLY INSTRUCTIONS
STEP 1

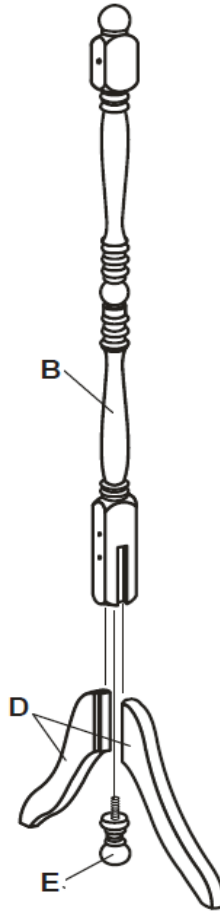

STEP 2

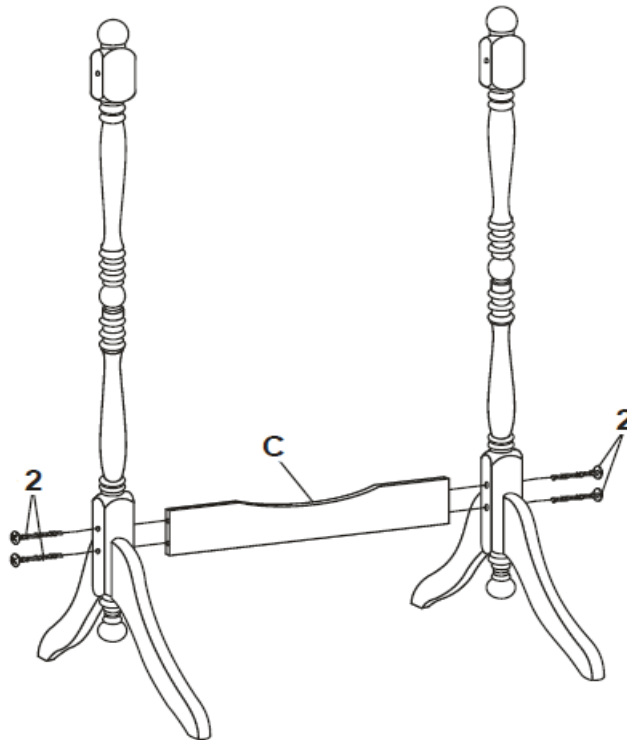

ITEM: **950803**

ASSEMBLY INSTRUCTIONS
STEP 3

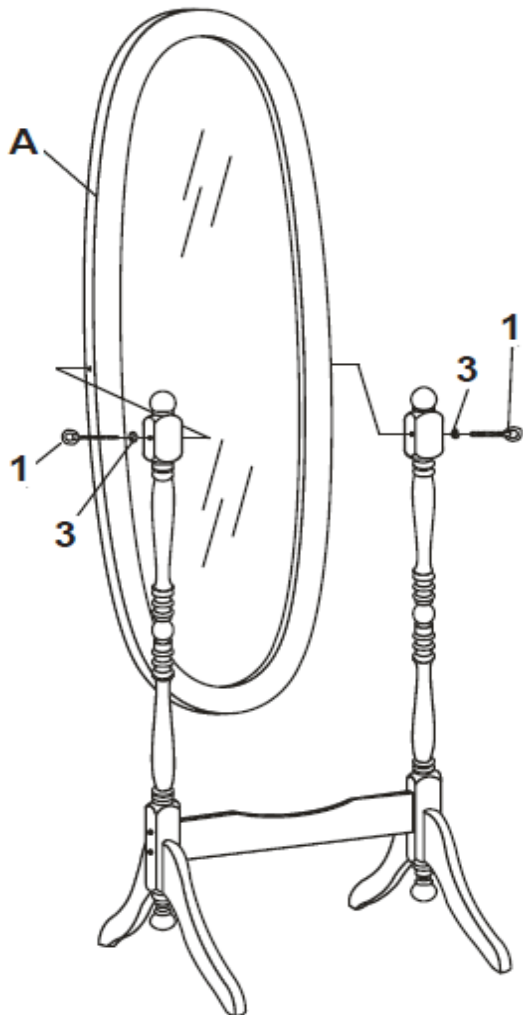

COASTER
FINE FURNITURE

STEP 4
COMPLETE

