

ASSEMBLY INSTRUCTIONS

INSTRUCCIONES

Do not tighten screws until completely Assembled
 No apretar los tornillos hasta armar completamente

PARTS LIST/LISTA DE PARTES					
A 8Pcs/8PIEZAS	B 1Pc/1PIEZAS	C 4Pcs/4PIEZAS	D 8Pcs/8PIEZAS	E 4Pcs/4PIEZAS	F 1Pc/1PIEZAS
 Ø5/16"*2-1/2"	 5/16"		 Ø8#*3/4"		

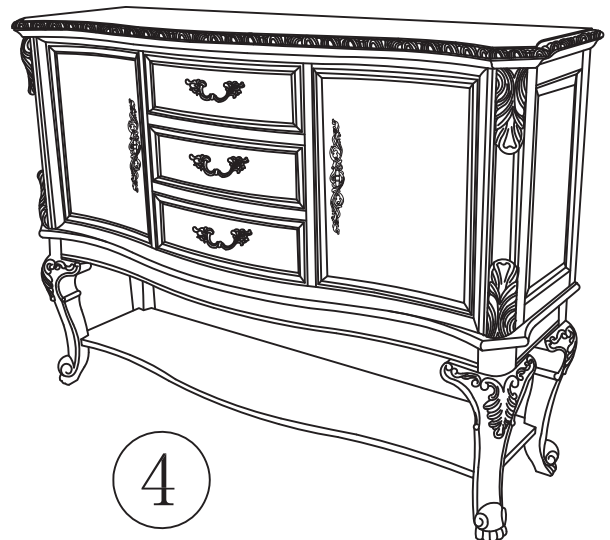
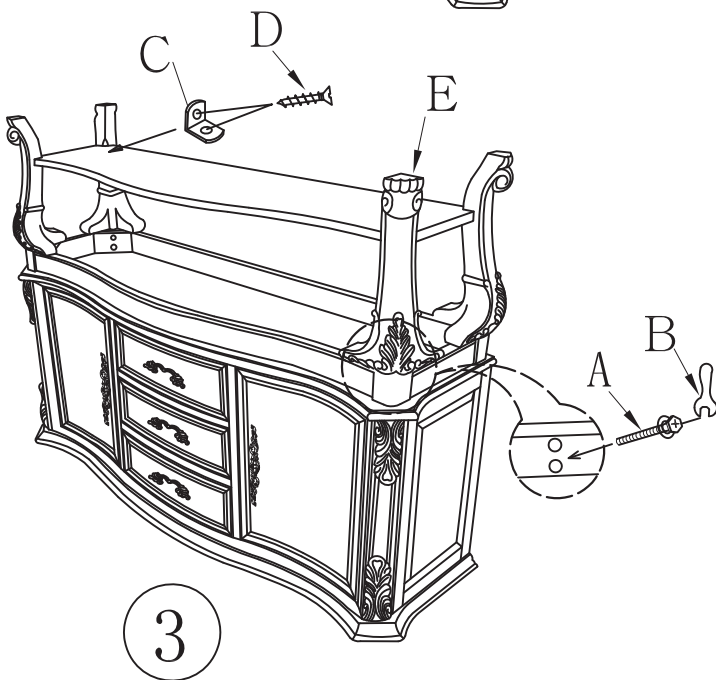
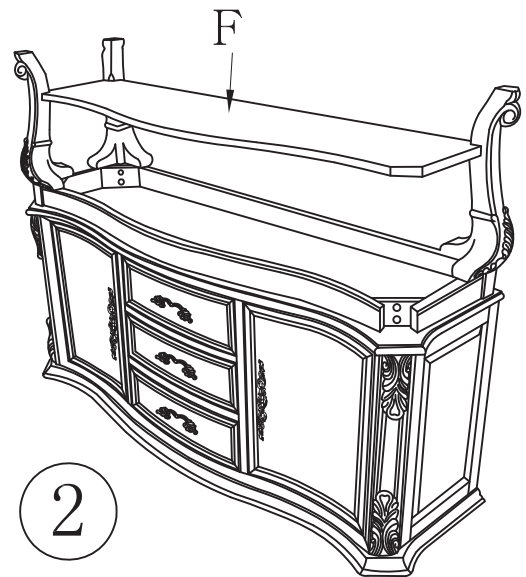
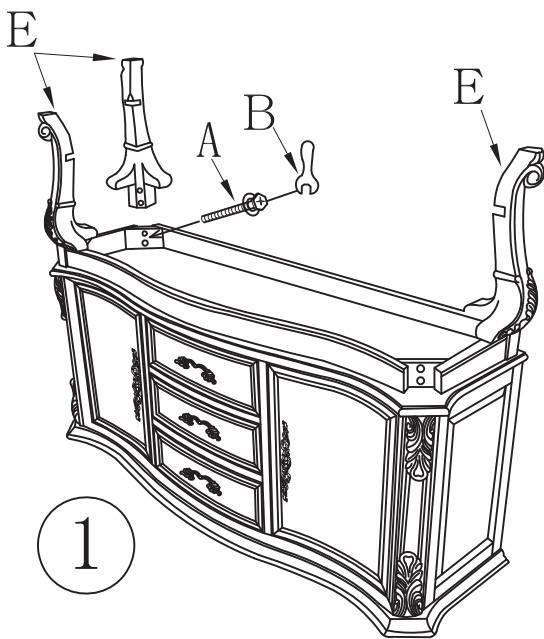

MADE IN CHINA
 HECHO EN CHINA

ANTI-TIPPING STRAP INSTRUCTION

Anti-tipping kit put on top drawer

HARDWARE (INCLUDED) :

TOOLS NEEDED (NOT INCLUDED) :



METAL BRACKETS 12*12*1*2PCS



DRYWALL SCREW \varnothing 5 X50 X1PC



STRAP 297 X5 X1PC



FLATHEAD SCREW \varnothing 5 X16 X1PC



DRILL & DRILL BIT

Note: Hardware included only compatible with standard drywalls.

STEP 1

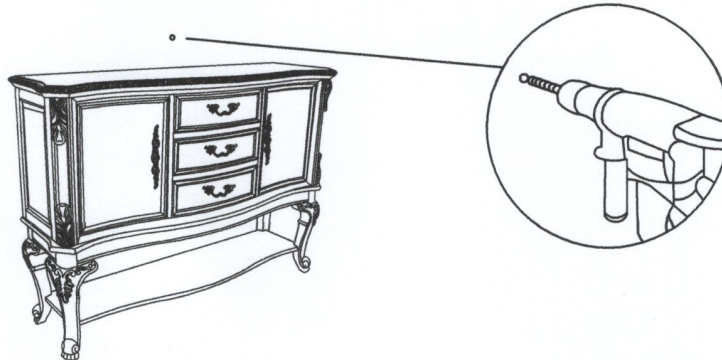

1. To drill a hole (about 1") on the wall.
2. To tap drywall anchor into the hole

STEP 2

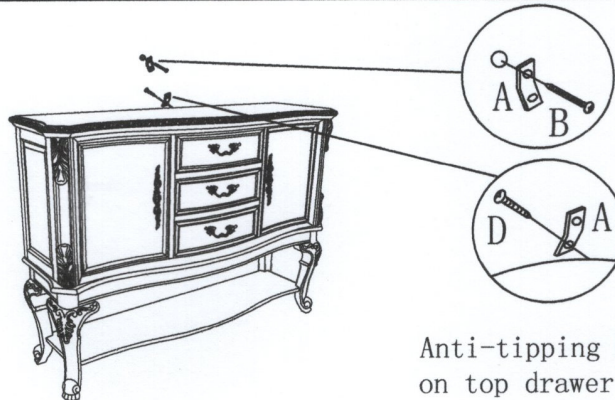

Anti-tipping kit put
on top drawer

1. To insert the screw into each bracket and hang one on drywall anchor.

STEP 3

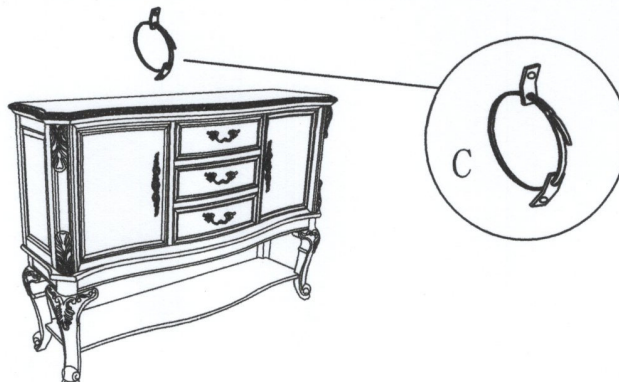

1. To tie the strap through bracket and pull it lightly till it steady.