

CROSLEY

FURNITURE

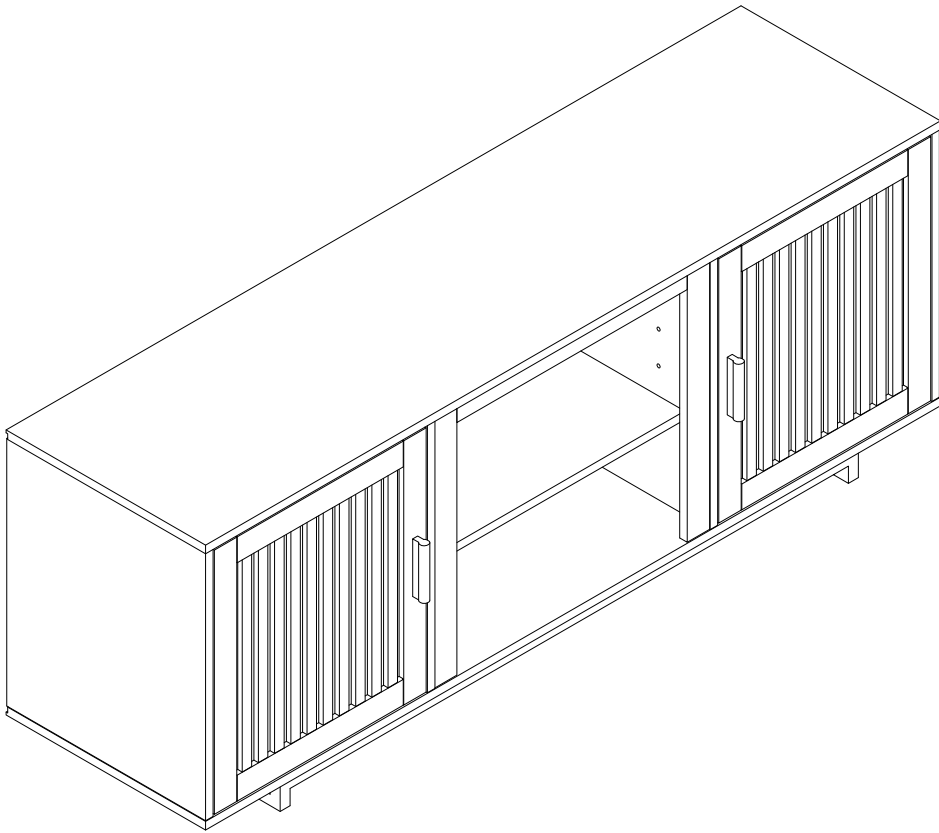





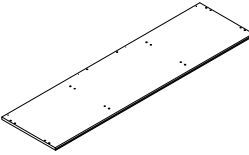
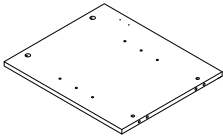
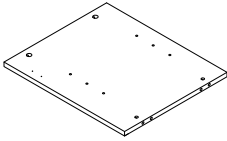
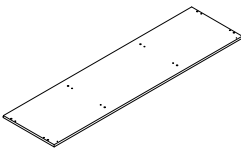
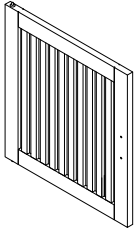
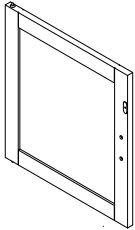
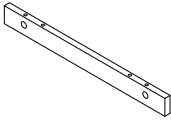
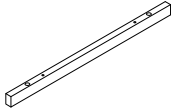
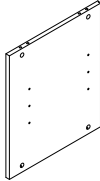
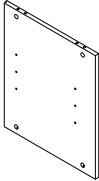
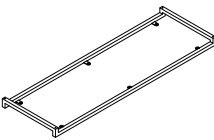
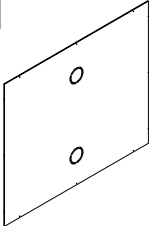
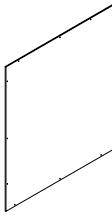
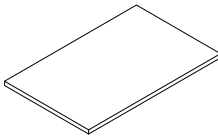
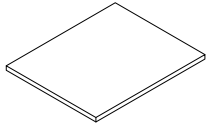

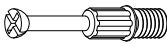
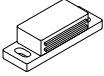

58" TV Stand
CF101458

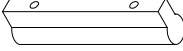

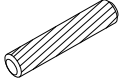
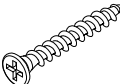
PART LIST

A 	B 	C 	D 	E 
Top Panel 1 PC	Left Partition Panel 1 PC	Right Partition Panel 1 PC	Bottom Panel 1 PC	Left Door 1 PC
F 	G 	H 	I 	J 
Right Door 1 PC	Vertical Rail 2 PCS	Top Rail 1 PC	Left Panel 1 PC	Right Panel 1 PC
K 	L 	M 	N 	O 
Bottom Frame 1 PC	Middle Back Panel 1 PC	Back Panel 2 PCS	Middle Adjustable Shelf 1 PC	Adjustable Shelf 2 PCS

HARDWARE LIST

 #1 Cam Bolt 20 PCS (Extra 1)	 #2 Magnet 2 PCS	 #3 Round Head Screw 4 PCS (Extra 1) Ø3*12mm	 #4 Handle 2 PCS	 #5 Round Head Bolt 4 PCS (Extra 1) Ø5/32"*3/4"
 #6 Cam Lock 20 PCS (Extra 2)	 #7 Wood Dowel 22 PCS (Extra 1) Ø8*30	 #8 Long Screw 2 PCS Ø4*1-1/4"	 #9 Adjustable Leveler 4 PCS	 #10 Bolt 6 PCS (Extra 1) 1/4"*12
 #11 Flat Washer 6 PCS (Extra 1) 1/4"*16	 #12 Allen Wrench 1 PC	 #13 Short Screw 30 PCS (Extra 1) Ø3*12mm	 #14 Shelf Holder 12 PCS (Extra 1)	

ADDITIONAL TOOLS (Not Provided)

Note: It is not recommended to use power tools during assembly.

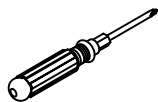

Phillips Head Screwdriver

Note: Wood dowels are intended for alignment. Additional clearance between wood dowel and pre-drilled hole is intentional for ease of assembly.

Step 1. Attach cam bolts (part #1) to panels (parts A, B, C & D) using phillips head screwdriver.

NOTE: Do not overtighten cam bolts. Stop tightening once threads on cam bolt are no longer visible.

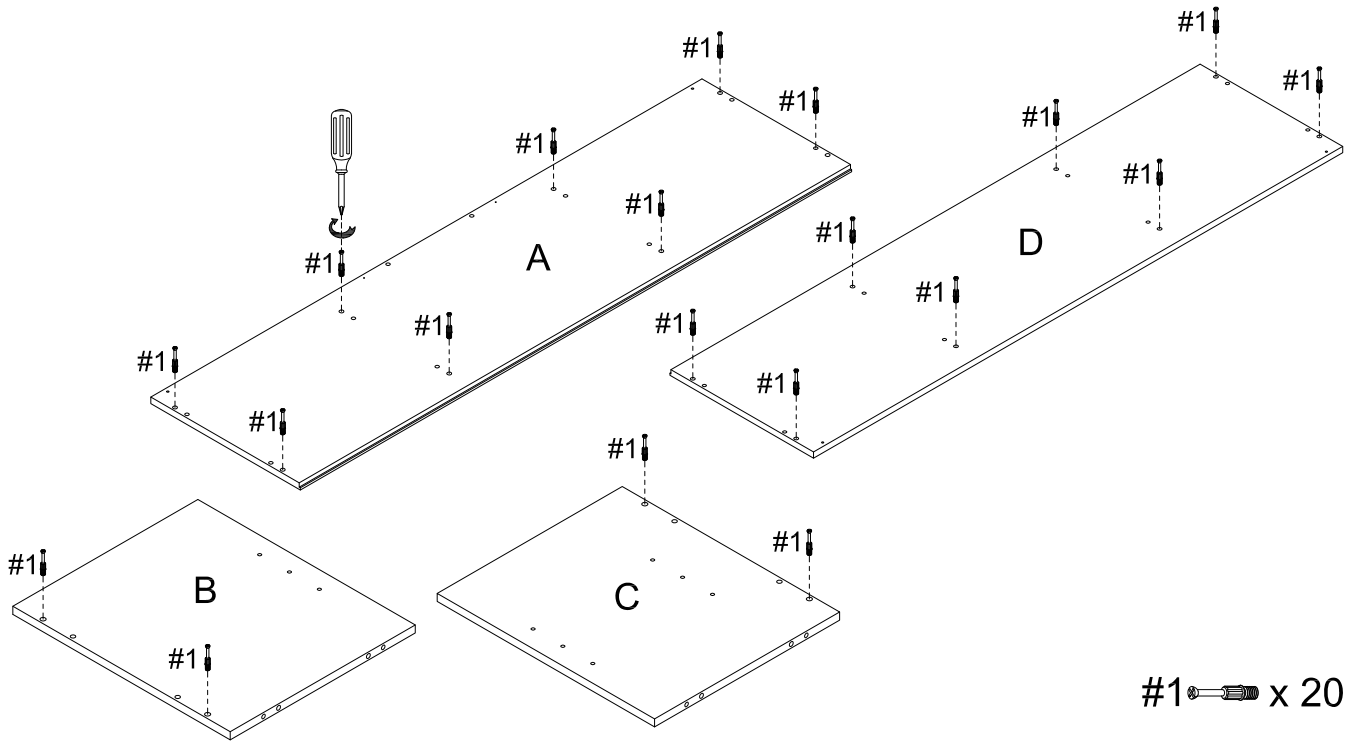

Step 2. Attach magnets (part #2) to partition panels (parts B & C) using round head screws (part #3) and phillips head screwdriver. Attach handles (part #4) to doors (parts E & F) using round head bolts (part #5) and phillips head screwdriver.

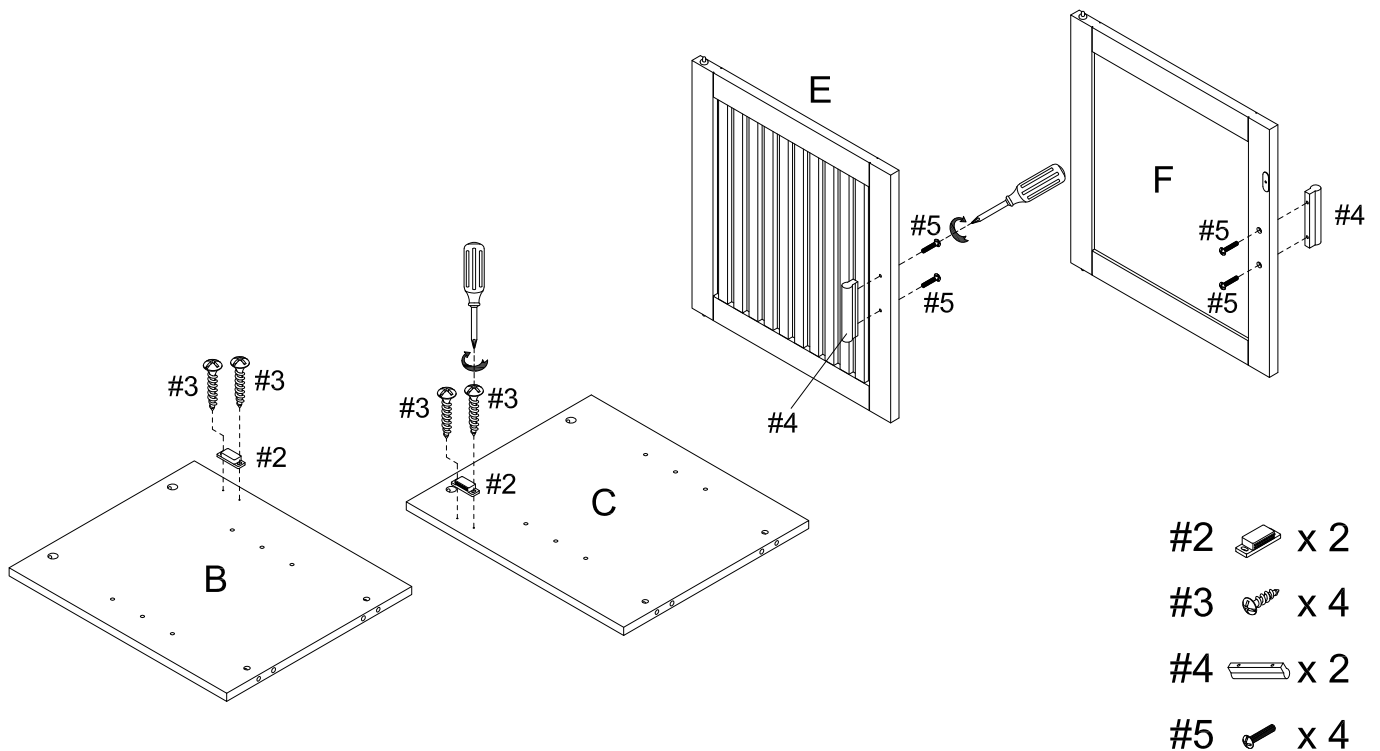

Step 3. Attach vertical rails (part G) to partition panels (parts B & C) using cam locks (part #6) and wood dowels (part #7). Attach top rail (part H) to top panel (part A) using wood dowels (part #7), long screws (part #8) and phillips head screwdriver.

NOTE: Cam locks must rotate a full 180° See pictured insert.

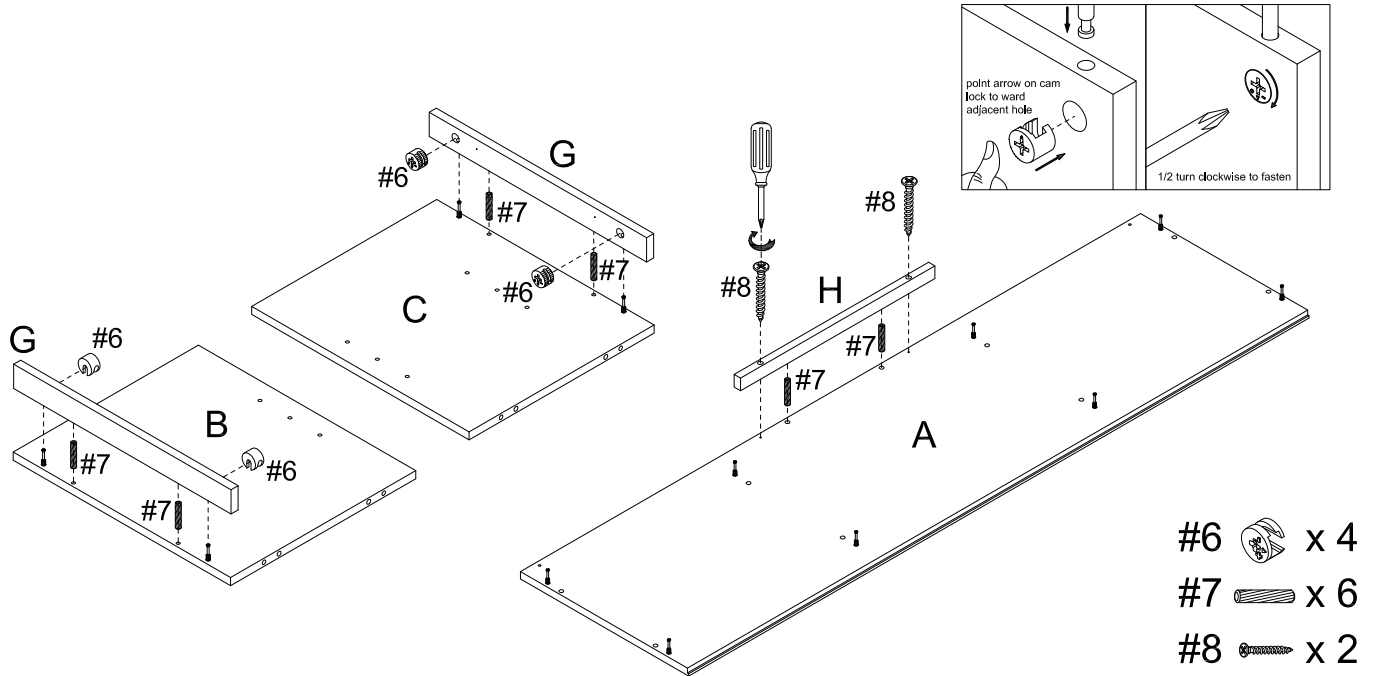

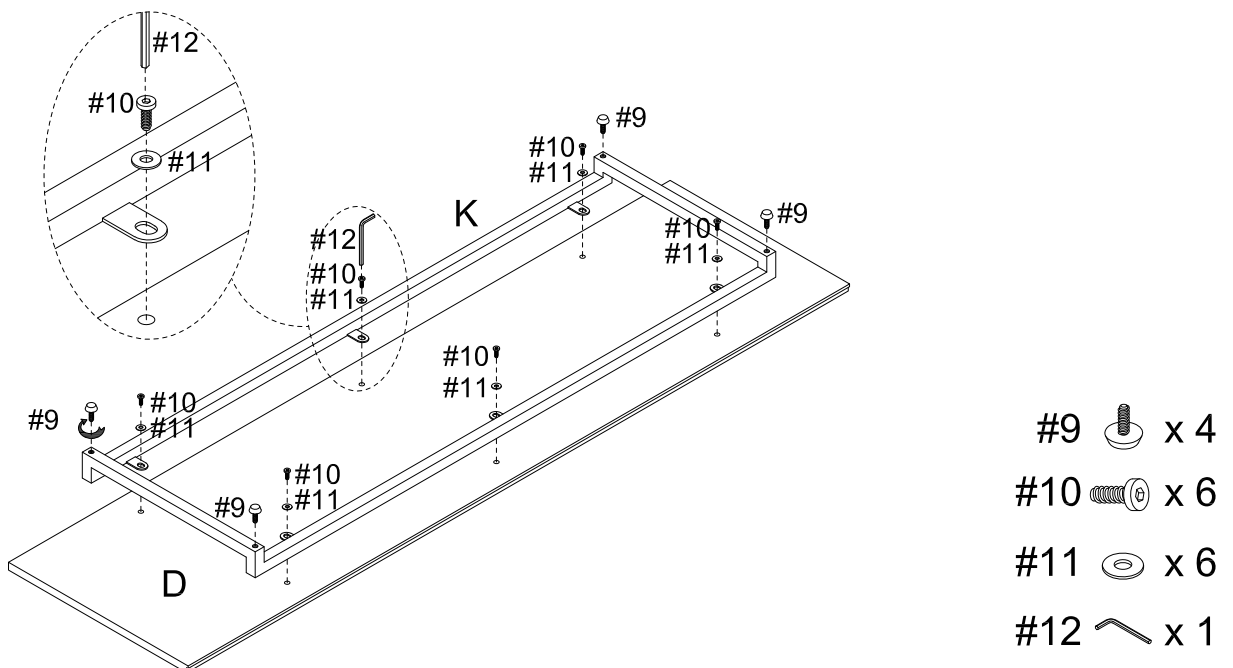

Step 4. Attach bottom frame (part K) to bottom panel (part D) using bolts (part #10), flat washers (part #11) and allen wrench (part #12). Attach adjustable levelers (part #9) to bottom frame (part K).

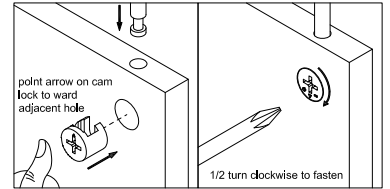
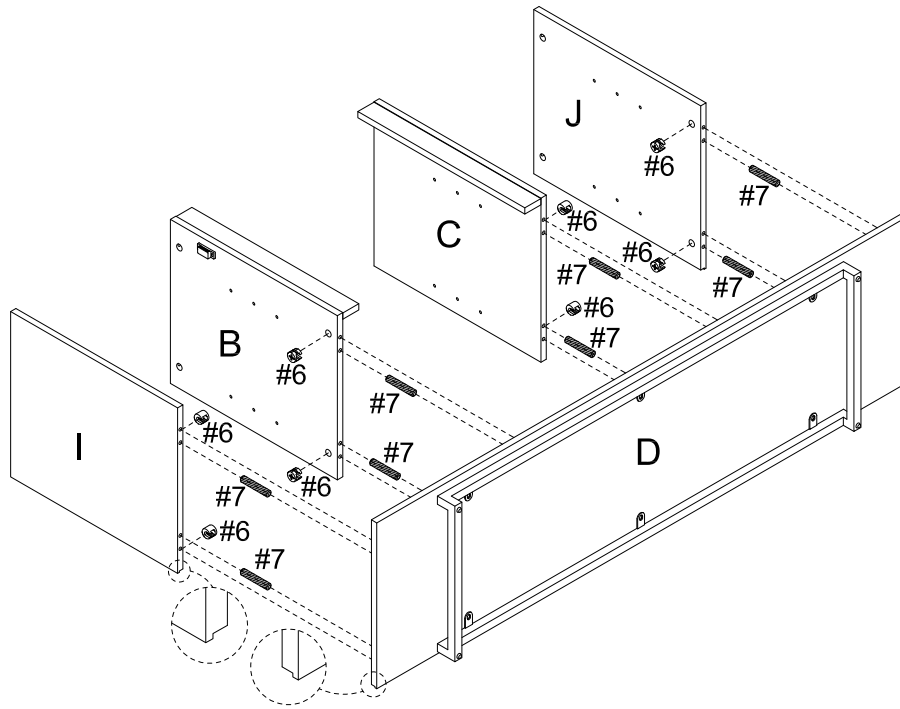

Step 5. Attach partition panels (parts B & C) to bottom panel (part D) using cam locks (part #6) and wood dowels (part #7). Attach left panel (part I) and right panel (part J) to bottom panel (part D) using cam locks (part #6) and wood dowels (part #7).

NOTE: Cam locks must rotate a full 180° See pictured insert.





#6  x 8
 #7  x 8

Step 6. Carefully turn unit upright. Attach top panel (part A) to assembled unit (parts B, C, I & J) using cam locks (part #6) and wood dowels (part #7).

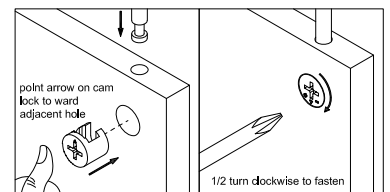
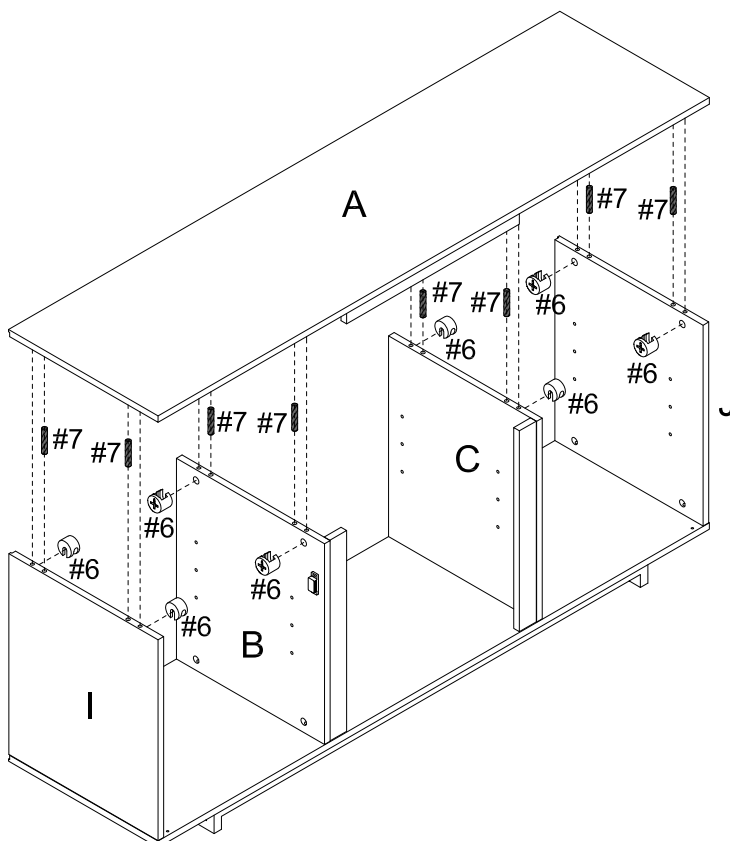
NOTE: Cam locks must rotate a full 180° See pictured insert.



#6  x 8
 #7  x 8

Step 7. Attach back panels (parts L & M) to top panel (part A), partition panels (parts B & C), bottom panel (part D), left panel (part I) and right panel (part J) using short screws (part #13) and phillips head screwdriver.

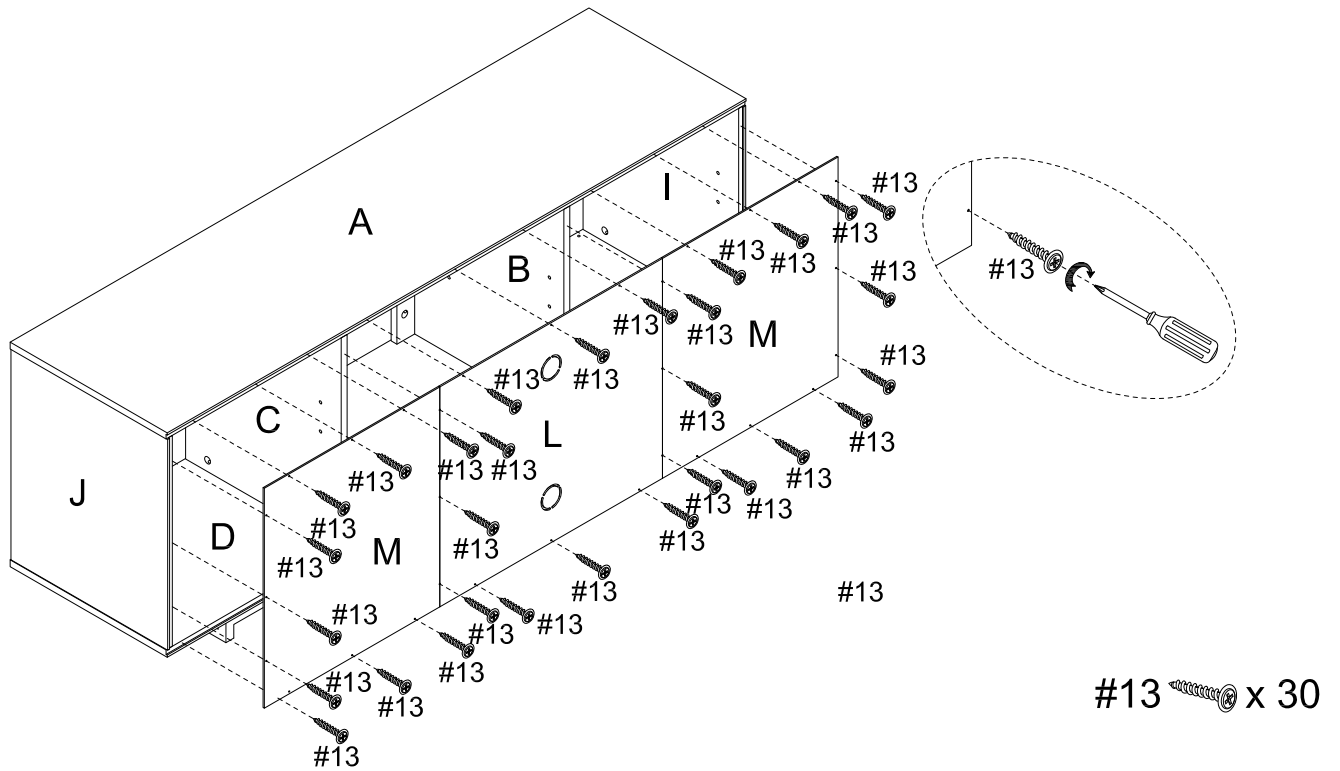

Step 8. Place shelf holders (part #14) into desired position and then slide adjustable shelves (parts N & O) into place.

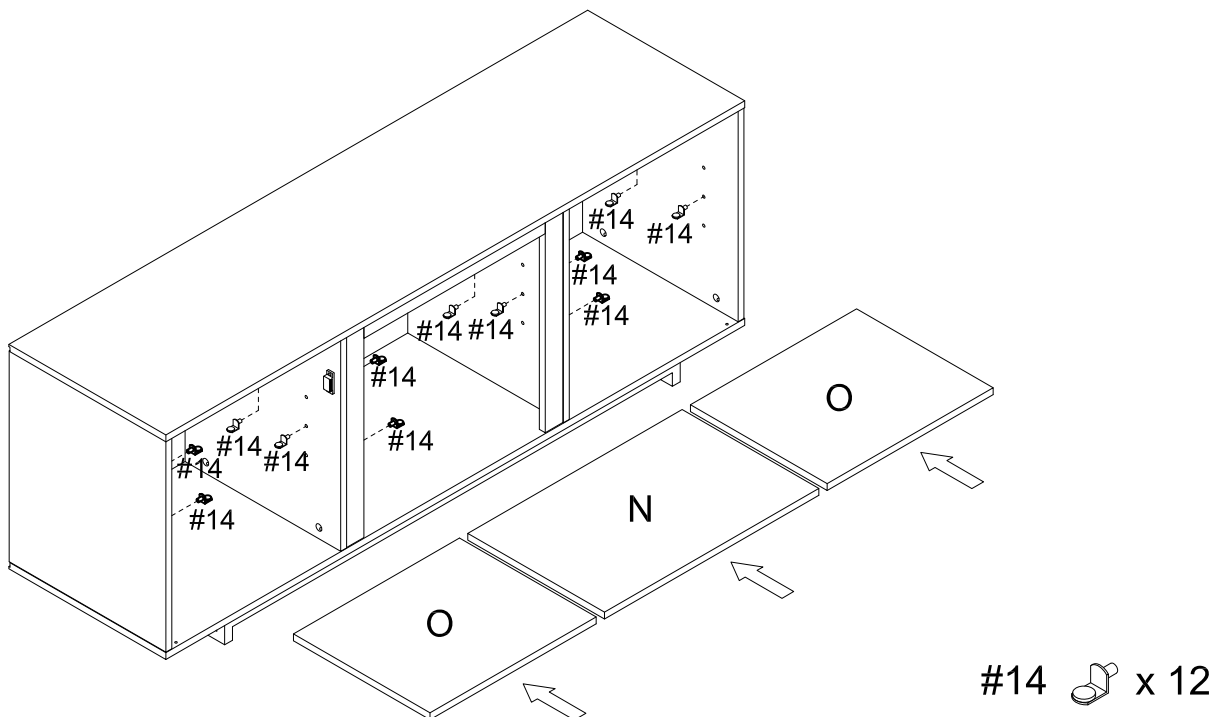

Step 9. Attach doors (parts E & F) by placing bottom pin hinge (pre-installed in door) in the pre-drilled hole of bottom panel (part D). Then depress the top spring-loaded pin hinge so it can be placed in the pre-drilled hole of top panel (part A). If you would like to add an electric fireplace (*Not Included), please follow step 10.

NOTE: Be sure top and bottom pin hinges are fully extended to secure doors in place.

NOTE: It is important to adjust levelers once fully assembled and upright. Extend adjustable leveler until it's firmly in contact with the floor. If relocating, adjust leveler as needed until it's firmly in contact with the floor in new location.

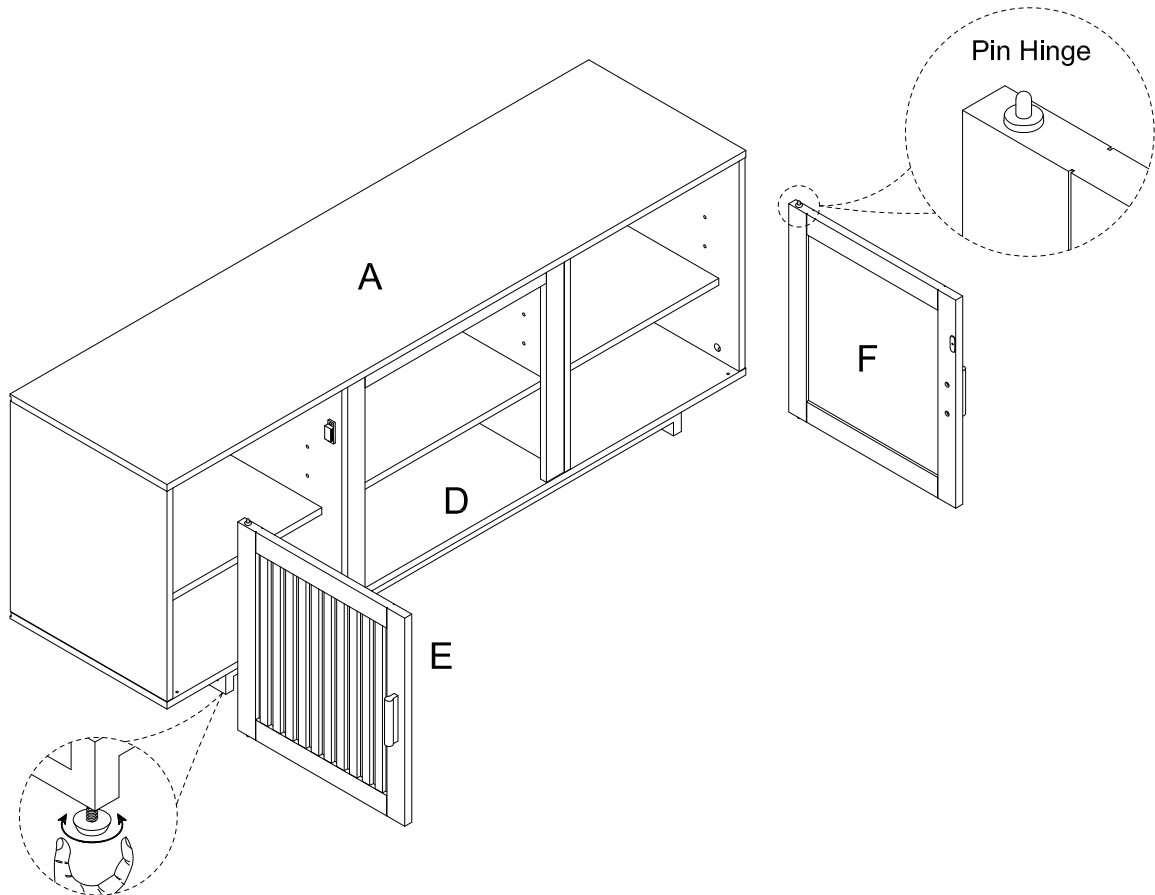

Step 10. Fireplace Assembly: Remove middle adjustable shelf (part N) and middle back panel (part L). Install electric fireplace (*Not Included) into the unit following the assembly instructions of the electric fireplace.

