

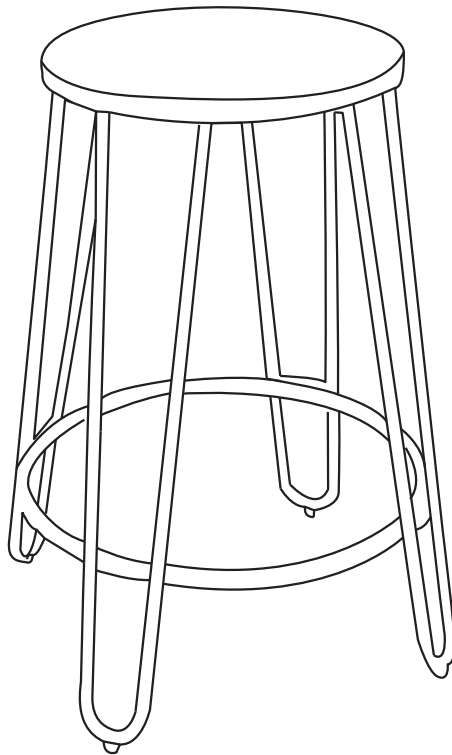







Stool
CF8022

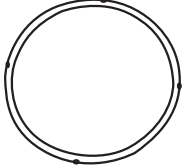

PART LIST

<div data-bbox="172 197 220 246" style="border: 1px solid black; padding: 2px;">A</div> 	<div data-bbox="454 197 502 246" style="border: 1px solid black; padding: 2px;">B</div> 	<div data-bbox="734 197 782 246" style="border: 1px solid black; padding: 2px;">C</div> 
<p style="text-align: center;">Seat 1 PC</p>	<p style="text-align: center;">Footrest 1 PC</p>	<p style="text-align: center;">Leg 4 PCS</p>

HARDWARE LIST

<div data-bbox="172 622 220 672" style="border: 1px solid black; padding: 2px;">#1</div>  <p style="text-align: center;">M6*16mm</p>	<div data-bbox="454 622 502 672" style="border: 1px solid black; padding: 2px;">#2</div>  <p style="text-align: center;">M6</p>	<div data-bbox="734 622 782 672" style="border: 1px solid black; padding: 2px;">#3</div>  <p style="text-align: center;">M6</p>
<p style="text-align: center;">Bolt 12 PCS (Extra 1)</p>	<p style="text-align: center;">Flat Washer 8 PCS (Extra 1)</p>	<p style="text-align: center;">Allen Wrench 1 PC</p>

Step 1. Carefully lay seat (part A) upside down on a flat, soft surface, such as carpet. Attach legs (part C) to seat (part A) using bolts (part #1), flat washers (part #2) and allen wrench (part #3).

Note: Please do not fully tighten bolts at this time.

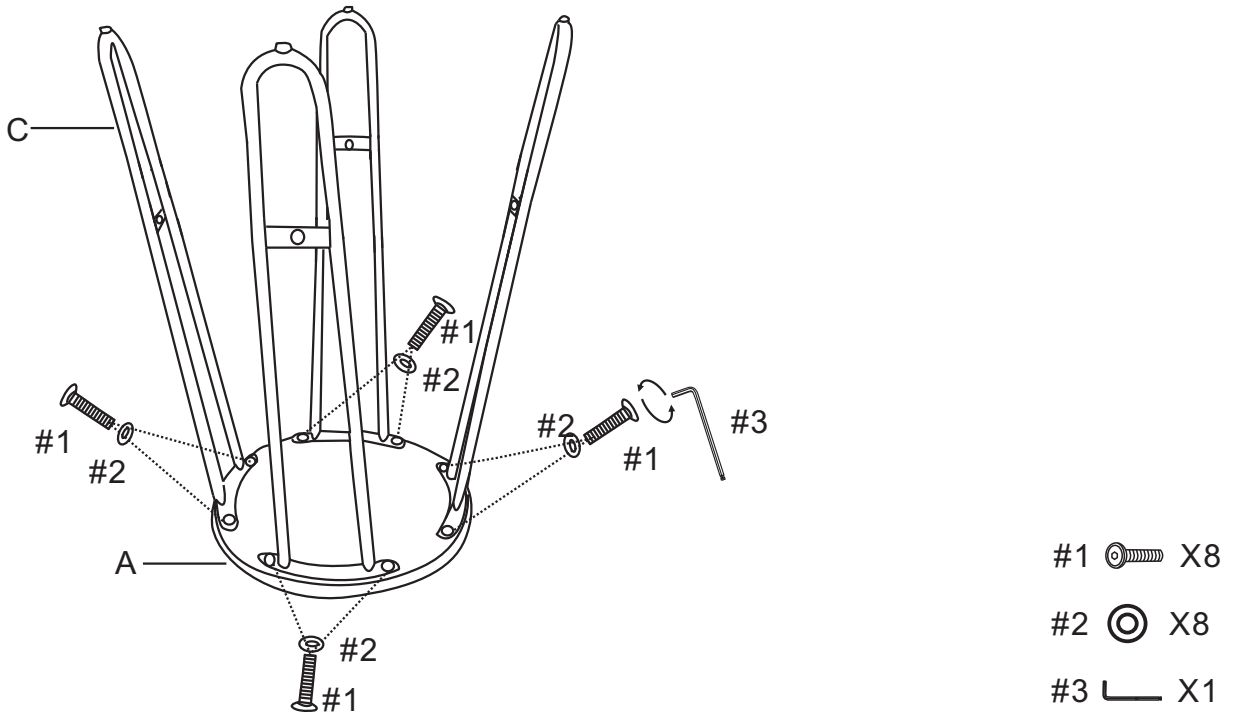

Step 2. Attach footrest (part B) to legs (part C) using bolts (part #1) and allen wrench (part #3).

Note: Please fully tighten all bolts at this time.

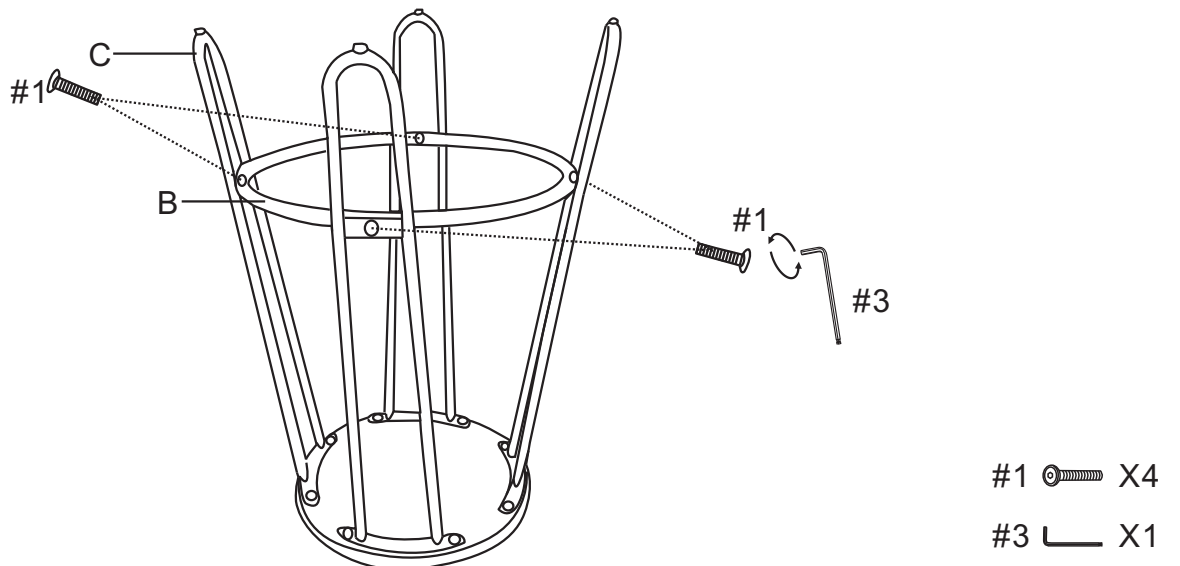

Step 3. Carefully turn unit upright.

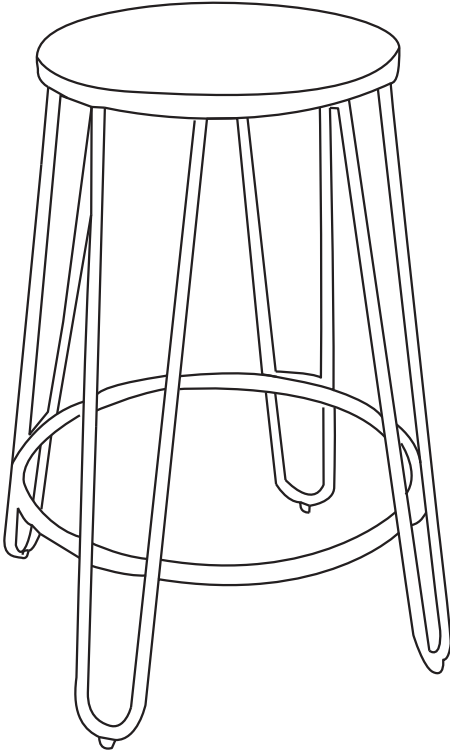

Caution:
Do not stand on the stool under any circumstance.