

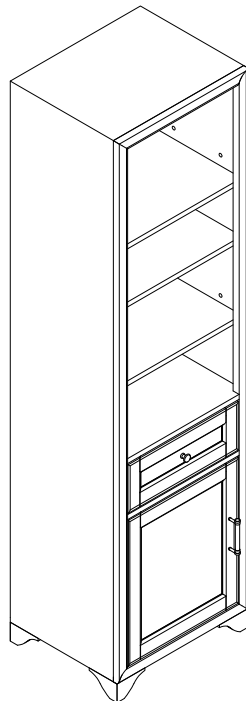

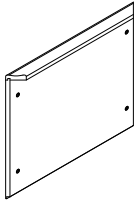

Linen Valet  
CF7011

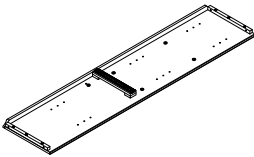
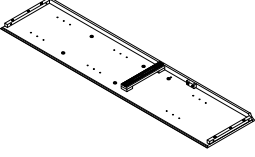
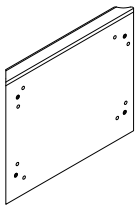
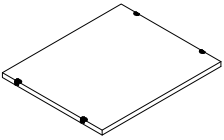
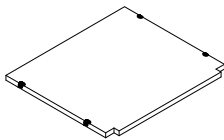
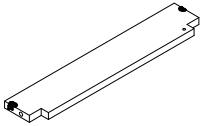
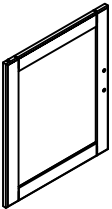
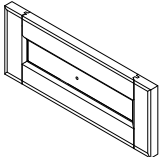
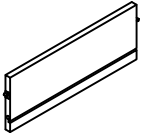
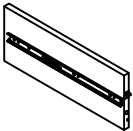
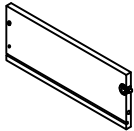
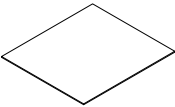

# PART LIST

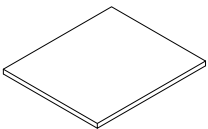
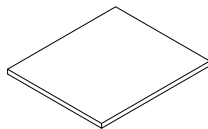
<b>A</b> 	<b>B</b> 	<b>C</b> 	<b>D</b> 	<b>E</b> 
Top Panel 1 PC	Left Panel 1 PC	Right Panel 1 PC	Bottom Panel 1 PC	Upper Fixed Shelf 1 PC
<b>F</b> 	<b>G</b> 	<b>H</b> 	<b>I</b> 	<b>J</b> 
Lower Fixed Shelf 1 PC	Rail 1 PC	Door Panel 1 PC	Drawer Front Panel 1 PC	Drawer Back Panel 1 PC
<b>K</b> 	<b>L</b> 	<b>M</b> 	<b>N</b> 	<b>O</b> 
Drawer Left Panel 1 PC	Drawer Right Panel 1 PC	Drawer Bottom Panel 1 PC	Back Panel 1 PC	Leg 4 PCS
<b>P</b> 	<b>Q</b> 			
Upper Adjustable Shelf 2 PCS	Lower Adjustable Shelf 1 PC			

# HARDWARE LIST

 Ø8*30mm	 Ø6*30mm		 12*Ø3*D6mm	
Large Wood Dowel 10 PCS (Extra 1)	Small Wood Dowel 4 PCS (Extra 1)	Magnet 1 PC	Round Head Screw 2 PCS (Extra 1)	Handle 1 PC
	 1/2"*Ø5/32"*D9mm	 3/4"*Ø5/32"*D9mm	 1-1/4"*Ø1/4"*D11mm	
Knob 1 PC	Short Round Head Bolt 1 PC (Extra 1)	Long Round Head Bolt 2 PCS (Extra 1)	Bolt 12 PCS (Extra 1)	Flat Washer 4 PCS (Extra 1)
				
Spring Washer 4 PCS (Extra 1)	Shelf Holder 12 PCS (Extra 1)	Screw 20 PCS (Extra 1)	Allen Wrench 1 PC	Safety Strap Kit 1 PC

## ADDITIONAL TOOLS (Not Provided)

Note: It is not recommended to use power tools during assembly.

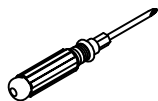

Phillips Head Screwdriver

Note: Wood dowels are intended for alignment. Additional clearance between wood dowel and pre-drilled hole is intentional for ease of assembly.

Please do not use tools to assemble this unit unless specifically indicated.

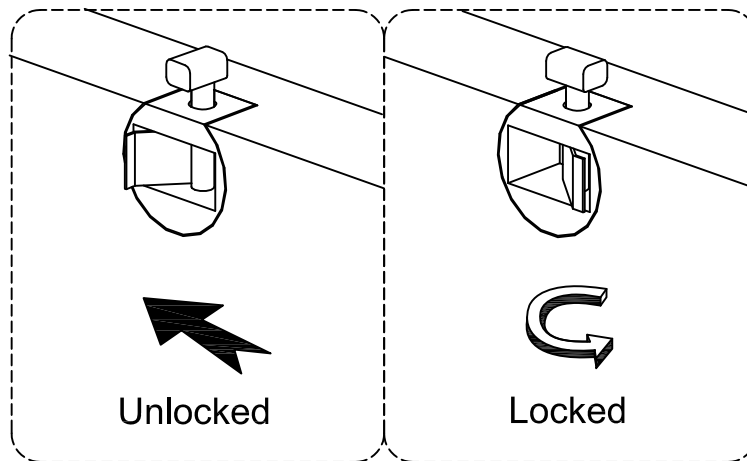

Reference the images above any time the instructions state "lock the hardware".  
 Note: Be sure to check all hardware is locked when completed.

Step 1. There are two installation options for magnet (part #3) based on door panel (part H) installation. Attach magnet (part #3) to rail (part G) using round head screws (part #4) and phillips head screwdriver. Attach knob (part #6) to drawer front panel (part I) using short round head bolt (part #7) and phillips head screwdriver. Attach handle (part #5) to door panel (part H) using long round head bolts (part #8) and phillips head screwdriver.

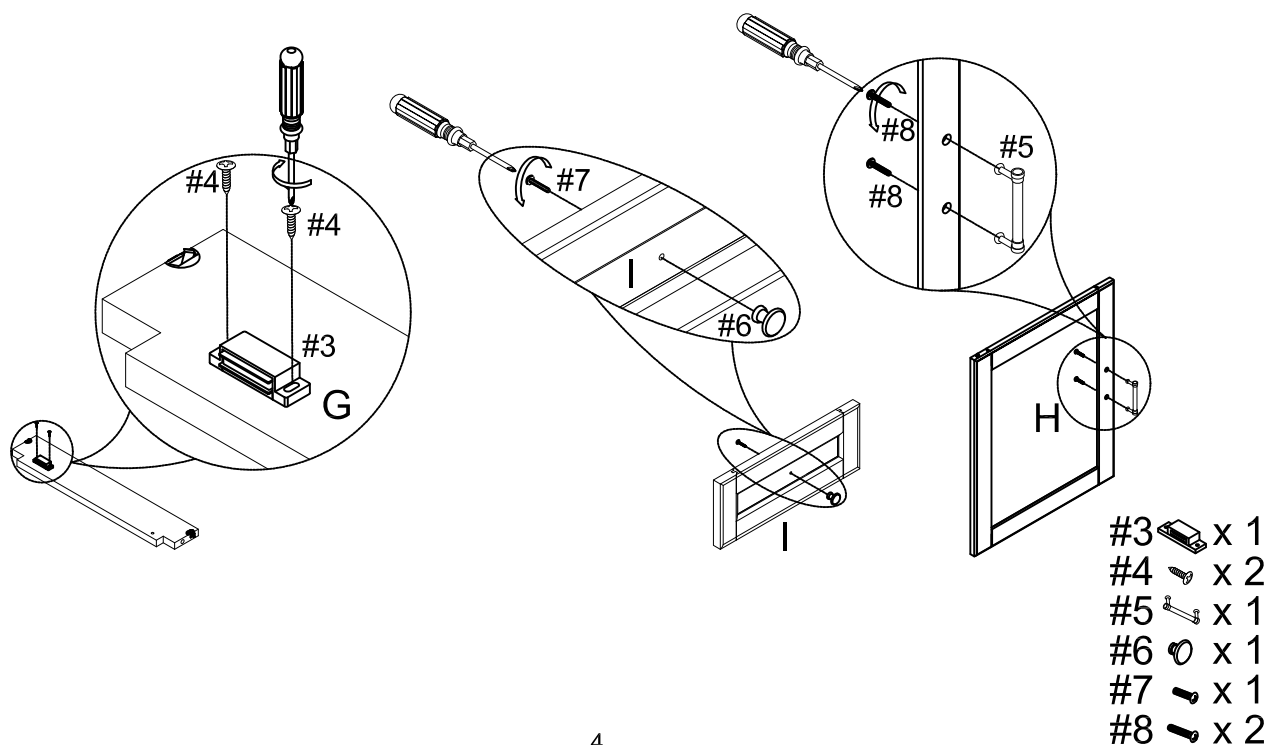

Step 2. Attach drawer left panel (part K) and drawer right panel (part L) to drawer back panel (part J) using small wood dowels (part #2) and lock the hardware. Slide drawer bottom panel (part M) into grooves of assembled unit (parts J, K & L). Attach drawer front panel (part I) to assembled unit (parts K, L & M) using small wood dowels (part #2) and lock the hardware.

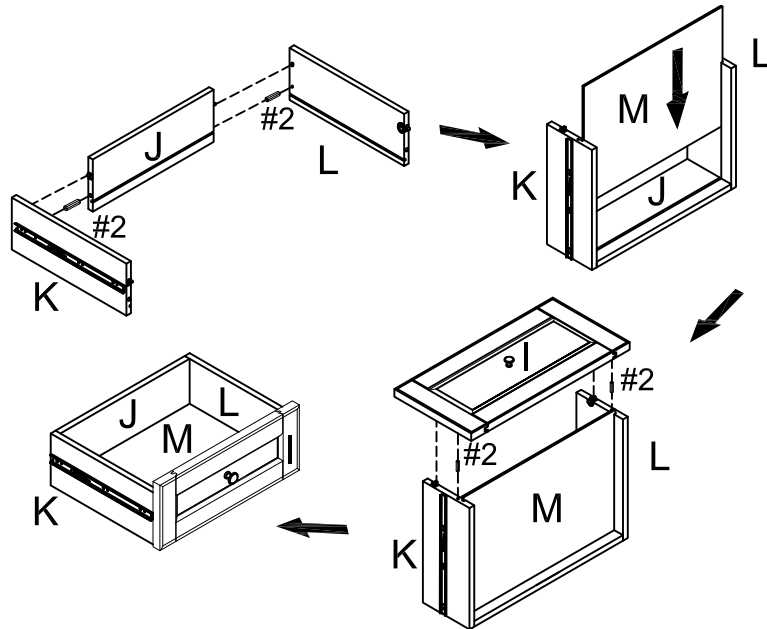

#2  x 4

Step 3. Lay right panel (part C) upside down on a soft flat surface, such as carpet. Attach upper fixed shelf (part E), lower fixed shelf (part F) and rail (part G) to right panel (part C) using large wood dowel (part #1) and lock the hardware.

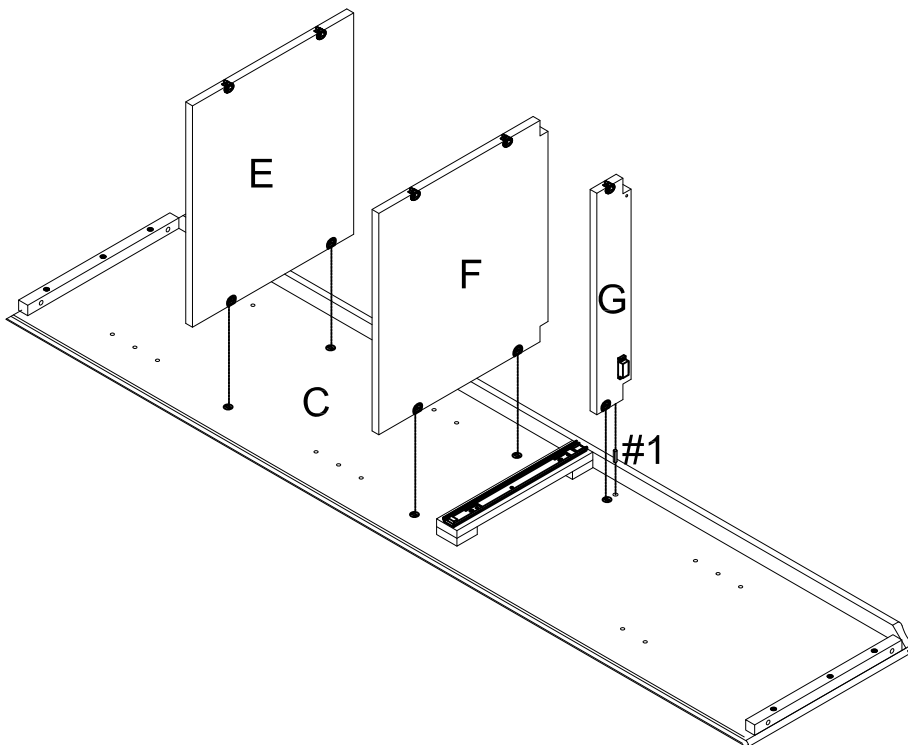

#1  x 1

Step 4. Attach left panel (part B) to upper fixed shelf (part E), lower fixed shelf (part F) and rail (part G) using large wood dowel (part #1) and lock the hardware.

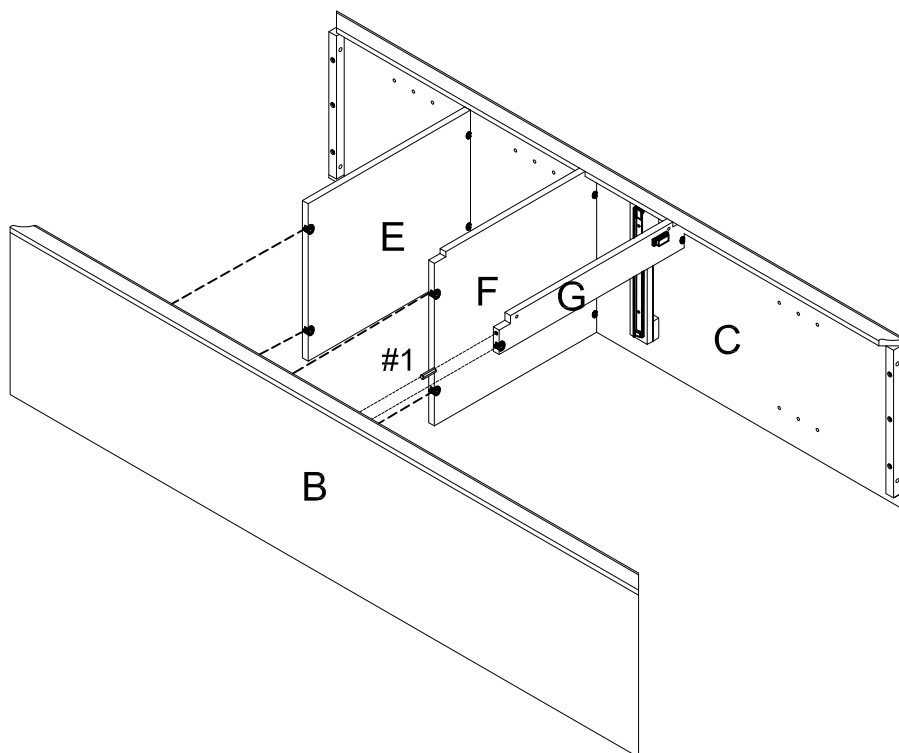

#1  x 1

Step 5. Attach top panel (part A) and bottom panel (part D) to left panel (part B) and right panel (part C) using bolts (part #9) and allen wrench (part #14).

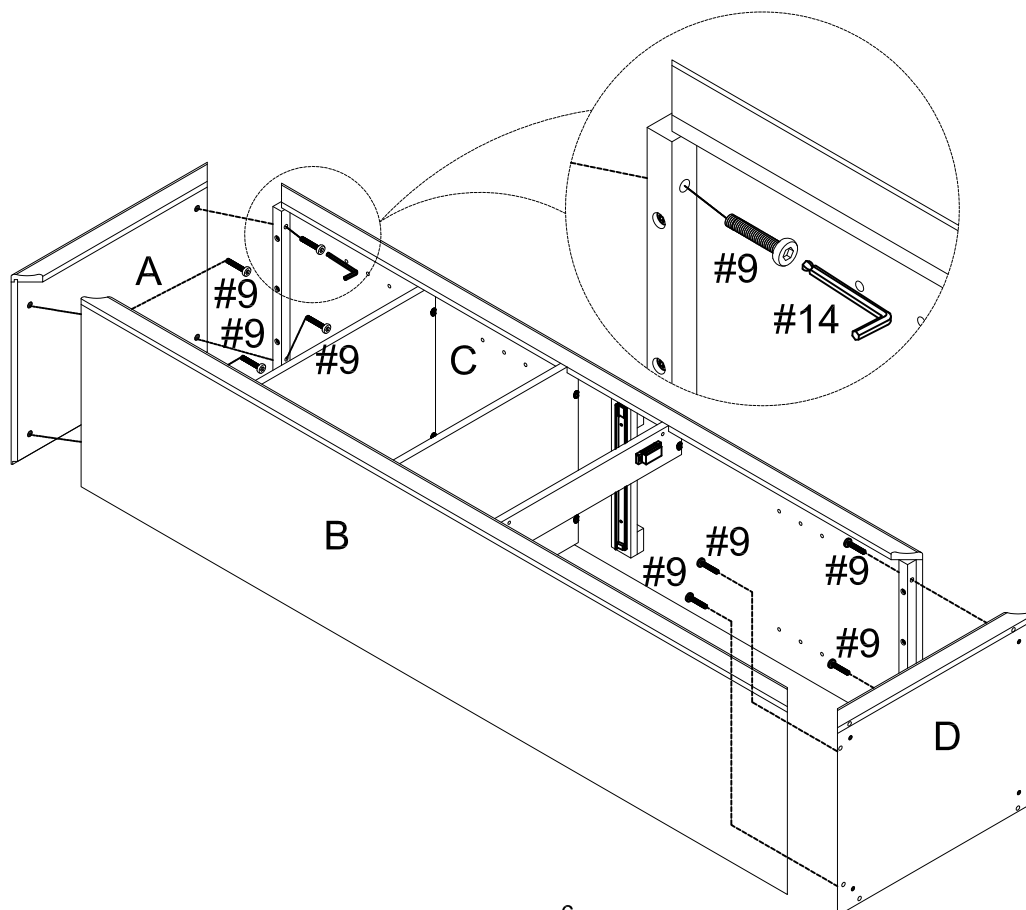

#9  x 8  
 #14  x 1

Step 6. Attach legs (part O) to bottom panel (part D) using large wood dowels (part #1), flat washers (part #10), spring washers (part #11), bolts (part #9) and allen wrench (part #14).

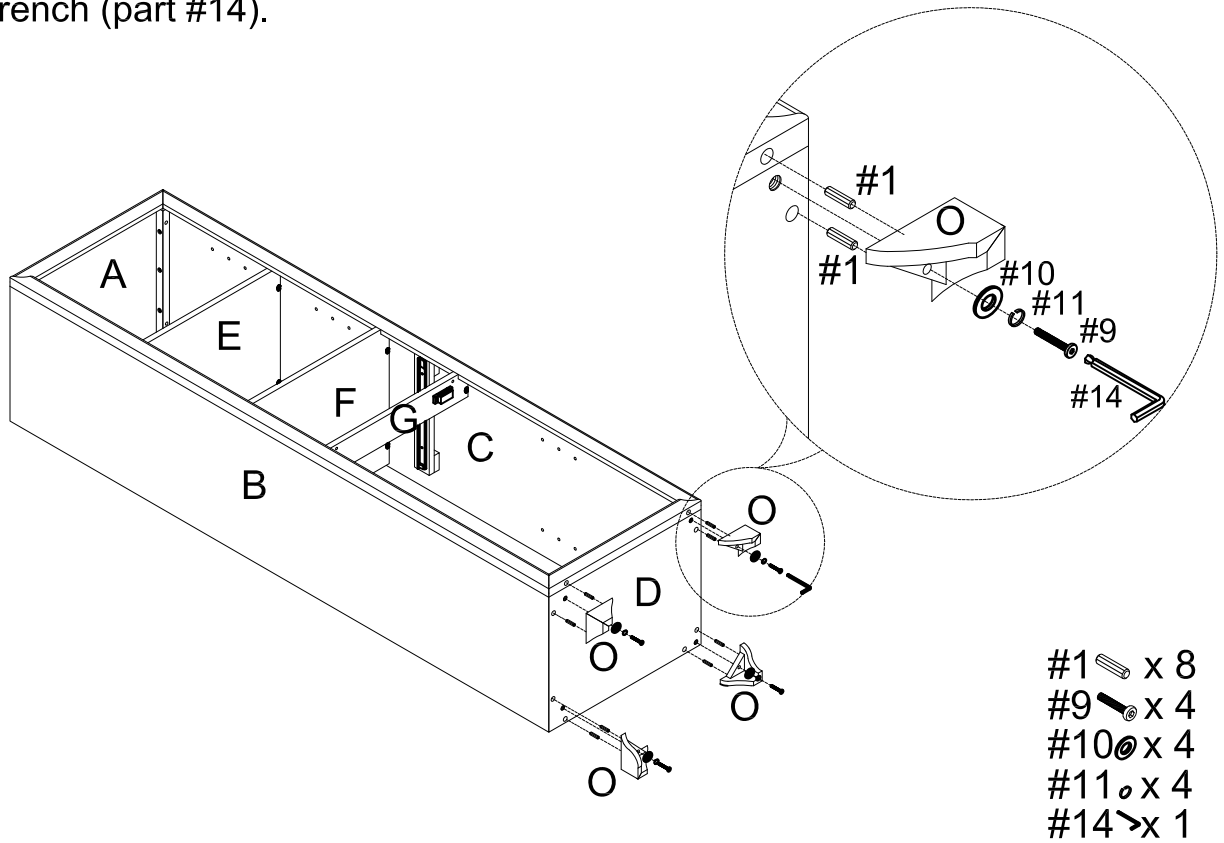

Step 7. Carefully turn the unit upright. Attach back panel (part N) to assembled unit (parts A, B, C, D, E & F) using screws (part #13) and phillips head screwdriver.

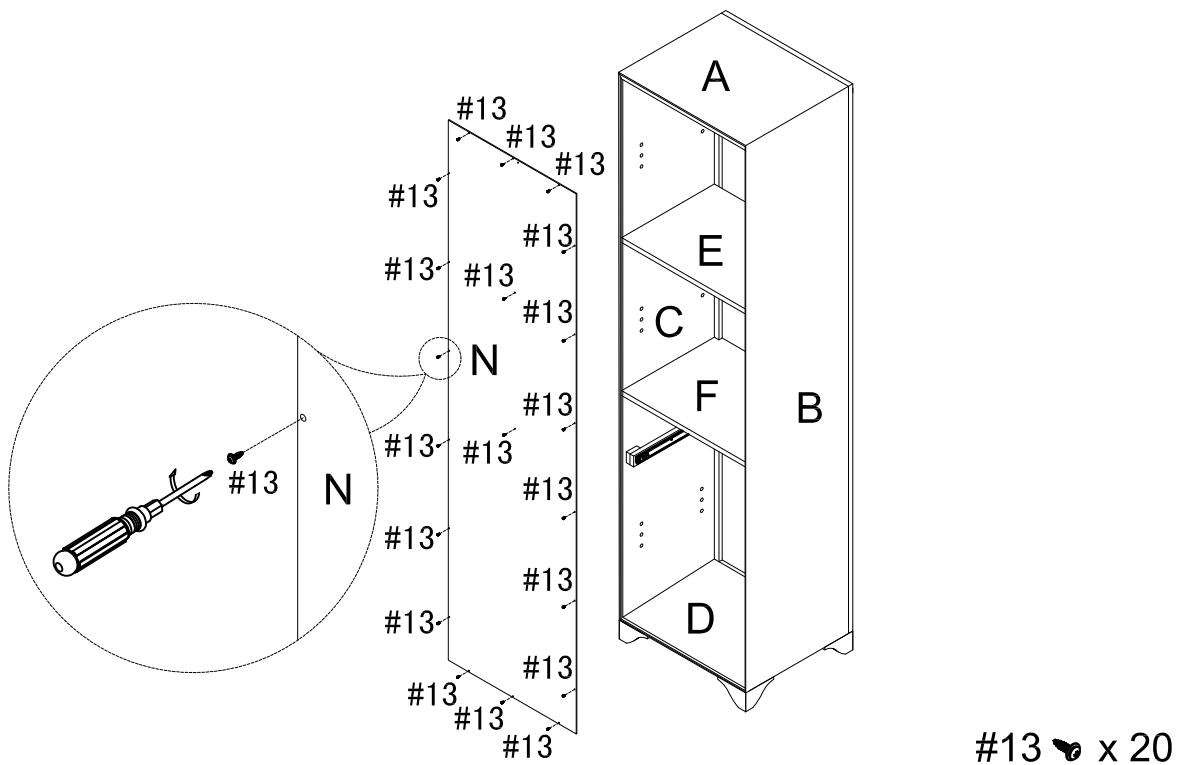

Step 8. Slide assembled drawer into place. There are two installation options for door panel (part H). Attach door panel (part H) by placing bottom pin hinge (pre-installed in door) in the pre-drilled hole of bottom panel (part D). Then depress the top spring-loaded pin hinge so it can be placed in the pre-drilled hole of rail (part G).

NOTE: Be sure top and bottom pin hinges are fully extended to secure door in place.

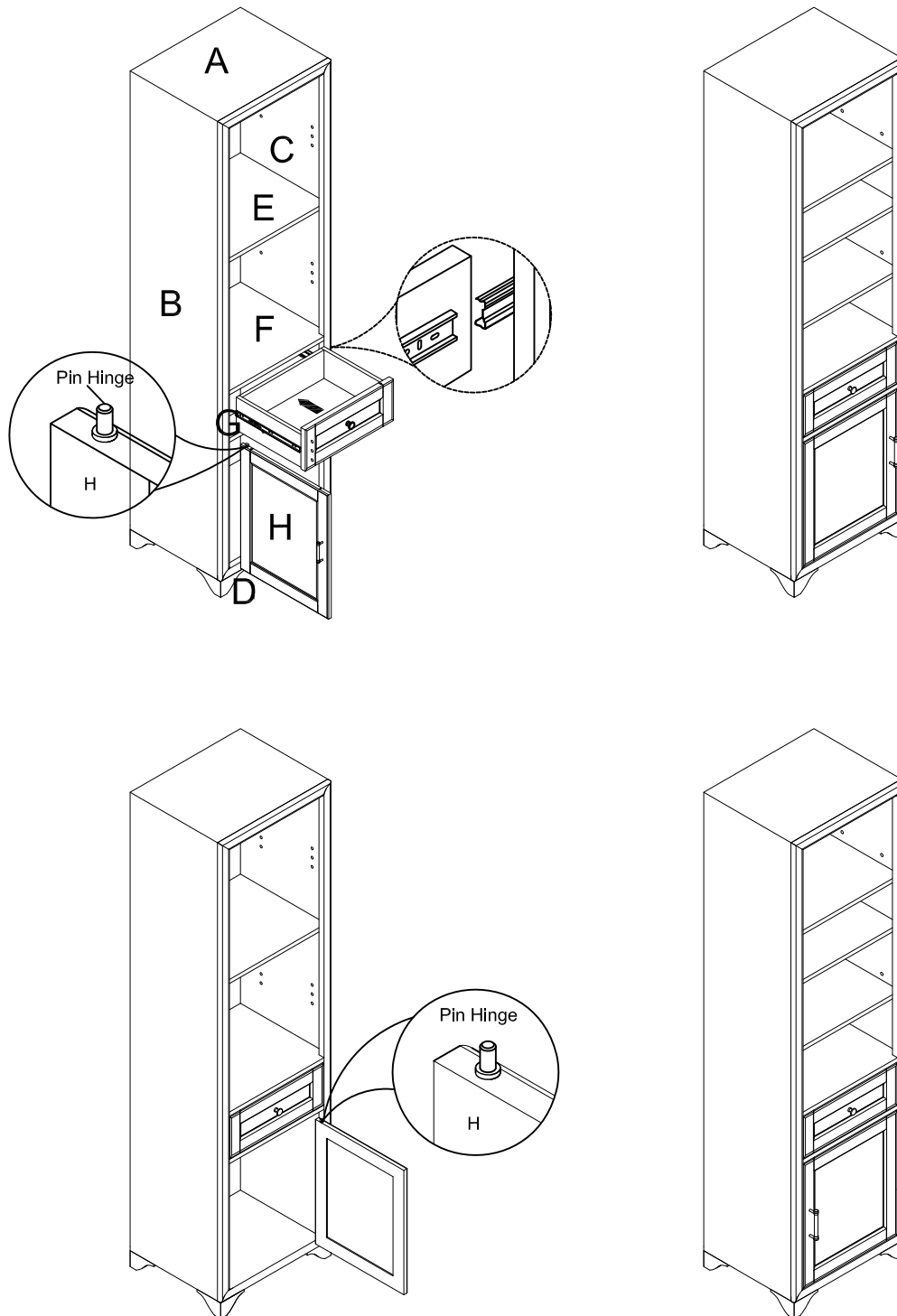





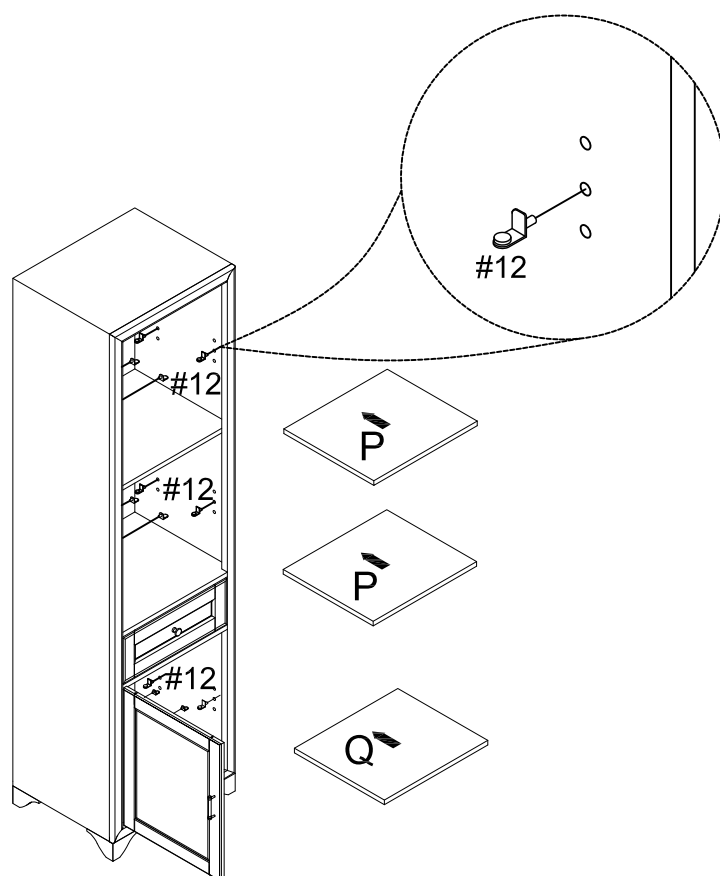

Step 9. Place shelf holders (part #12) into desired position and then slide upper adjustable shelves (part P) and lower adjustable shelf (part Q) into place.

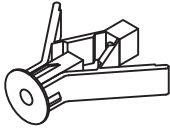

#12  x 12

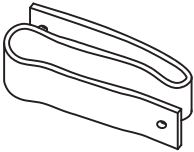
#15	A	B	C	D	E
			 D8*3/4"	 D8*1-1/2"	
Safety Strap Kit 1 PC	Wall Anchor 1 PC	Washer 2 PCS	Short Screw 1 PC	Long Screw 1 PC	Safety Wall Strap 1 PC

## SAFETY WALL STRAP INSTALLATION

Note: It is highly recommended to install this safety strap kit to prevent tipping, damage and/or injury.

1. Insert short screw (C) through washer (B) and safety wall strap (E) and attach to back panel (part N) using phillips head screwdriver.
2. Drill a 11/32" hole where you want to secure the unit. The drilled hole will be at the same height as the hole in back panel (part N) where the safety wall strap (E) is attached. Tap wall anchor (A) into the hole.
3. Insert long screw (D) through washer (B) and safety wall strap (E) into wall anchor (A) using phillips head screwdriver.

Note: This item is not intended for clothing storage use.

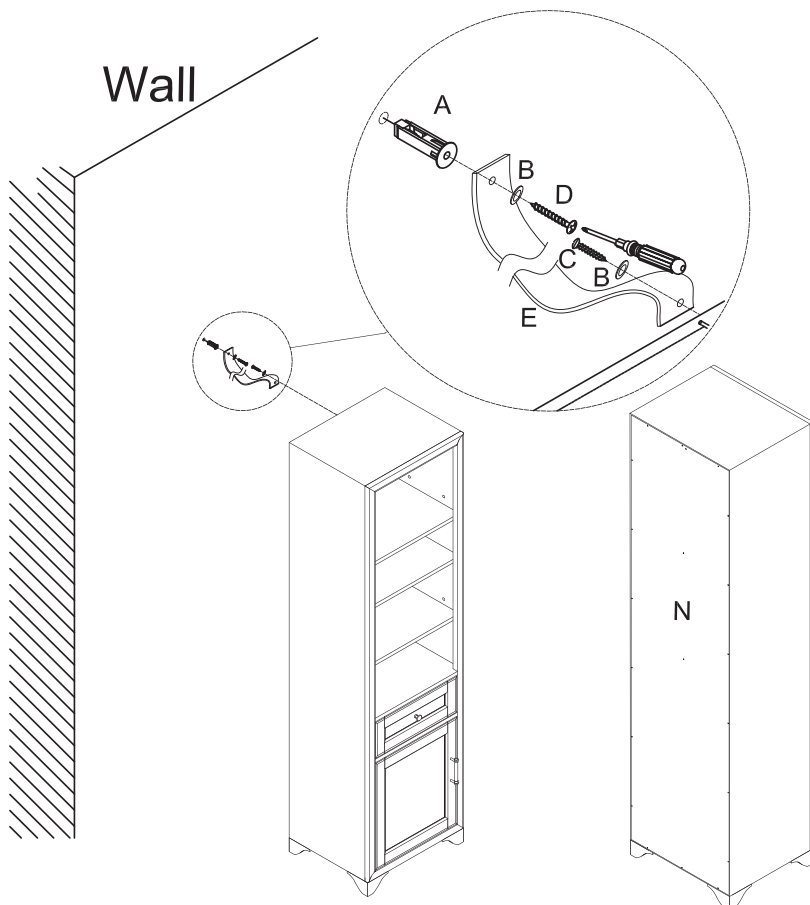

**▲ WARNING**

**Children have died from furniture tipover. To reduce the risk of furniture tipover:**

- ALWAYS install tipover restraint provided.
- NEVER put a TV on this product.
- NEVER allow children to stand, climb or hang on drawers, doors, or shelves.
- NEVER open more than one drawer at a time.
- Place heaviest items in the lowest drawers.

*This is a permanent label. Do not remove!*