

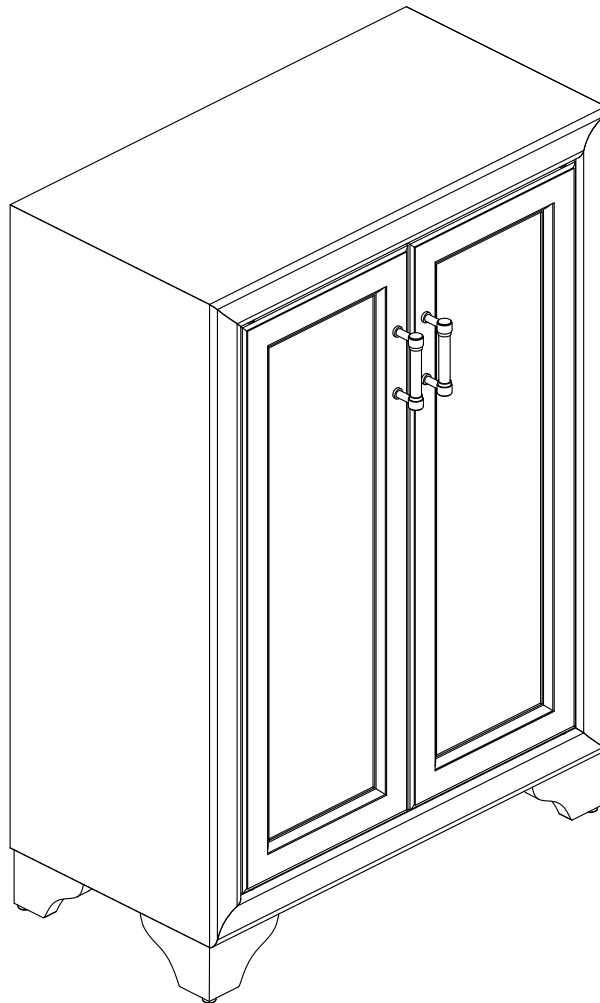

CROSLEY

FURNITURE





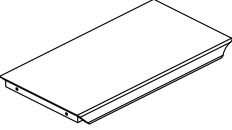
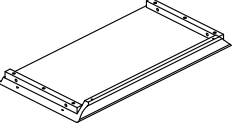
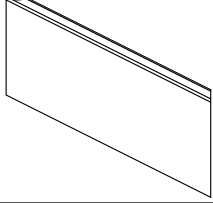
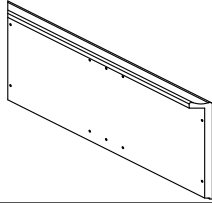
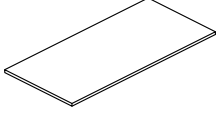
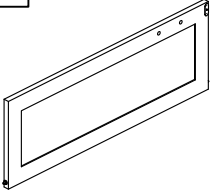
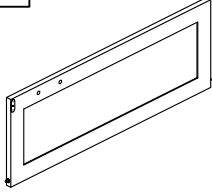
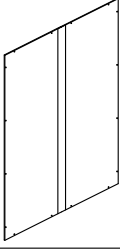



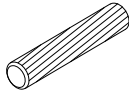
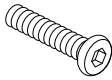
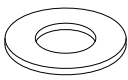

Accent Cabinet
CF3110

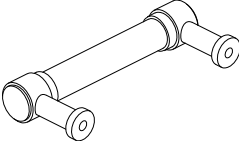

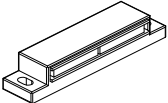
PART LIST

<p>A</p> 	<p>B</p> 	<p>C</p> 	<p>D</p> 	<p>E</p> 
<p>Top Panel 1 PC</p>	<p>Bottom Panel 1 PC</p>	<p>Left Panel 1 PC</p>	<p>Right Panel 1 PC</p>	<p>Adjustable Shelf 1 PC</p>
<p>F</p> 	<p>G</p> 	<p>H</p> 	<p>I</p> 	
<p>Left Door Panel 1 PC</p>	<p>Right Door Panel 1 PC</p>	<p>Back Panel 1 PC</p>	<p>Leg 4 PCS</p>	

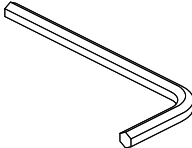
HARDWARE LIST

<p>#1</p> 	<p>#2</p>  <p>Ø1/4"*1-1/4"</p>	<p>#3</p> 	<p>#4</p> 	<p>#5</p>  <p>Ø3*12mm</p>
<p>Wood Dowel 8 PCS (Extra 1)</p>	<p>Bolt 12 PCS (Extra 1)</p>	<p>Flat Washer 4 PCS (Extra 1)</p>	<p>Spring Washer 4 PCS (Extra 1)</p>	<p>Round Head Screw 2 PCS (Extra 1)</p>
<p>#6</p> 	<p>#7</p>  <p>Ø5/32"*5/8"</p>	<p>#8</p> 	<p>#9</p> 	<p>#10</p>  <p>Ø3*12mm</p>
<p>Handle 2 PCS</p>	<p>Round Head Bolt 4 PCS (Extra 1)</p>	<p>Magnet 1 PC</p>	<p>Shelf Holder 4 PCS (Extra 1)</p>	<p>Screw 16 PCS (Extra 1)</p>
<p>#11</p> 	<p>#12</p> 	<p>#13</p> 		
<p>Adjustable Leveler 4 PCS</p>	<p>Allen Wrench 1 PC</p>	<p>Safety Strap Kit 1 SET</p>		

ADDITIONAL TOOLS (Not Provided)

Note: It is not recommended to use power tools during assembly.

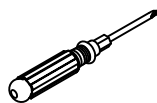

Phillips Head Screwdriver

Note: Wood dowels are intended for alignment. Additional clearance between wood dowel and pre-drilled hole is intentional for ease of assembly.

Step 1. Attach magnet (part #8) to top panel (part A) using round head screws (part #5) and phillips head screwdriver. Attach handles (part #6) to door panels (parts F & G) using round head bolts (part #7) and phillips head screwdriver. Attach adjustable levelers (part #11) to legs (part I).

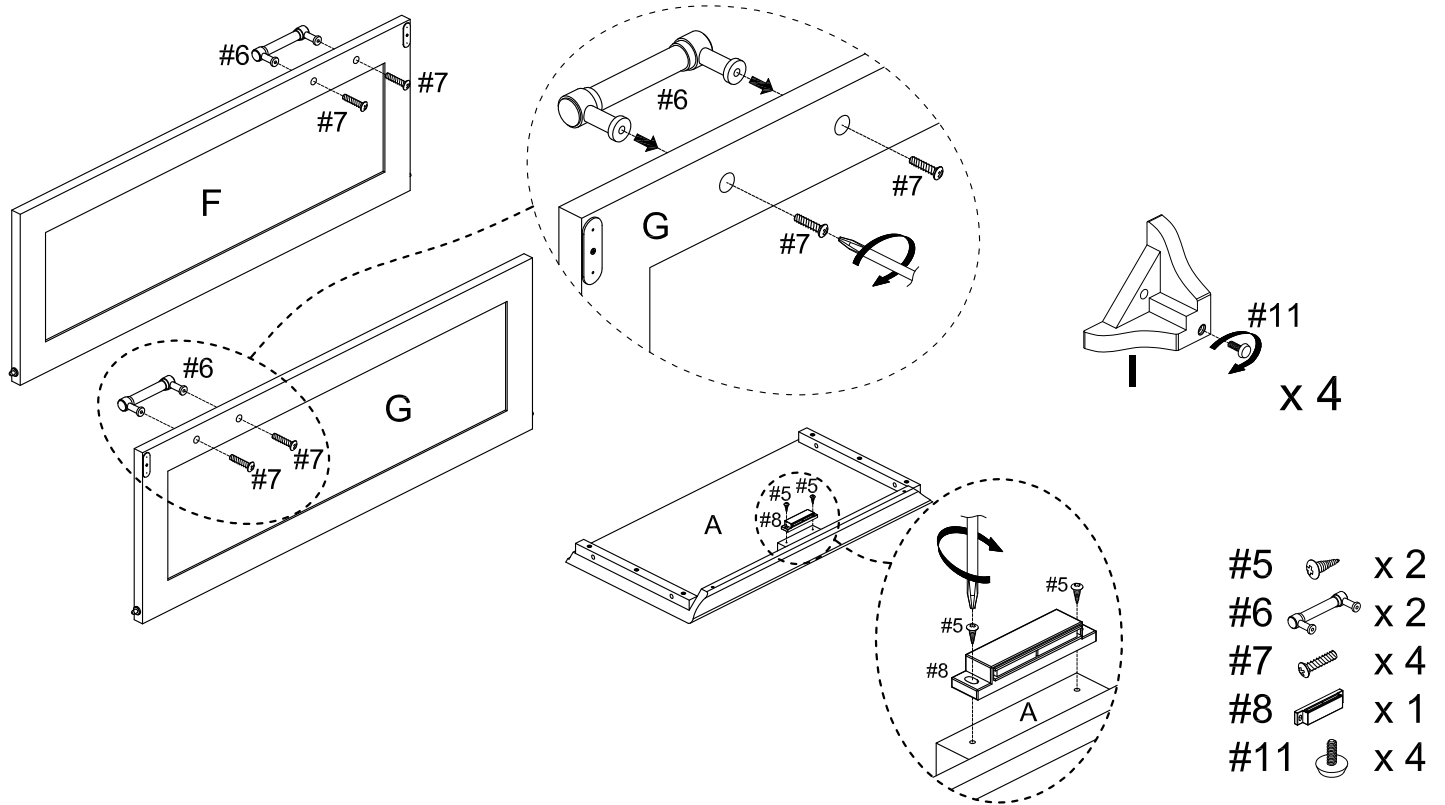

Step 2. Attach top panel (part A) and bottom panel (part B) to right panel (part D) using bolts (part #2) and allen wrench (part #12).

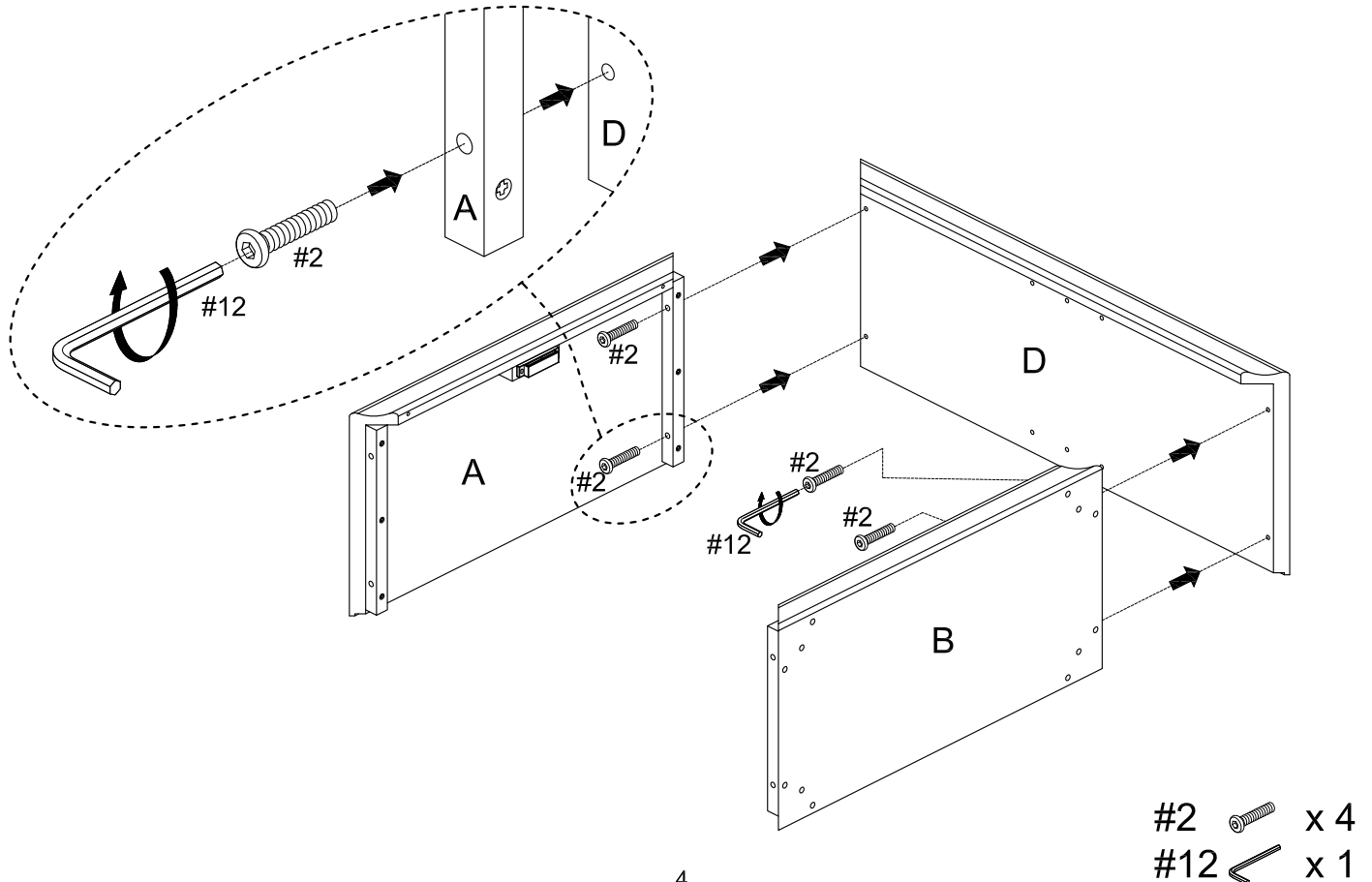

Step 3. Attach left panel (part C) to assembled unit (parts A & B) using bolts (part #2) and allen wrench (part #12).

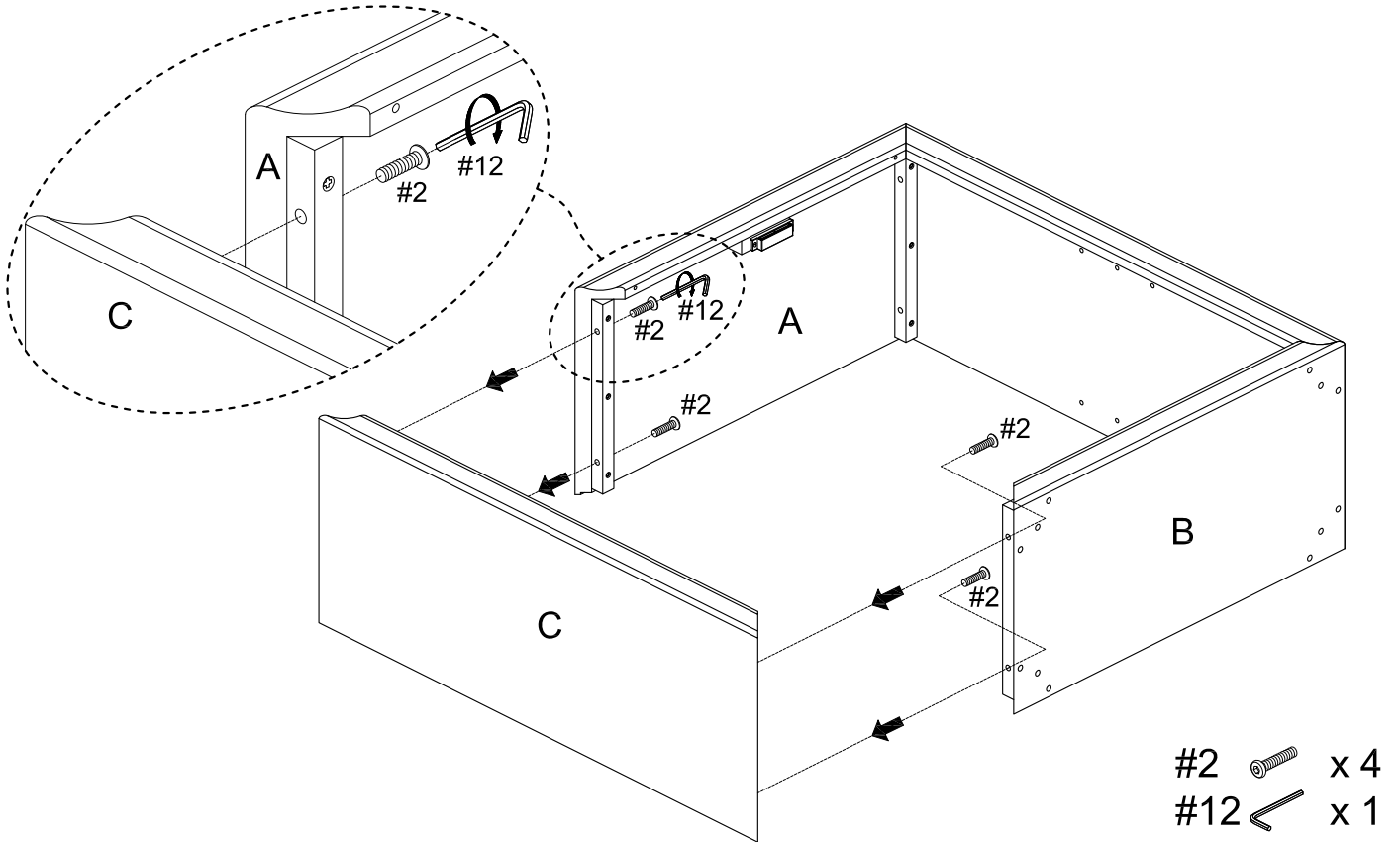

Step 4. Attach legs (part I) to bottom panel (part B) using wood dowels (part #1), bolts (part #2), flat washers (part #3), spring washers (part #4) and allen wrench (part #12).

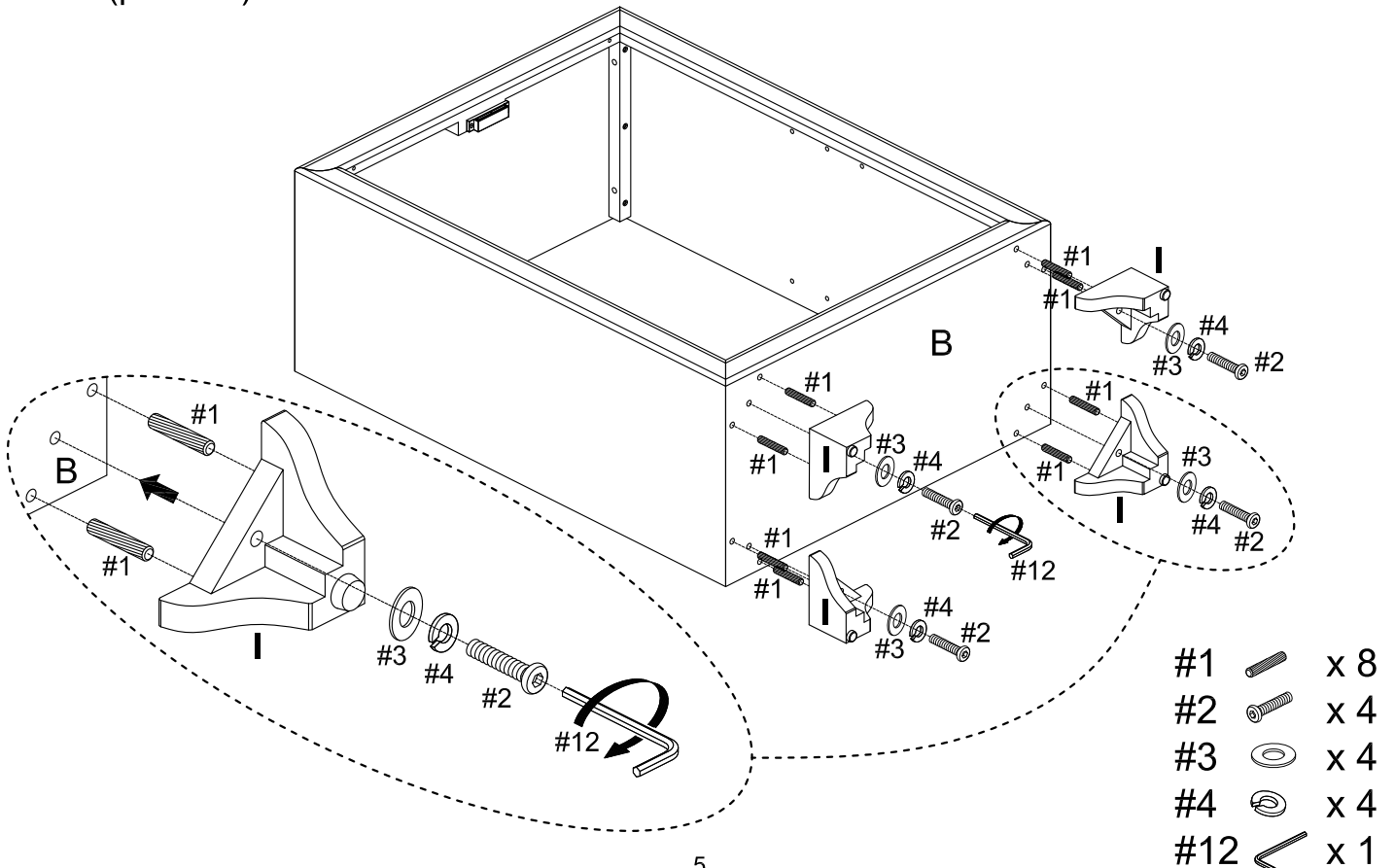

Step 5. Carefully turn unit upright. Attach back panel (part H) to assembled unit (parts A, B, C & D) using screws (part #10) and phillips head screwdriver.

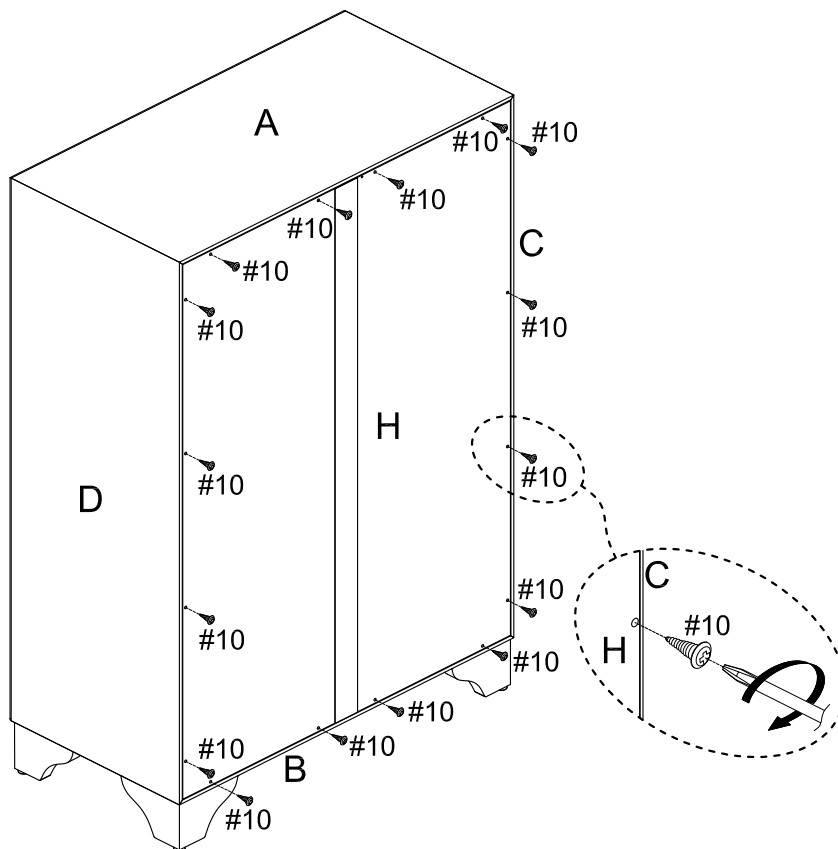

#10  x 16

Step 6. Place shelf holders (part #9) into desired position and then slide adjustable shelf (part E) into place.

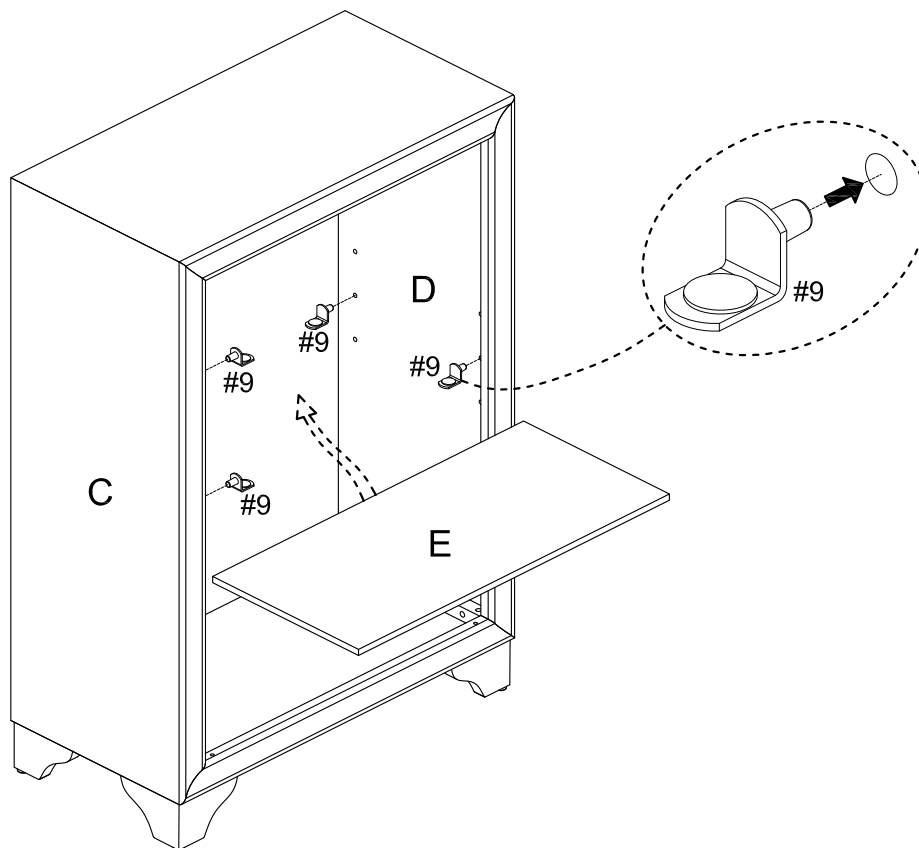

#9  x 4



Step 7. Attach door panels (parts F & G) by placing bottom pin hinge (pre-installed in door) in the pre-drilled hole of bottom panel (part B). Then depress the top spring-loaded pin hinge so it can be placed in the pre-drilled hole of top panel (part A).

NOTE: Be sure top and bottom pin hinges are fully extended to secure doors in place.

NOTE: It is important to adjust levelers once fully assembled and upright. Extend adjustable leveler until it's firmly in contact with the floor. If relocating, adjust leveler as needed until it's firmly in contact with the floor in new location.

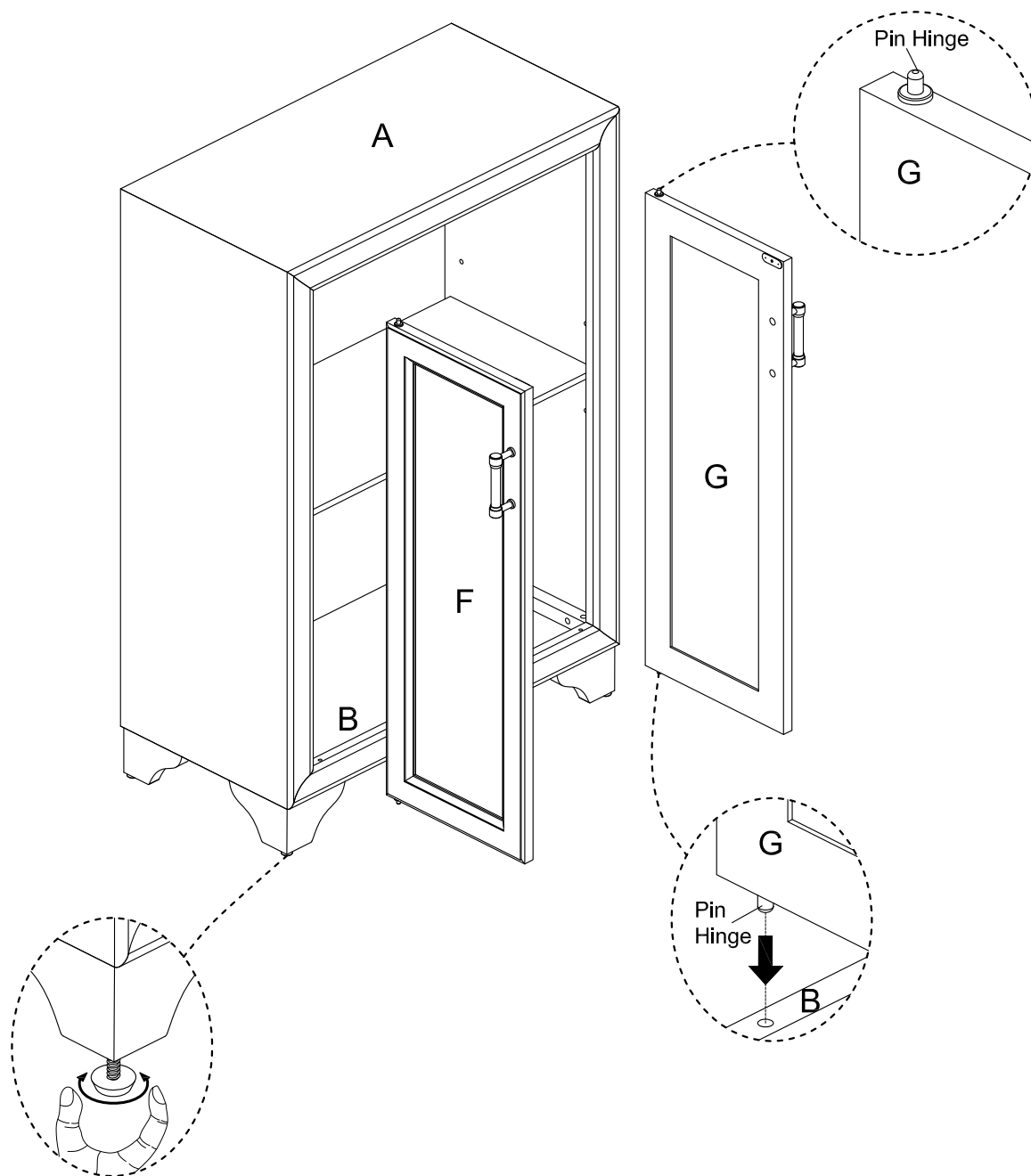
Important: Safety strap kit (part #13) must be installed to prevent tipping, damage and/or injury.

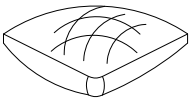
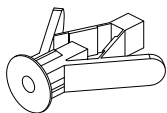

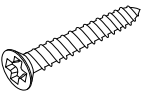
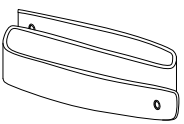
#13	A	B	C	D	E
					
Safety Strap Kit	Wall Anchor	Washer	Short Screw	Long Screw	Safety Wall Strap
1 SET	1 PC	2 PCS	1 PC	1 PC	1 PC

SAFETY WALL STRAP INSTALLATION

Note: It is highly recommended to install this safety strap kit to prevent tipping, damage and/or injury.

1. Insert short screw (C) through washer (B) and safety wall strap (E) and attach to top panel (part A) using phillips head screwdriver.
2. Drill a 11/32" hole where you want to secure the unit. The drilled hole will be at the same height as the hole in top panel (part A) where the safety wall strap (E) is attached. Tap wall anchor (A) into the hole.
3. Insert long screw (D) through washer (B) and safety wall strap (E) into wall anchor (A) using phillips head screwdriver.

Note: This item is not intended for clothing storage use.

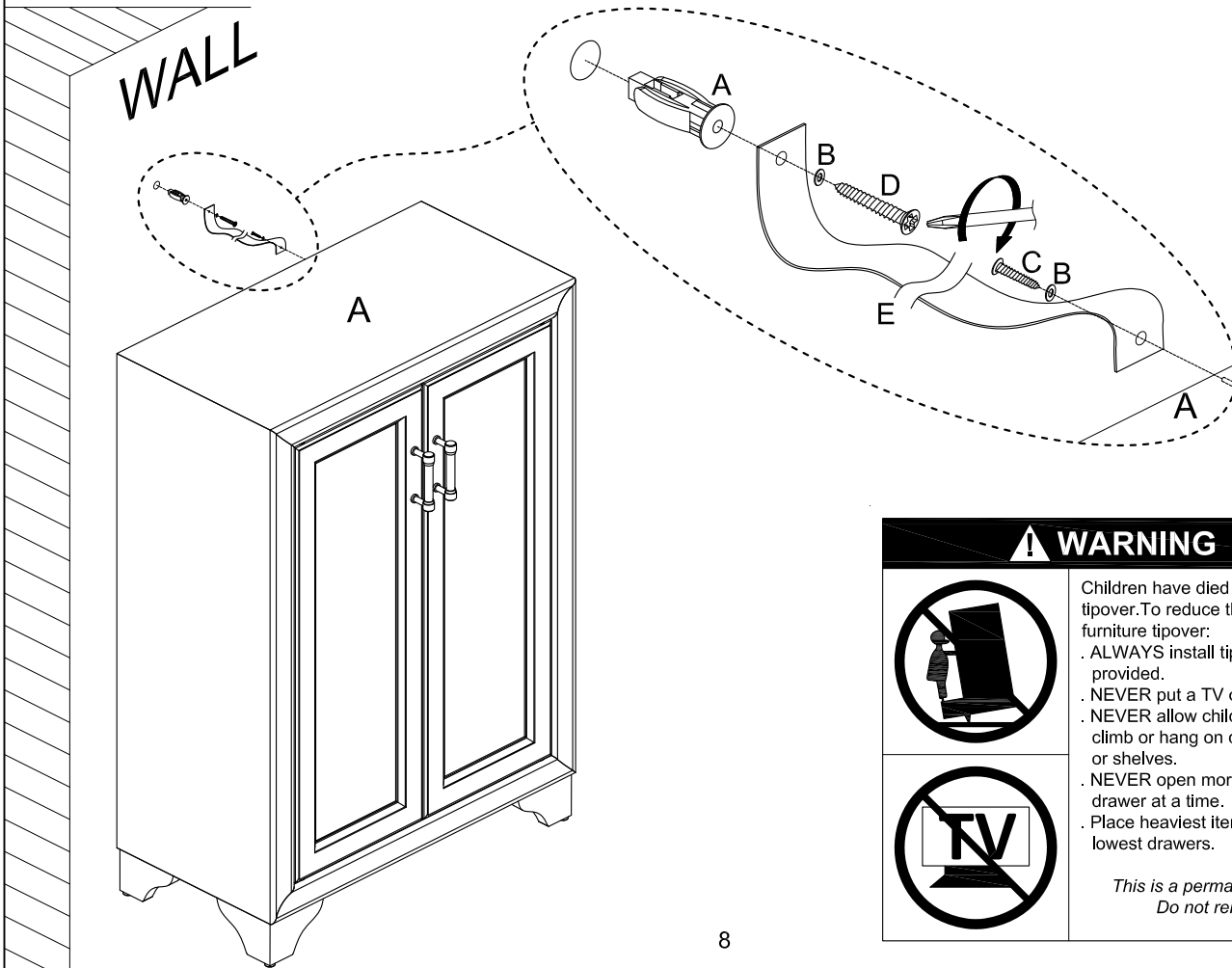

⚠ WARNING



Children have died from furniture tipover. To reduce the risk of furniture tipover:

- ALWAYS install tipover restraint provided.
- NEVER put a TV on this product.
- NEVER allow children to stand, climb or hang on drawers, doors, or shelves.
- NEVER open more than one drawer at a time.
- Place heaviest items in the lowest drawers.

*This is a permanent label.
Do not remove!*