

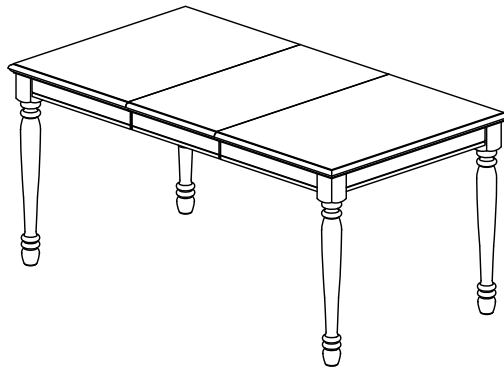

Dining Table
CF2002

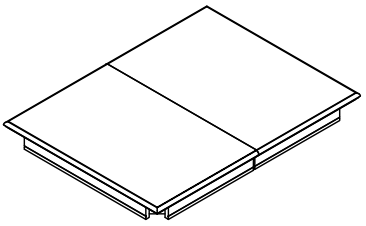
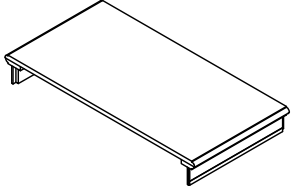
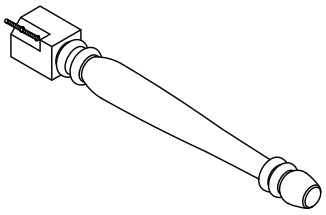

PART LIST

<div data-bbox="167 235 231 302" data-label="Text"> <p>A</p> </div> 	<div data-bbox="598 235 662 302" data-label="Text"> <p>B</p> </div> 	<div data-bbox="1029 235 1093 302" data-label="Text"> <p>C</p> </div> 
<p>Table Top 1 PC</p>	<p>Table Leaf 1 PC</p>	<p>Leg 4 PCS</p>

HARDWARE LIST

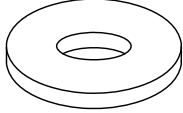
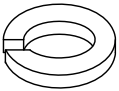
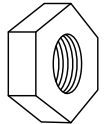
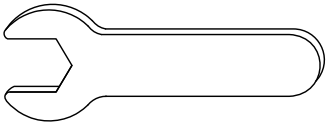
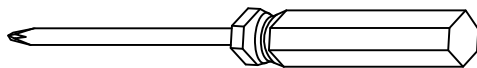
<div data-bbox="167 974 231 1041" data-label="Text"> <p>#1</p> </div> 	<div data-bbox="598 974 662 1041" data-label="Text"> <p>#2</p> </div> 	<div data-bbox="1029 974 1093 1041" data-label="Text"> <p>#3</p> </div> 
<p>Flat Washer 8 PCS</p>	<p>Spring Washer 8 PCS</p>	<p>Nut 8 PCS</p>
<div data-bbox="167 1512 231 1579" data-label="Text"> <p>#4</p> </div> 	<p>ADDITIONAL TOOLS (Not Provided) Note: It is not recommended to use power tools during assembly.</p>  <p>Phillips Head Screwdriver</p>	
<p>Wrench 1 PC</p>		

Step 1. Before assembly remove four corner connectors (See Figure 1) and two wood connectors (See Figure 2) using phillips head screwdriver. Carefully turn table top (part A) upside down on a soft flat surface, such as carpet. Attach legs (part C) to table top (part A) using flat washers (part #1), spring washers (part #2), nuts (part #3) and wrench (part #4).

Note: Please fully tighten all bolts.

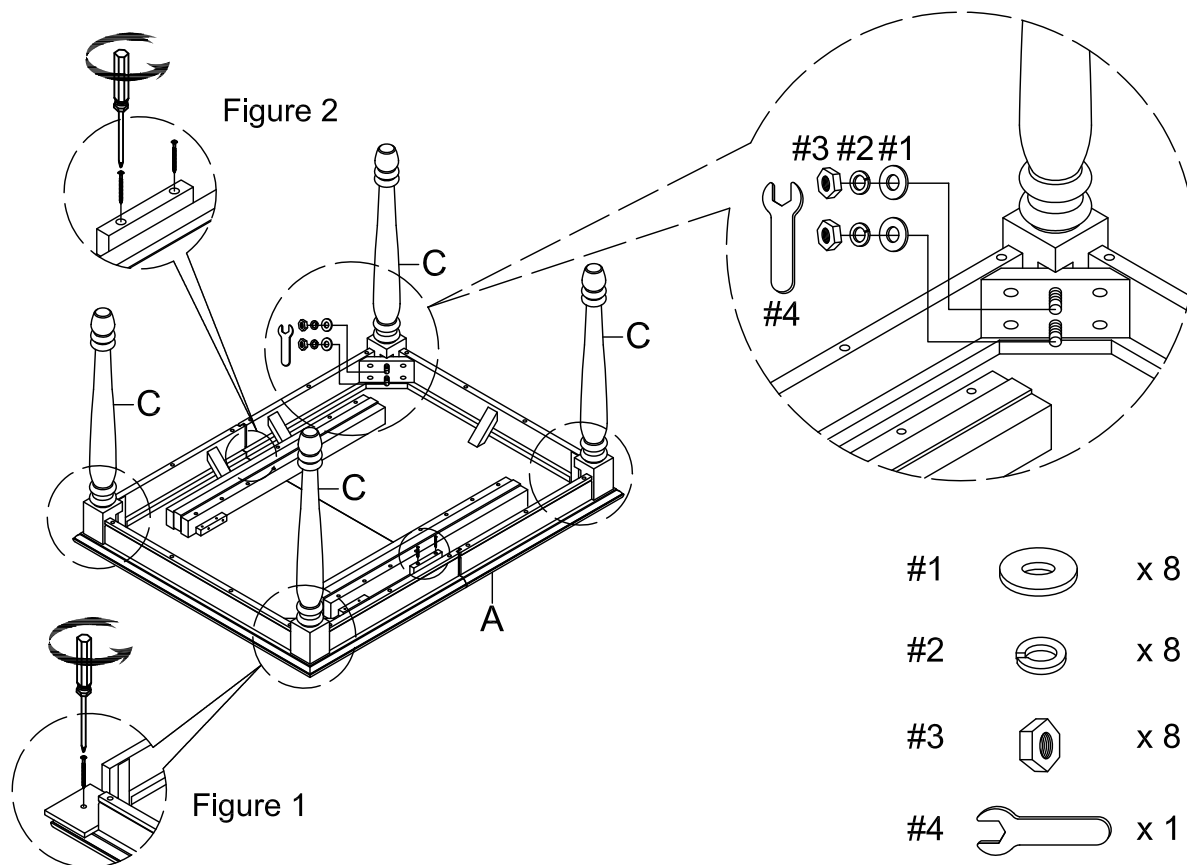

Step 2. Carefully turn unit upright. To insert table leaf (part B), unlock the clamp locks underneath table top (part A) and pull on opposite ends to separate.

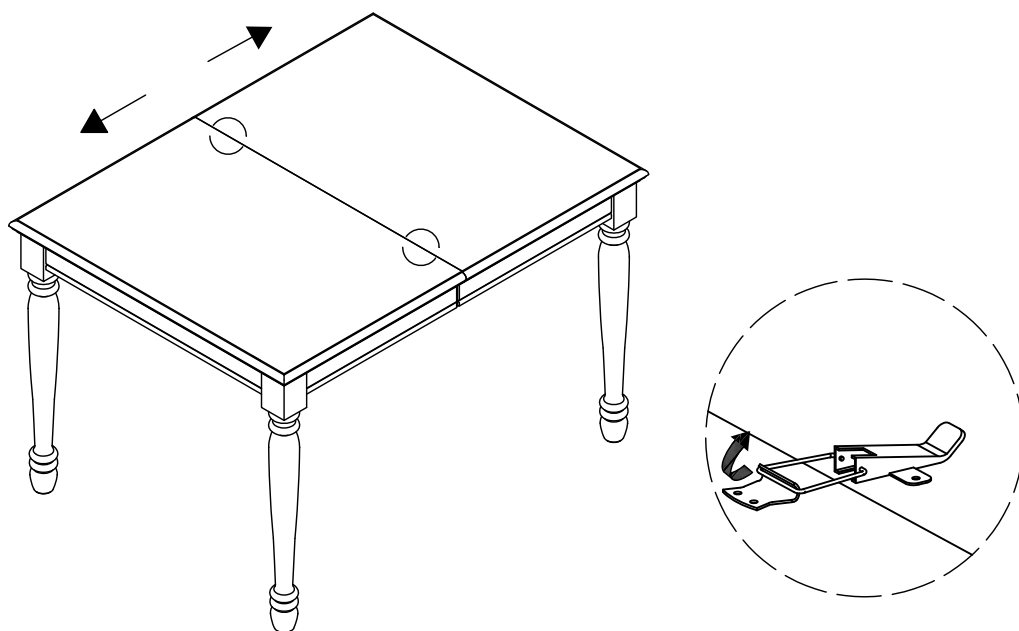

Step 3. Place table leaf (part B) in position and push table top (part A) from both ends to close.

Note: Ensure clamp locks line up correctly when inserting table leaf (part B).

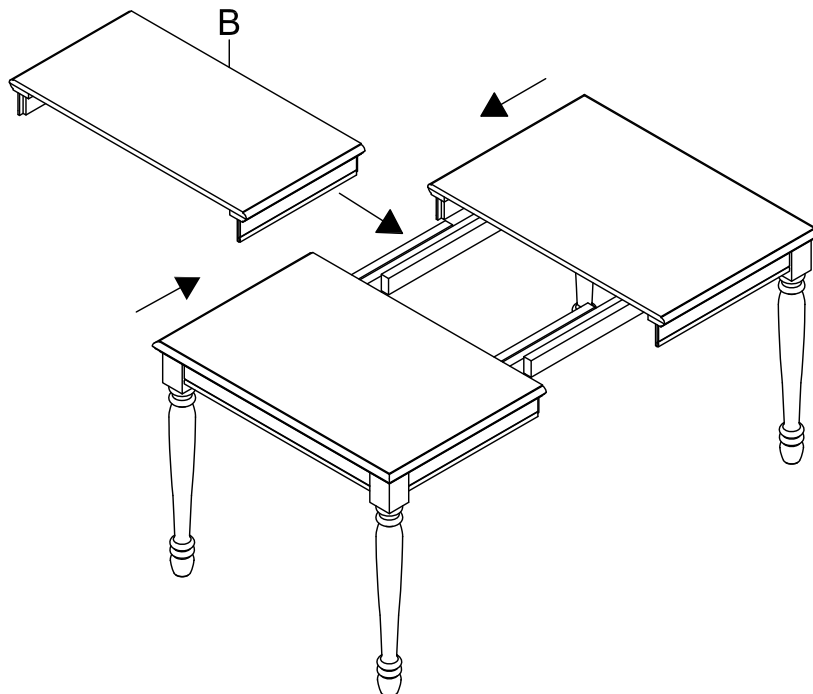

Step 4. Lock clamp locks underneath table top (part A) to secure.

