

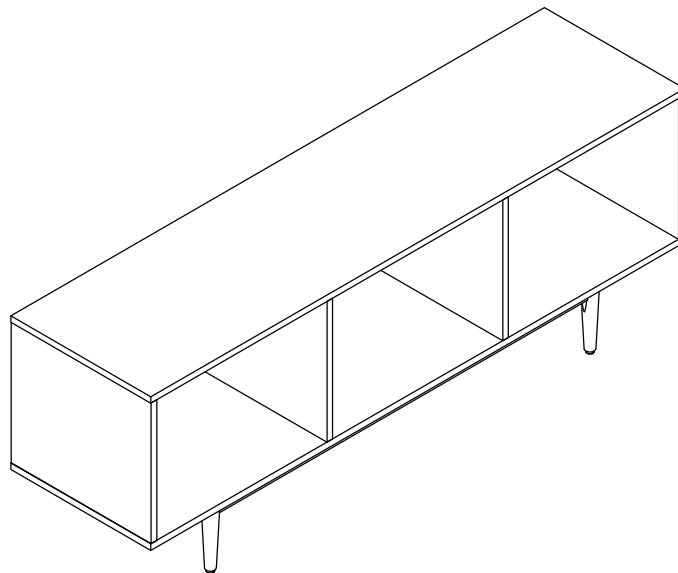

CROSLEY

FURNITURE



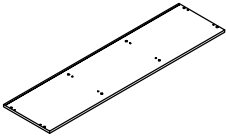
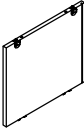
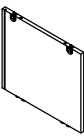
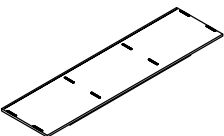
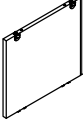
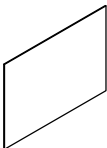

Large Record Storage
Console Cabinet
CF1115

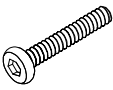

PART LIST

A 	B 	C 	D 	E 
Top Panel 1 PC	Left Panel 1 PC	Right Panel 1 PC	Bottom Panel 1 PC	Partition Panel 2 PCS
F 	G 	H 		
Back Panel 3 PCS	Leg 4 PCS	Center Leg 1 PC		

HARDWARE LIST

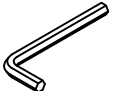
#1 	#2 	#3 	#4 	#5 
Ø3*15mm Screw 4 PCS	Ø1/4"*1-1/2" Bolt 8 PCS (Extra 1)	Ø1/4" Flat Washer 8 PCS (Extra 1)	Ø1/4" Spring Washer 8 PCS (Extra 1)	Ø8*30mm Wood Dowel 8 PCS (Extra 1)
#6 	#7 			
Back Bracket 4 PCS	4mm Allen Wrench 1 PC			

ADDITIONAL TOOLS (Not Provided)

Note: It is not recommended to use power tools during assembly.

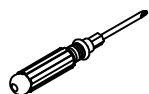

Phillips Head Screwdriver

Note: Wood dowels are intended for alignment. Additional clearance between wood dowel and pre-drilled hole is intentional for ease of assembly.

Please do not use tools to assemble this unit unless specifically indicated.

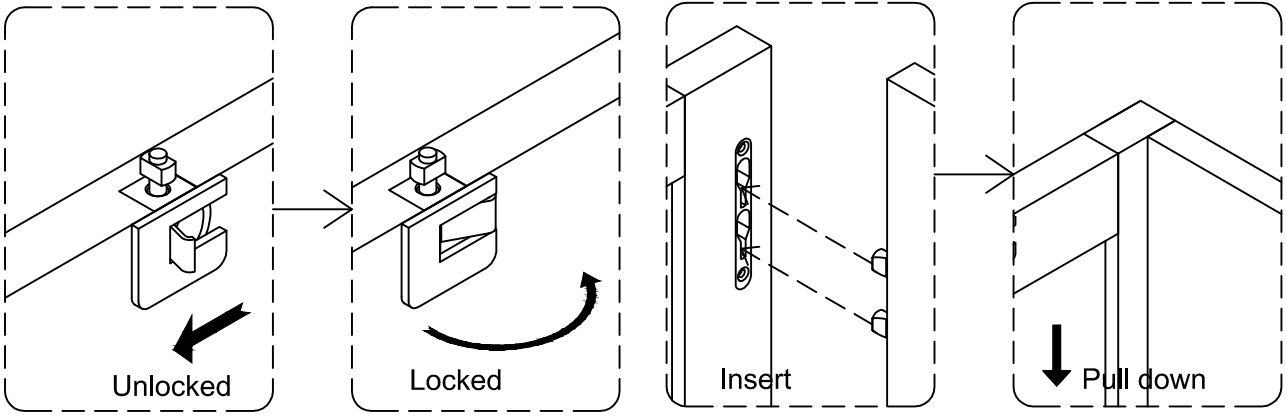



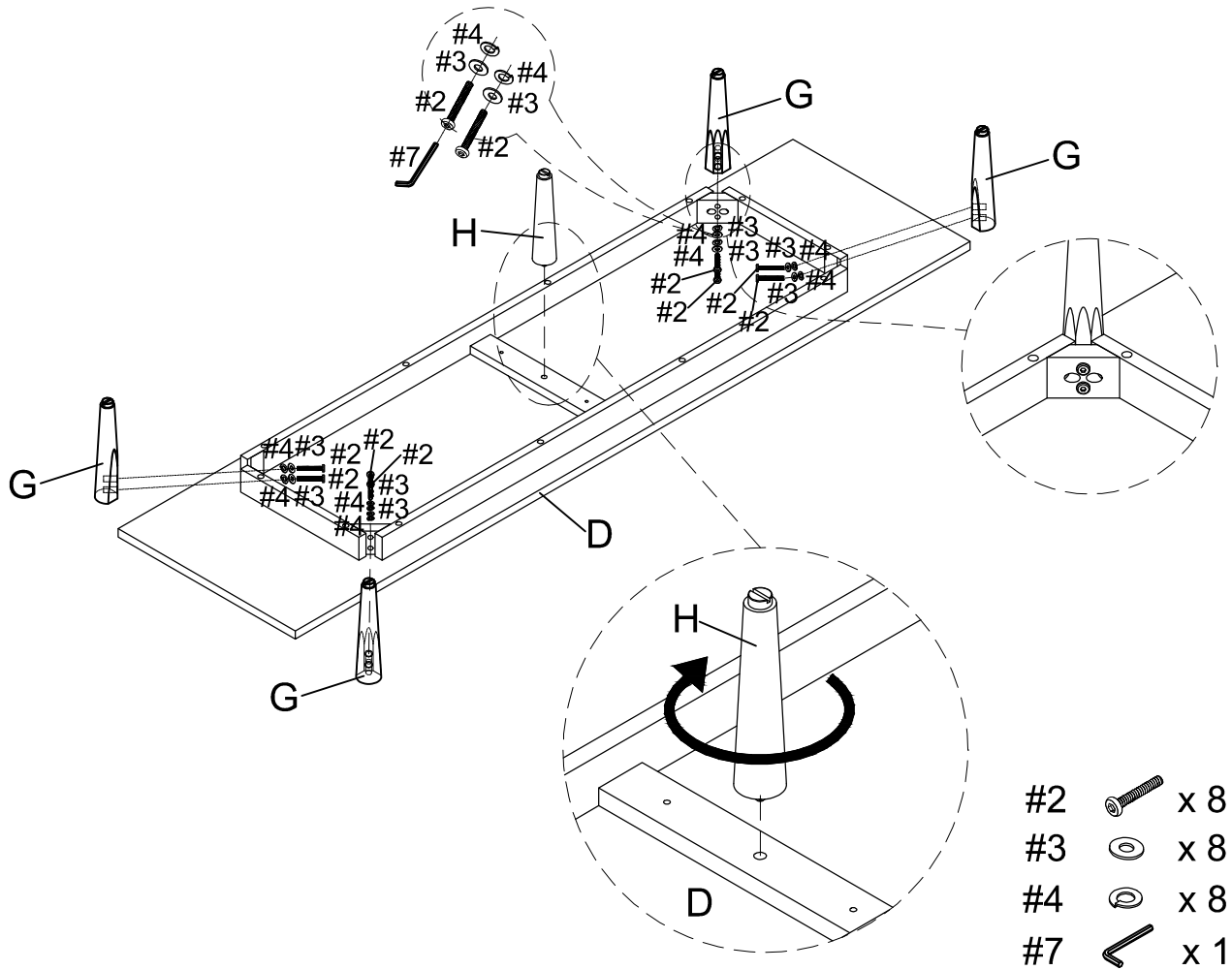

Reference the images above any time the instructions state "lock the hardware" or "insert hardware and pull down to lock".

Be sure to check all hardware is locked when complete.

Step 1. Attach legs (part G) to bottom panel (part D) using spring washers (part #4), flat washers (part #3), bolts (part #2) and allen wrench (part #7). Screw in center leg (part H) into designated hole as shown.



- #2  x 8
- #3  x 8
- #4  x 8
- #7  x 1

Step 2. Carefully turn unit upright. Attach left panel (part B), right panel (part C) and partition panels (part E) to bottom panel (part D) pull down to lock.

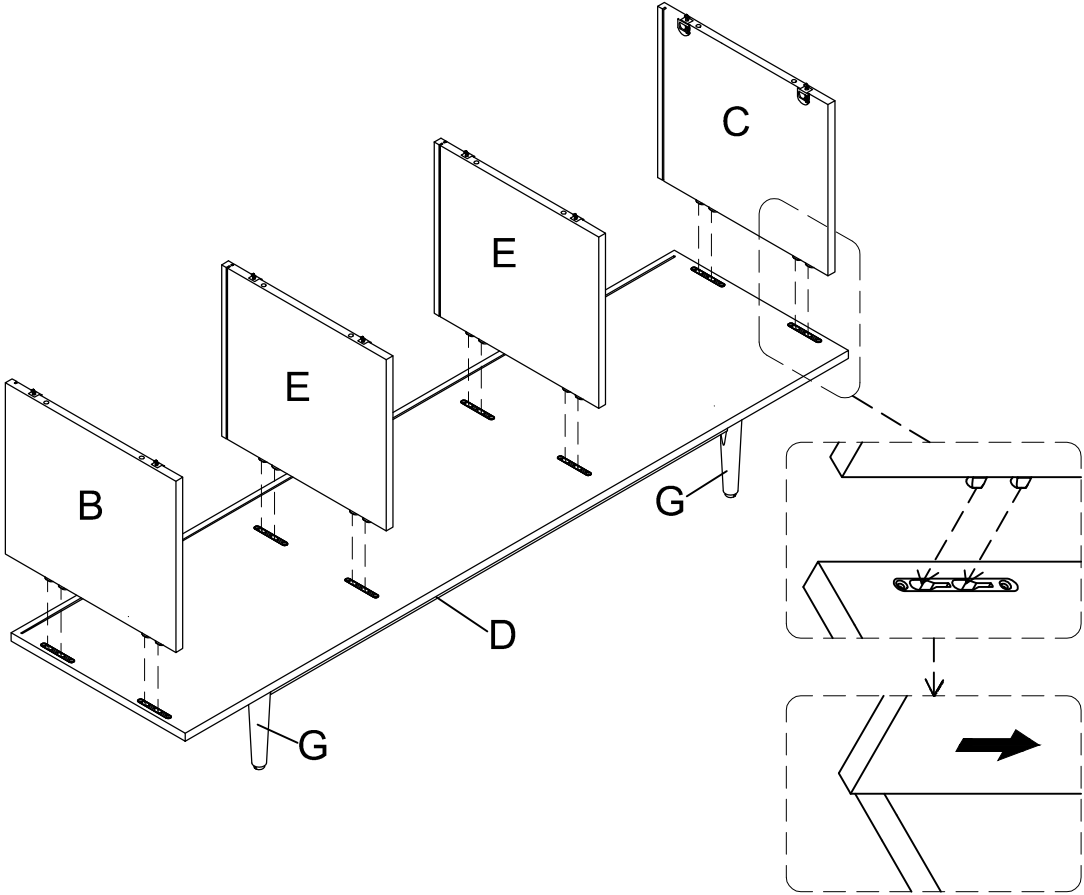

Step 3. Insert back panels (part F) into grooves of assembled unit (parts B, C, D & E).

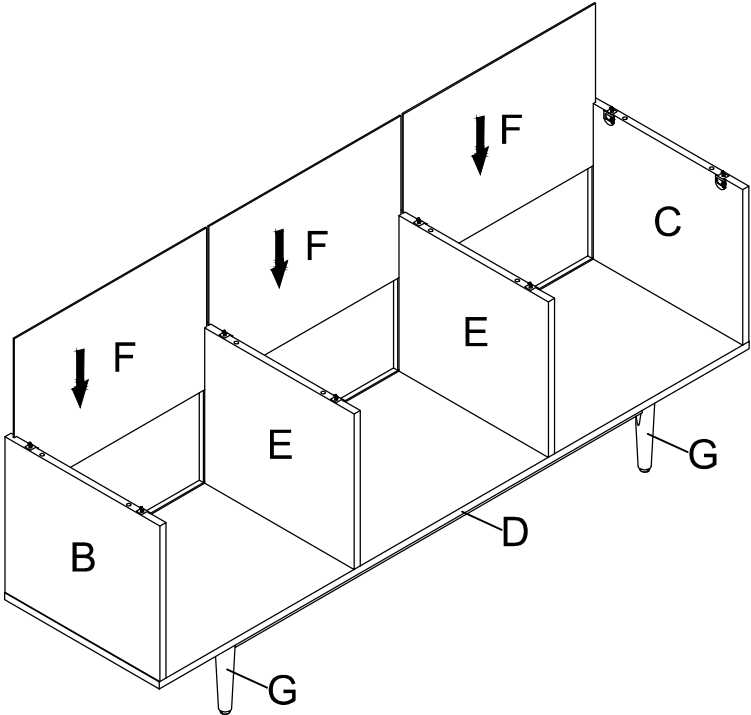

Step 4. Attach top panel (part A) to assembled unit (parts B, C & E) using wood dowels (part #5) and lock the hardware.

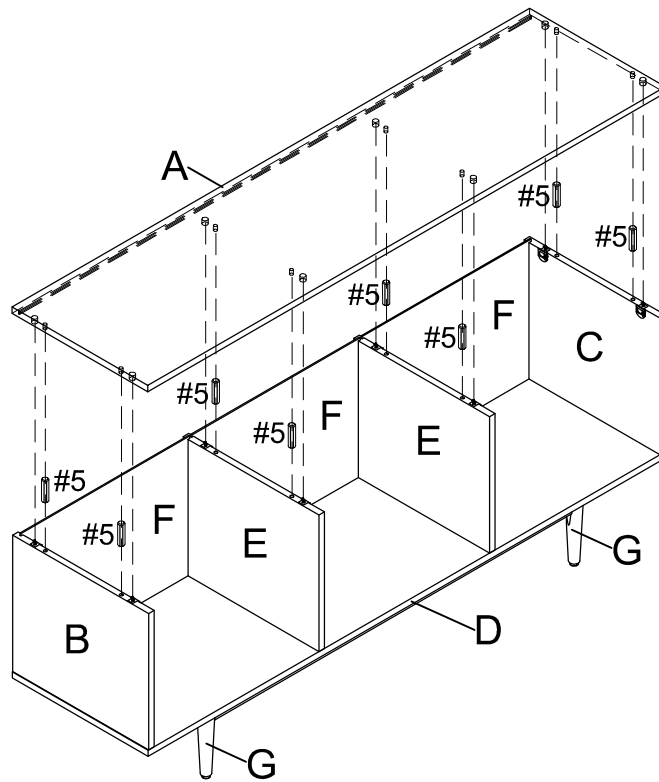

#5  x 8

Step 5. Secure back brackets (part #6) at the corner of back panels (part F) using screws (part #1) and phillips head screwdriver.

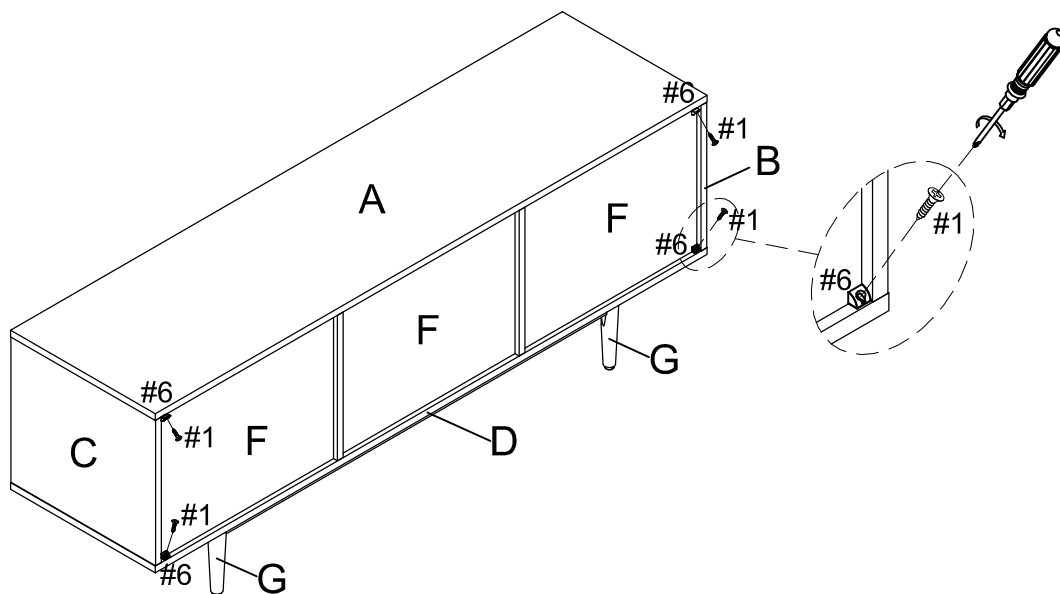

#1  x 4
 #6  x 4