



THANK YOU FOR PURCHASING THIS QUALITY PRODUCT.  
BE SURE TO CHECK ALL PACKING MATERIAL CAREFULLY FOR SMALL PARTS  
THAT MAY HAVE COME LOOSE INSIDE THE CARTON DURING TRANSIT.

PART LIST

NO	DECS	DIZE(IN)	SKETCH	QTY
A	Leg	39.37*13.78*2.56		2PC
B	Link	37.4*1*1		4PC
C	Glass lid	39.37*39.37*3.54		1PC

HARDWARE LIST

NO	DECS	DIZE(IN)	SKETCH	QTY
a	FLAT GLIDE	1"		4PCS
b	SCREW	5/16"		8PCS
c	ALLEN KEY	M5		1PC

Step 1

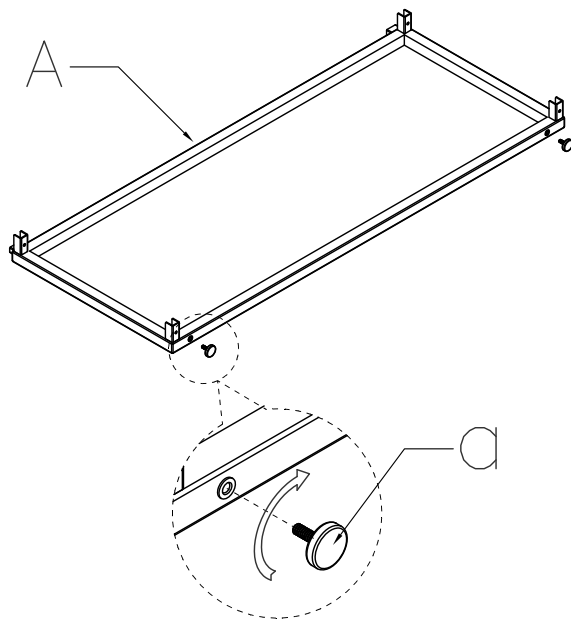

Step 2

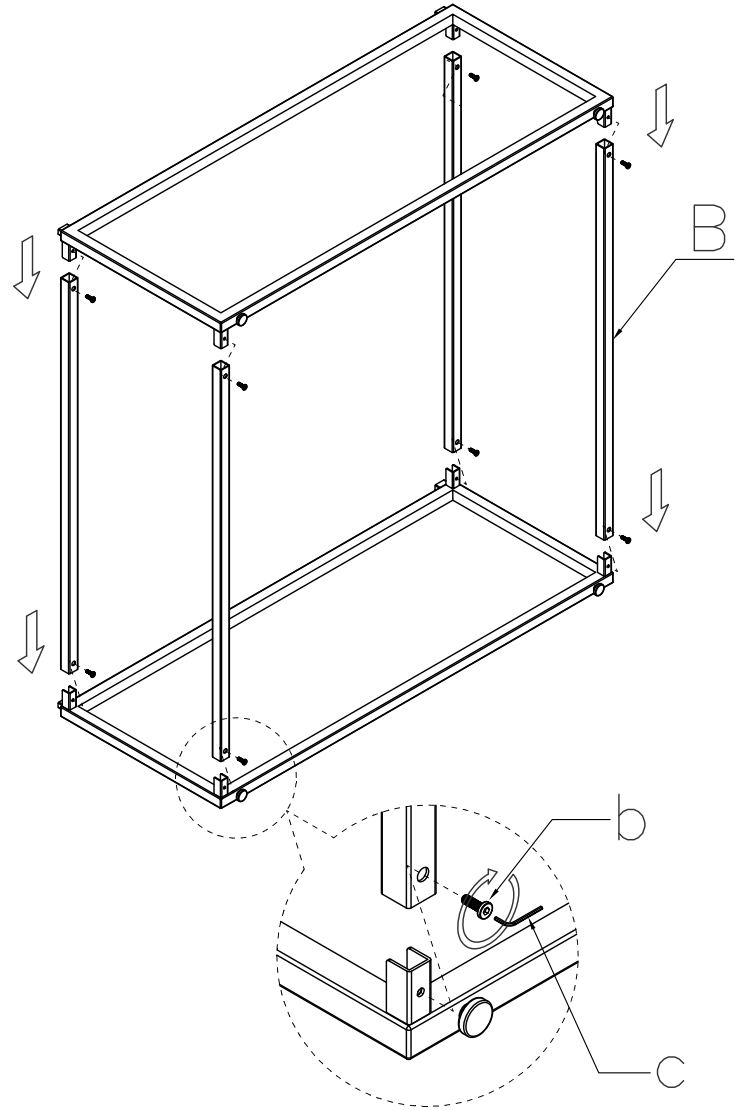

Step 3

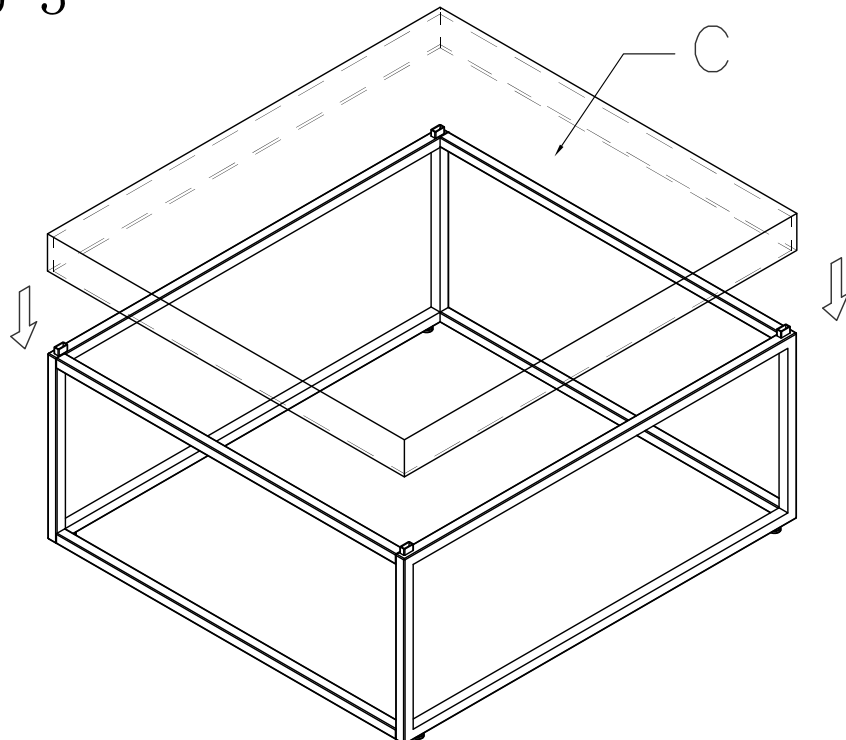

Finish

