

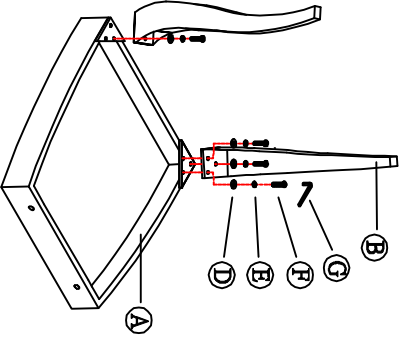

Chintaly Imports

Step 1



Step 2

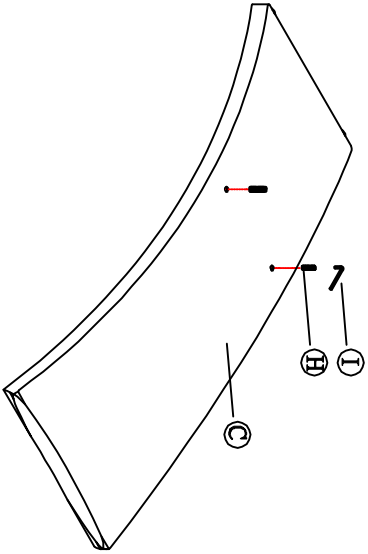



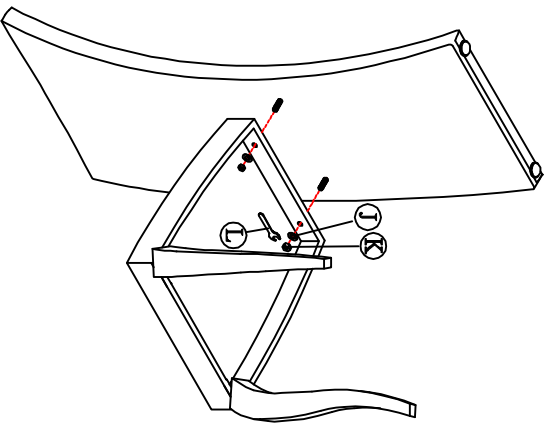



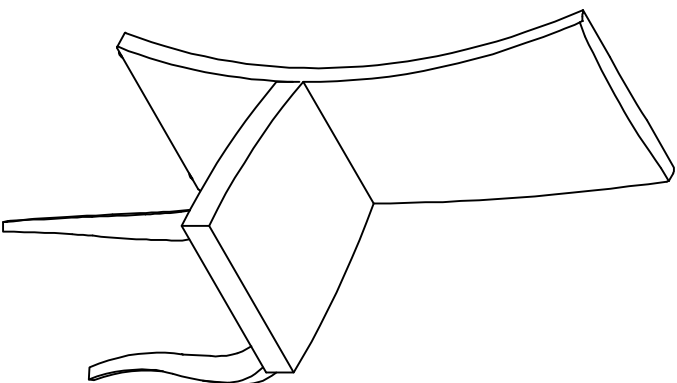

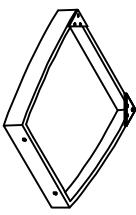



Step 3



Step 4



 A × ①	 B × ①	 C × ①	 D × ① M6	 E × ① M6	 F × ① M6*15MM	 G × ② M10*45MM	 H × ① 5mm	 I × ② M10	 J × ② M10	 K × ② M10	 L × ① 17MM
--	--	--	--	--	---	--	---	---	---	---	--