

THANK YOU FOR PURCHASING THIS QUALITY PRODUCT.

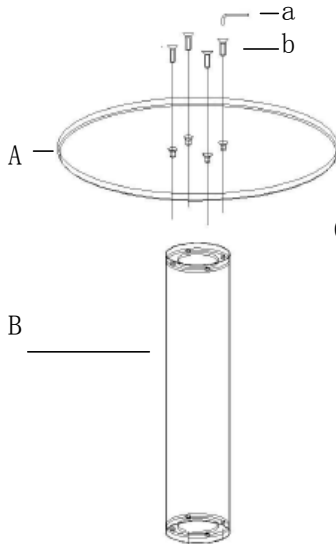

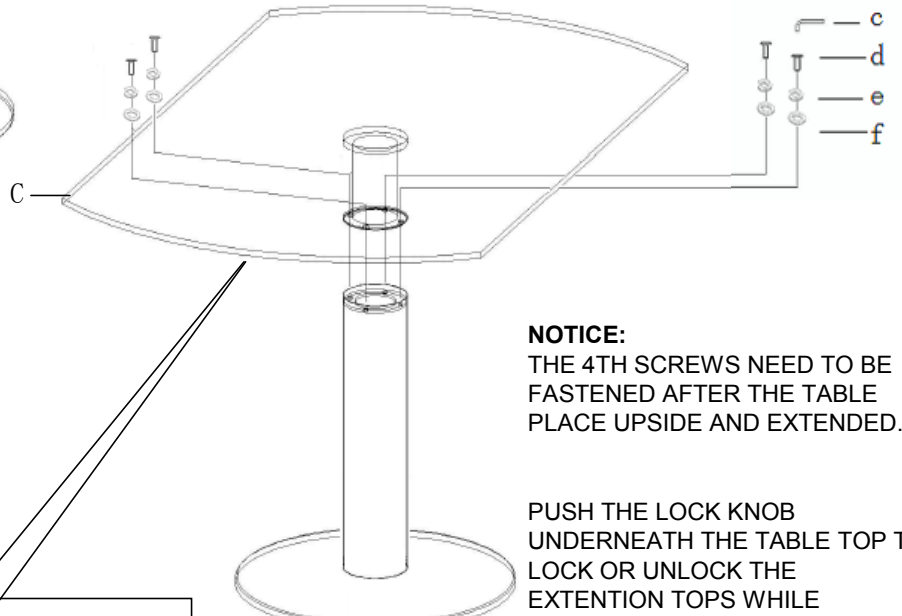

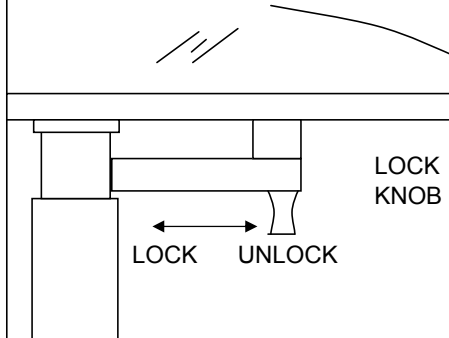

BE SURE TO CHECK ALL PACKING MATERIAL CAREFULLY FOR SMALL PARTS THAT MAY HAVE COME LOOSE INSIDE THE CARTON DURING TRANSIT.

**STEP 1**

**STEP 2**

**NOTICE:**



THE 4TH SCREWS NEED TO BE FASTENED AFTER THE TABLE PLACE UPSIDE AND EXTENDED.

PUSH THE LOCK KNOB UNDERNEATH THE TABLE TOP TO LOCK OR UNLOCK THE EXTENSION TOPS WHILE USAGES.

**LOCK FUNCTION:**

**HARDWARE LIST**

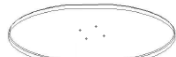
NO	DESC	SKETCH	QTY
a	ALLEN KEY	 8mm	1PC
b	SCREW		4PCS
c	ALLEN KEY	 5mm	1PC
d	SCREW		4PCS
e	SPRING WASHER		4 PCS
f	FLAT WASHER		4PCS

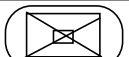
**PART LIST**

NO	DESC	SKETCH	QTY
A	BASE		1 PC
B	PILLAR		1 PC
C	TABLE TOP		1 PC

ATTENTION: PLEASE DO NOT RAISE THE FRAME ONLY WHEN RAISE UP AND MOVE OUT THE ASSEMBLED TABLE OUTSIDE THE PACKAGING. WHEN PLACE THE TABLE UPSIDE, HOLD THE METAL FRAME AND ALSO THE GLASS TO AVIOD THE GLASS BREAKGE

AFTER ASSEMBLED THE TABLE, USE ALLEN KEY(a) TO LEVEL THE GLASS TOPS.