



THANK YOU FOR PURCHASING THIS QUALITY PRODUCT.

BE SURE TO CHECK ALL PACKING MATERIAL CAREFULLY FOR SMALL PARTS THAT MAY HAVE COME LOOSE INSIDE THE CARTON DURING TRANSIT.

STEP 1

Place the seat on a soft cloth, then screwed the seat on the wood frame

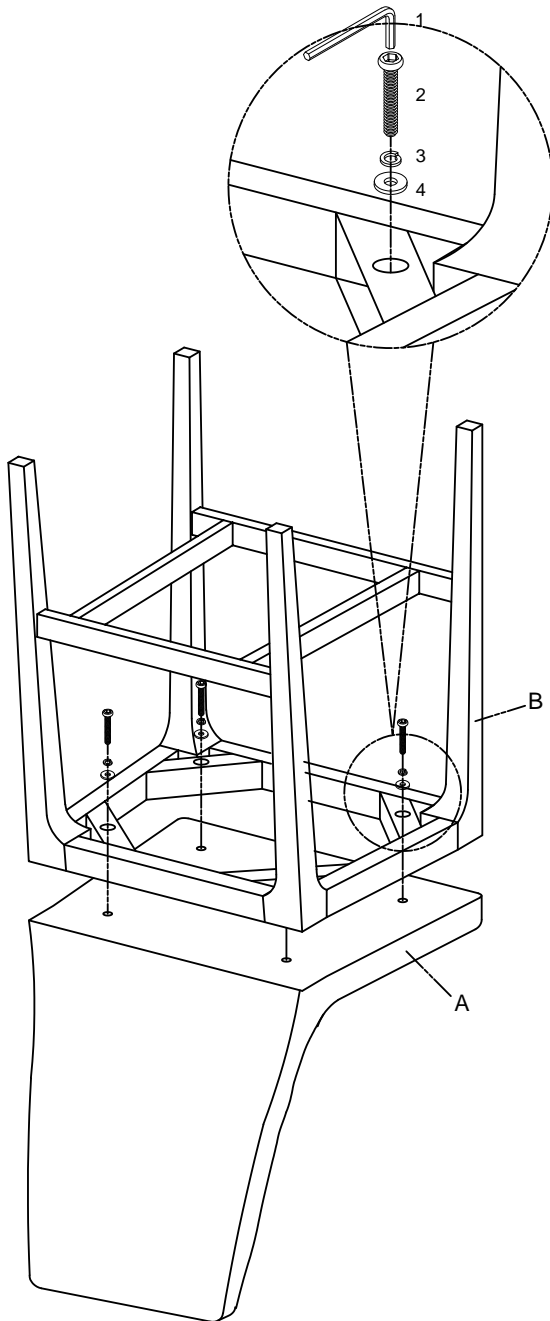

PART LIST

NO	DESC	SIZE (MM)	SKETCH	QTY
A	Seat	480x485x500		1 PC
B	Wood Frame	522x463x605		1 PC

HARDWARE LIST

NO	DESC	SIZE (MM)	SKETCH	QTY
1	Allen Key	4mm		1PC
2	Bolt	6x50.8mm		4PCS
3	Spring Washer	6mm		4PCS
4	Flat Washer	6x19mm		4PCS

FINISHED

