





THANK YOU FOR PURCHASING THIS QUALITY PRODUCT.

BE SURE TO CHECK ALL PACKING MATERIAL CAREFULLY FOR SMALL PARTS THAT MAY HAVE COME LOOSE INSIDE THE CARTON DURING TRANSIT.

PART LIST

NO	DESC	SIZE (MM)	SKETCH	QTY
A	SEAT			1PCS
B	Base			1PCS

HARDWARE LIST

NO	DESC	SIZE (MM)	SKETCH	QTY
1	BOLT	M6*20		4 PCS
2	WASHER	Ø16*2		4 PCS
3	SPANNER	4#		1PCS

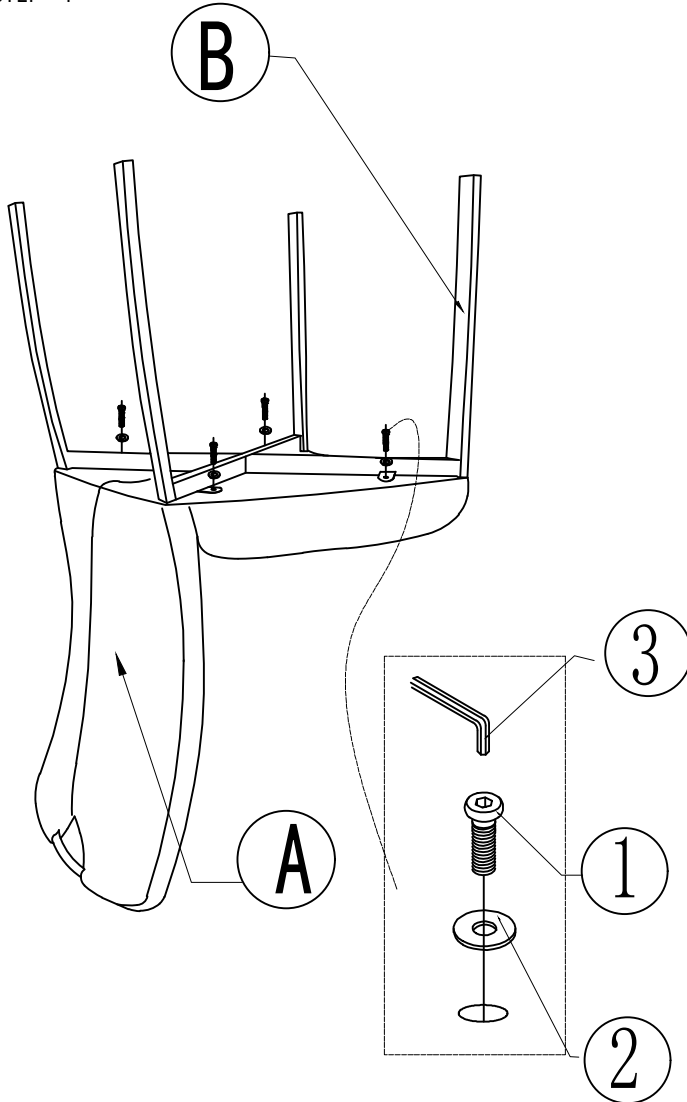
STEP 1

STEP 2
