



THANK YOU FOR PURCHASING THIS QUALITY PRODUCT.

BE SURE TO CHECK ALL PACKING MATERIAL CAREFULLY FOR SMALL PARTS THAT MAY HAVE COME LOOSE INSIDE THE CARTON DURING TRANSIT.

PART LIST

NO	DESC	SIZE (MM)	SKETCH	QTY
A	Bucket	1400*800*10		1PCS
B	Base	745*50*50		1PCS

STEP 1

HARDWARE LIST

NO	DESC	SIZE (MM)	SKETCH	QTY
1	SCREW	M6*50		4 PCS
2	WASHER	M6*16		4PCS
3	ALLEN KEY	4MM		1 PCS

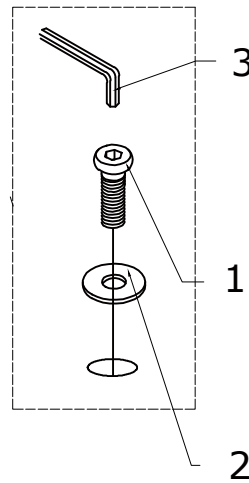
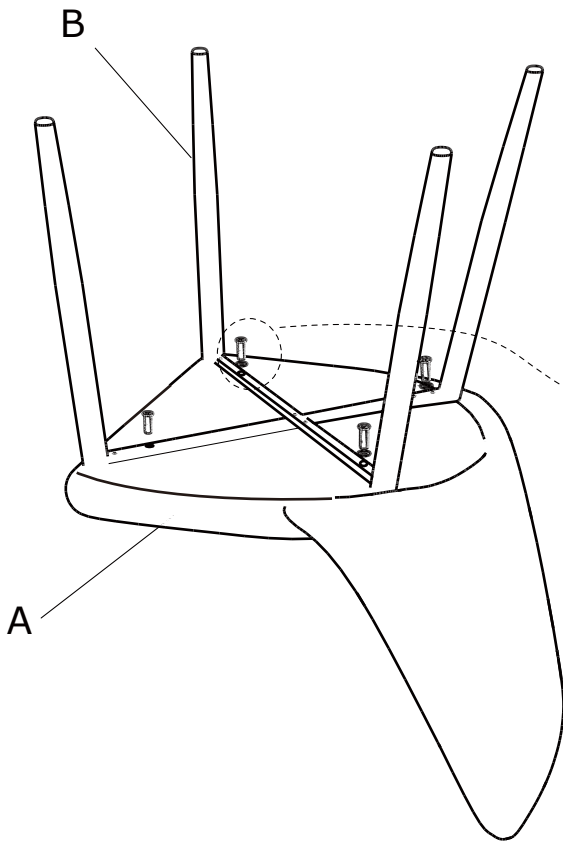

STEP 2

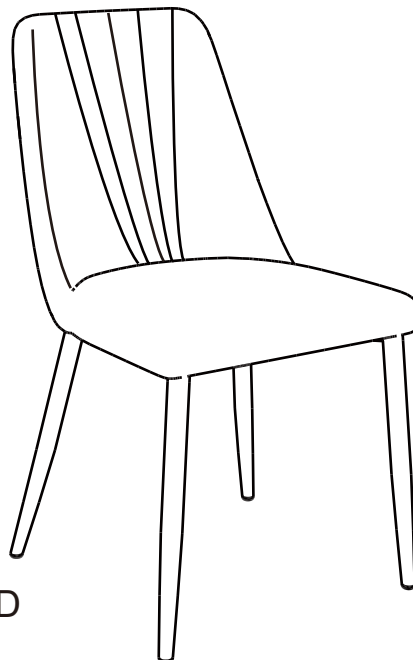

FINISHED

MADE IN CHINA