

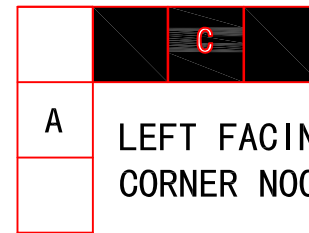

THANK YOU FOR PURCHASING THIS QUALITY PRODUCT.

BE SURE TO CHECK ALL PACKING MATERIAL CAREFULLY FOR SMALL PARTS THAT MAY HAVE COME LOOSE INSIDE THE CARTON DURING TRANSIT.

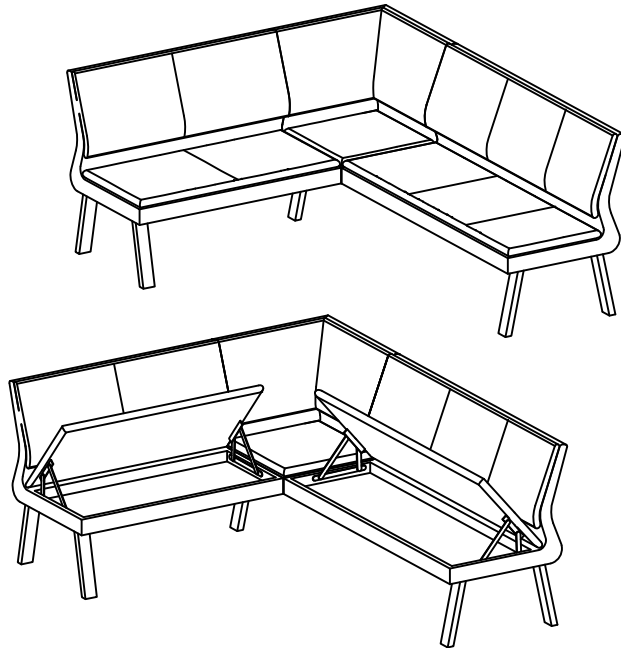



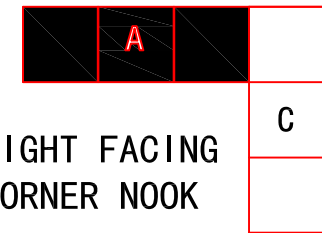

LEFT FACING
CORNER NOOK





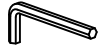

RIGHT FACING
CORNER NOOK

THIS PRODUCT IS A REVERSIBLE NOOK. THERE ARE RIGHT FACING CORNER NOOK AND LEFT FACING CORNER NOOK OPTIONS FOR YOUR DEMAND. YOU CAN FOLLOW THE ASSEMBLY STEPS TO FINISH THE RIGHT FACING CORNER NOOK OR LEFT FACING CORNER NOOK.

HARDWARE LIST:

NO	DESCRIPTION	SKETCH	QTY
a	ALLEN KEY	 5#	1PC
b	BOLT	 M8x25	32PCS
c	BOLT	 M8x50	12PCS
d	METAL CONNECTOR		4PCS
e	WASHER		44PCS

PARTS LIST:

NO	DESCRIPTION	SIZE(mm)	SKETCH	QTY
A	RIGHT SEATER	620*1450		1PC
B	CORNER BACK	620*620		1PC
C	LEFT SEATER	620*1080		1PC
D	LEG	610*330*60		3PCS



Step 1

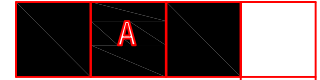

RIGHT FACING
CORNER NOOK

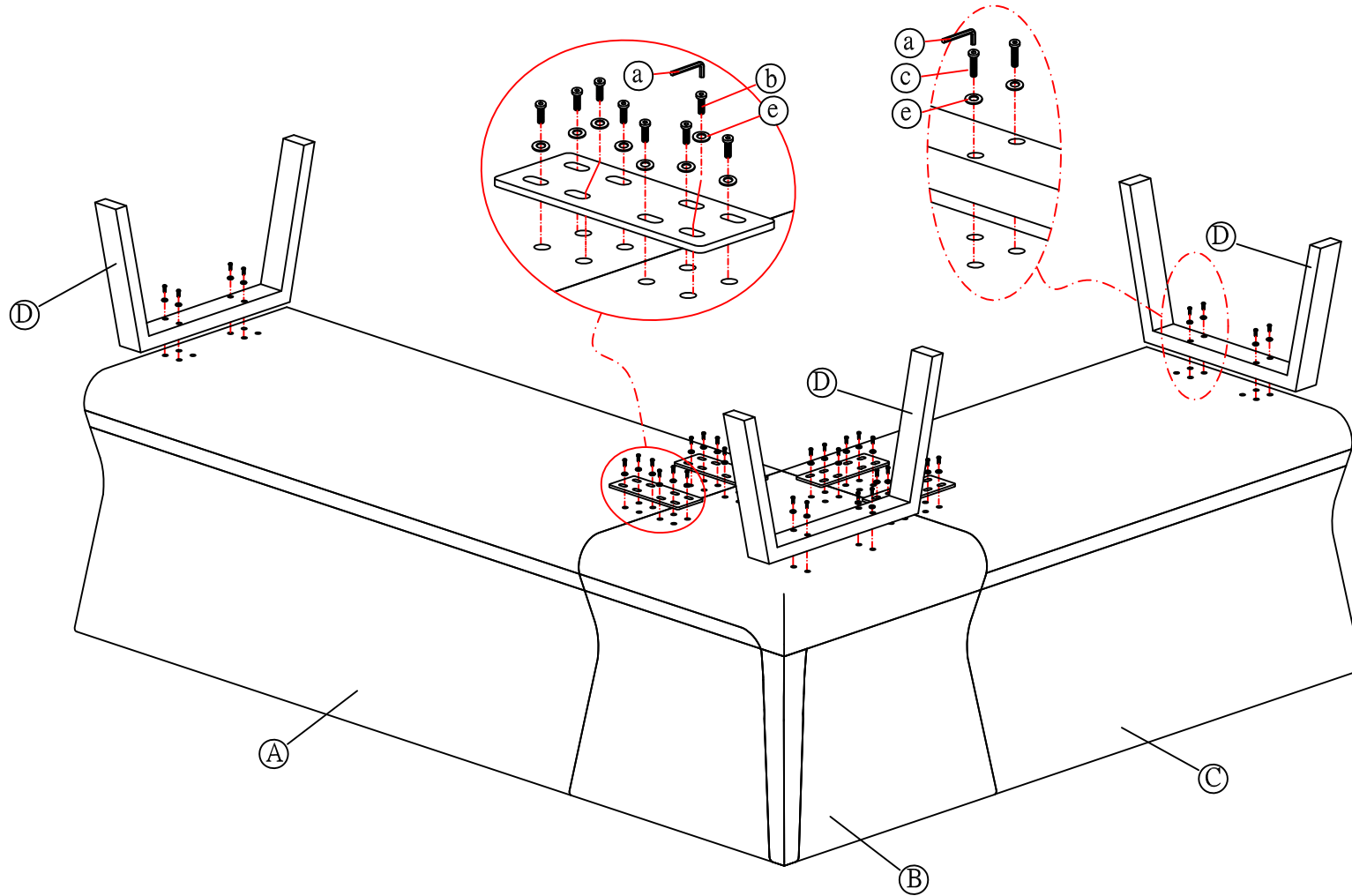



Step 1

