







THANK YOU FOR PURCHASING THIS QUALITY PRODUCT.

BE SURE TO CHECK ALL PACKING MATERIAL CAREFULLY FOR SMALL PARTS THAT MAY HAVE COME LOOSE INSIDE THE CARTON DURING TRANSIT.

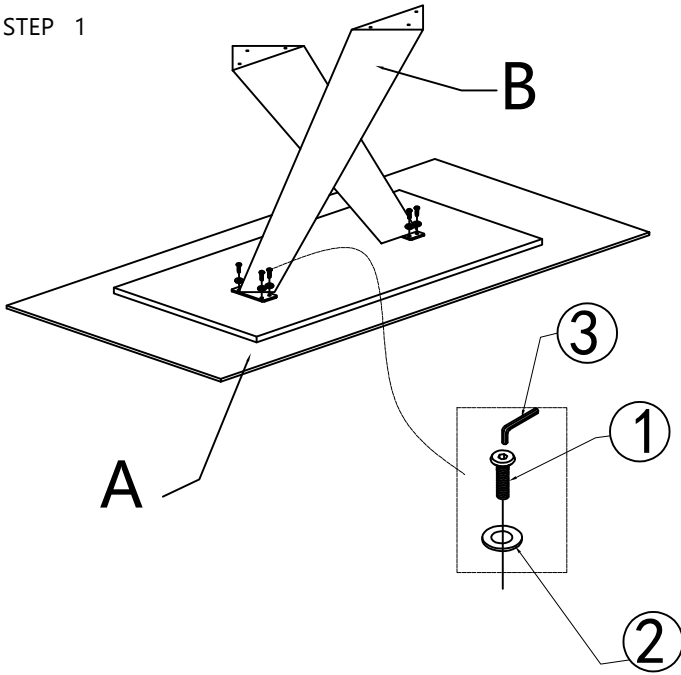
**PART LIST**

NO	DESC	SIZE (MM)	SKETCH	QTY
A				1PCS
B				2PCS
C				1PCS
D				
E				

**STEP 1**

**HARDWARE LIST**

NO	DESC	SIZE (MM)	SKETCH	QTY
1	BOLT	M8*16		8 PCS
2	GASKETS	Ø8.3		14 PCS
3	SPANNER	5MM		1PCS
4	BOLT	M8*35		6 PCS

