

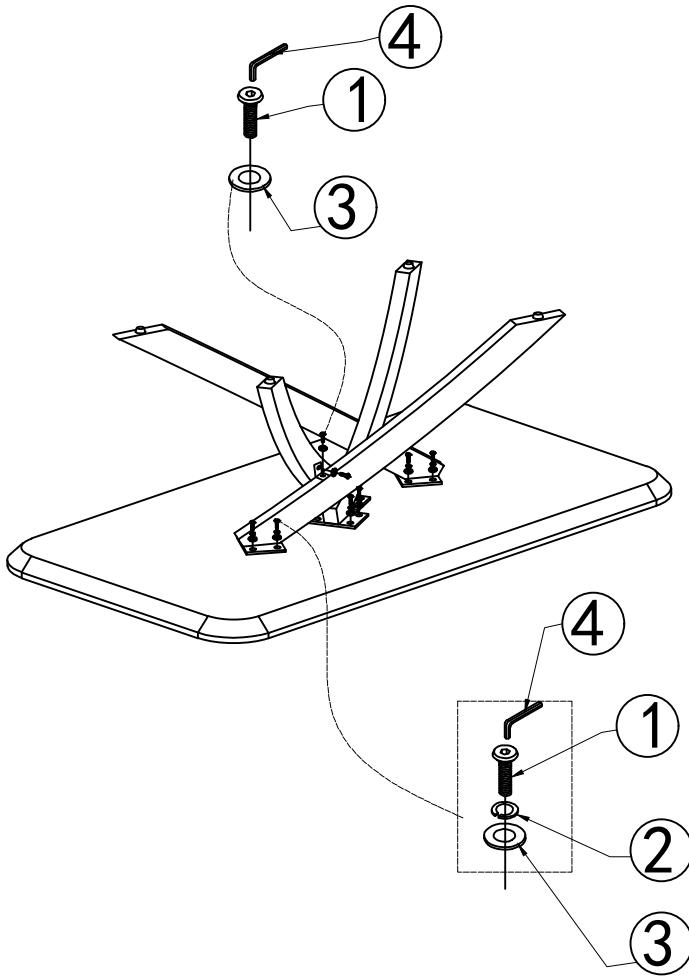

THANK YOU FOR PURCHASING THIS QUALITY PRODUCT.  
BE SURE TO CHECK ALL PACKING MATERIAL CAREFULLY FOR SMALL PARTS THAT MAY HAVE COME LOOSE INSIDE THE CARTON DURING TRANSIT.



PART LIST

NO	DESC	SIZE (MM)	SKETCH	QTY
A		1300X700X40		1PC
B				2PC
C				2PC

HARDWARE LIST

NO	DESC	SIZE(MM)	SKETCH	QTY
1	BOLT	M8x25		18PCS
2		ø8.3		14PCS
3	FLAT WASHER	ø8.3		18PCS
4	SPANNER	5MM		1PC
5				
6				

