

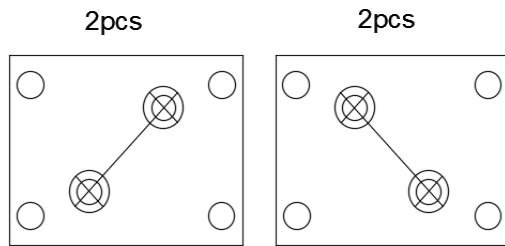



Thank you for purchasing this quality product. Be sure to check all packaging material carefully for small parts that may have come loose inside the carton during shipment.







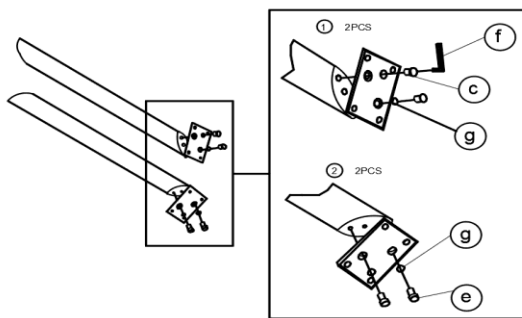

**Step 1**

**PARTS LIST:**

NO	DESCRIPTION	SIZE(mm)	SKETCH	QTY
A	Top	2100*900*95		1pc
B	Base	35*80*800		4pcs
C	Connection metal	110*80*6		4pcs

**Step 2**

Please assemble bolt "e", spring washer "g" into the sunk hole of the metal "C". The side with flat hole is close to the leg.

**HARDWARE LIST:**

NO	DESCRIPTION	SIZE(mm)	SKETCH	QTY
a	Gasket	Ø17*Ø8*1.0		16PCS
b	Spring gasket	Ø13*Ø9*2.0		16PCS
c	Cylinder head screw	M8*20		16PCS
d	Hex key	6mm		1PC
e	Cylinder head screw	M10*20		8PCS
f	Hex key	8mm		1PC
g	Spring gasket	Ø17*Ø11*2.0		8PCS
h	Wrench	M6		1PC

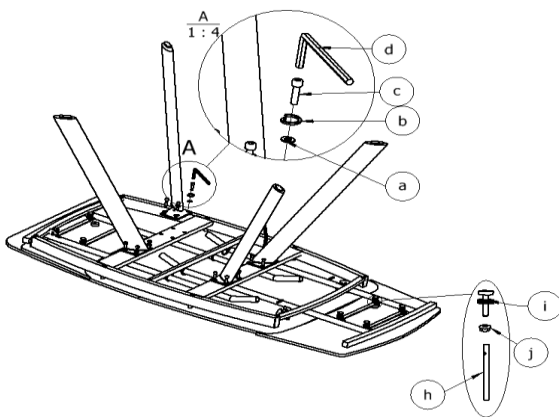
**Step 3**

If the glass are not aligned well, please use wrench "h" to loose the nut "j" and move the glass a little big left or right and make it align well,  
If the glass are not levelled well, please use wrench "h" to loose the nut "j" and turn the thrum wheel "i" to adjust the glass height

**Step 4**
