



THANK YOU FOR PURCHASING THIS QUALITY PRODUCT.

BE SURE TO CHECK ALL PACKING MATERIAL CAREFULLY FOR SMALL PARTS THAT MAY HAVE COME LOOSE INSIDE.

THE CARTON DURING TRANSIT.

STEP 1

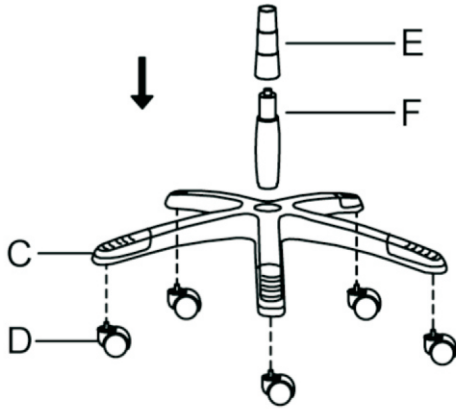

STEP 2

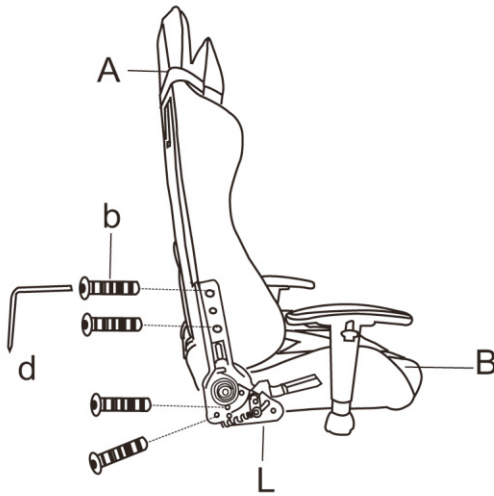

STEP 3

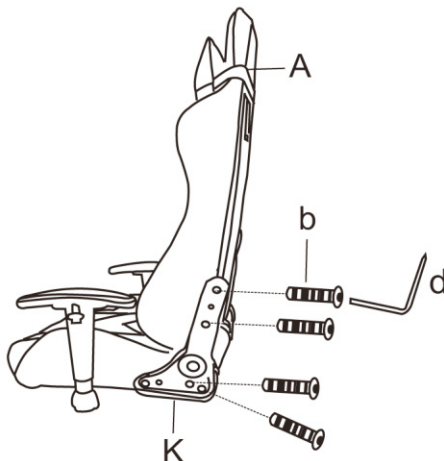

PART LIST

NO	DESC	SIZE (MM)	SKETCH	QTY
A	BACK	830X585 X165		1 PC
B	SEAT	550X500 X170		1 SET
	ARMREST	280X275 X225		
C	STARBASE	R350X100		1 PC
D	CASTORS	80X60X55		5 PCS
E	GASLIFT COVER	R30XL100		1 PC
F	GASLIFT	R25XL260		1 PC
G	RIGHT PLASTIC COVER	240X55X35		1 PC
H	LEFT PLASTIC COVER	250X55X35		1 PC
I	HEAD PILLOW	310X190X70		1 SET
	BACK PILLOW	320X200X70		
J	SWIVEL TRAY	350X280 X110		1 PC
K	RECLINE MECHANISM (L)	235X290		1 PC
L	RECLINE MECHANISM (R)	160X290		1 PC
M	PLASTIC COVER	180X130 X45		1 PC
N	PLASTIC COVER	180X115 X20		1 PC

HARDWARE LIST

NO	DESC	SIZE (MM)	SKETCH	QTY
a	SCREW	M5X12		4 PCS
b	SCREW	M8X20		20PCS
c	SCREW COVER	R9X8		4 PCS
d	SPANNER	M6		1 PC

MADE IN CHINA



THANK YOU FOR PURCHASING THIS QUALITY PRODUCT.

BE SURE TO CHECK ALL PACKING MATERIAL CAREFULLY FOR SMALL PARTS THAT MAY HAVE COME LOOSE INSIDE.

THE CARTON DURING TRANSIT.

STEP 4

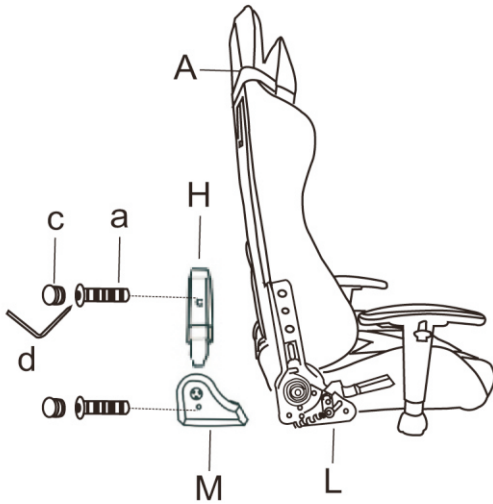

STEP 5

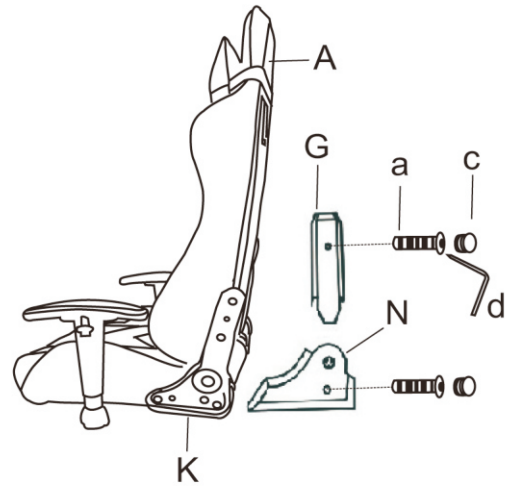

STEP 6

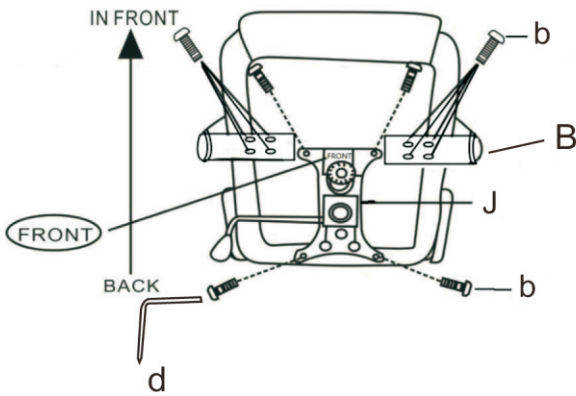

STEP 7

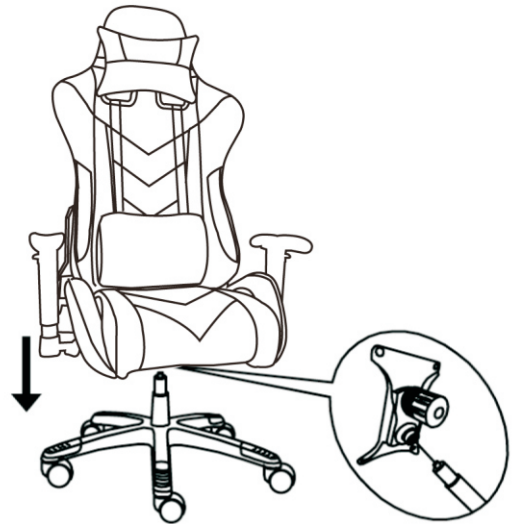

FINISH

