

Step 1

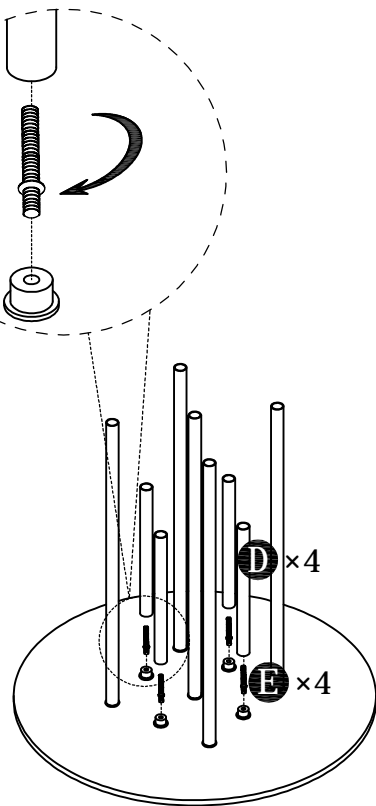

Step 2

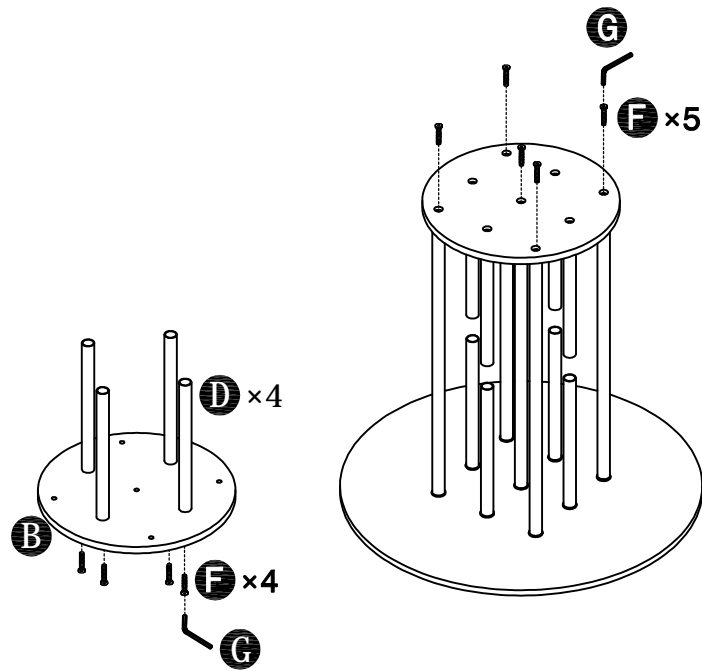





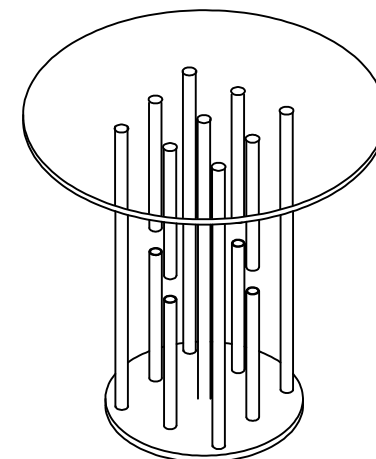

Step 3

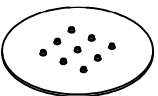
Step 4

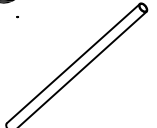

Step 5

<p>A</p>  <p>1 pc</p>	<p>B</p>  <p>1 pc</p>	<p>C</p>  <p>5 pcs</p>	<p>D</p>  <p>8 pcs</p>	<p>E</p>  <p>9 pcs</p>	<p>F</p>  <p>9 pcs</p>	<p>G</p>  <p>1 pc</p>		Item NO	
								Di mensi on	
								Assembly Instruction	