







BUTLER

Assembly Instructions
Style Number 3034146

SPECIALTY COMPANY
8200 SOUTH CHICAGO AVE., CHICAGO, IL 60617

PACKAGED

- | | |
|---|--|
| (A) 1-  1pc | (D) 4-  Ø5/16"X19mm FLAT WASHER 12pcs |
| (B) 2-  4pc | (E) 5-  Ø5/16" LOCK WASHER 12pcs |
| (C) 3-  2pcs | (F) 6-  Ø5/16"X2" ALLEN BOLTS 12pcs |
| (G) 7-  5MM ALLEN WRENCH 1pc | |

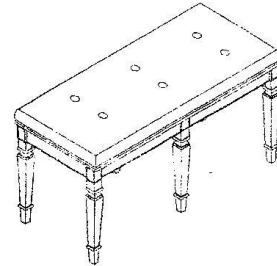

Read all instructions before starting assembly.

Step #1 Remove all the contents from the package checking that all of the components listed in "Packaged" are included. Prepare a flat, protected work surface where the product can be assembled.

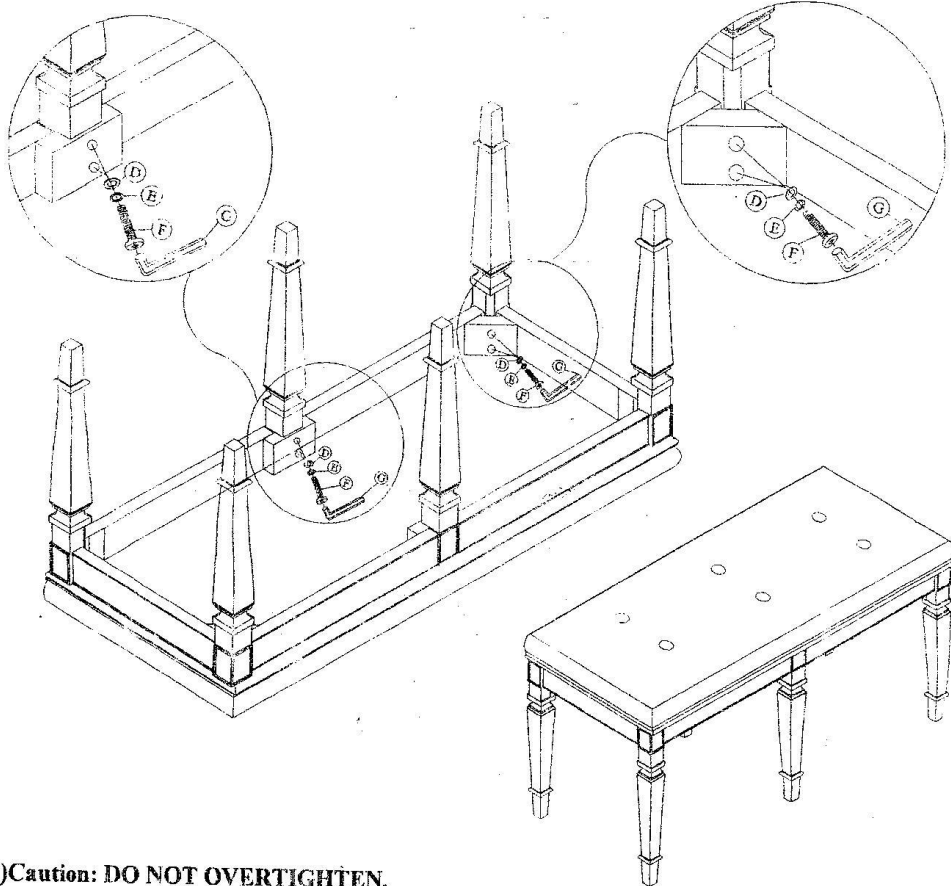

(*Caution: DO NOT OVERTIGHTEN.

In any correspondence regarding this product, please include the complete Butler identification number located on the underside of the product.

We hope this Bench will be a useful and decorative addition to your home for years to come.

Copyright Butler Specialty Company 04/10