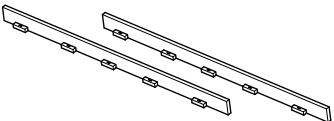
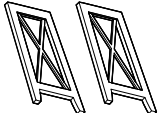
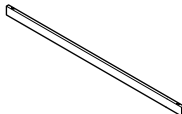
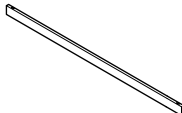

ASSEMBLY INSTRUCTION

MODEL: #5938DS-533 Table W/O Drop Leaf (V#12600CSES1)

**NOTE: THIS ITEM NOT RECOMMENDED FOR COMMERCIAL USE
KEEP THIS DOCUMENT FOR REFERENCE IN CASE PARTS ARE NEEDED
DO NOT TIGHTEN SCREWS UNTIL COMPLETELY ASSEMBLED**

HARDWARE LIST			
NO		DESCRIPTION	QTY
1		JCBC BOLT M6 x 30MM	14 PCS
2		JCBC BOLT M6 x 50MM	8 PCS
3		SPRING WASHER M6	22 PCS
4		FLAT WASHER M6 x 12MM	14 PCS
5		HALF-MOON WASHER M6	8 PCS
6		ALLEN KEY M4 x 110MM	1 PC

PART LIST			
NO		DESCRIPTION	QTY
A		TABLE TOP	1
B		TABLE FRAME	2
C		TABLE LEG (R/L)	2
D		CENTER BAR	1
E		BOTTOM BAR	1

ASSEMBLY INSTRUCTION

MODEL: #5938DS-533 Table W/O Drop Leaf (V#12600CSES1)

Step 1

Install Table Frame (B) to Table Top (A) as shown.
Tighten all hardware in this step.

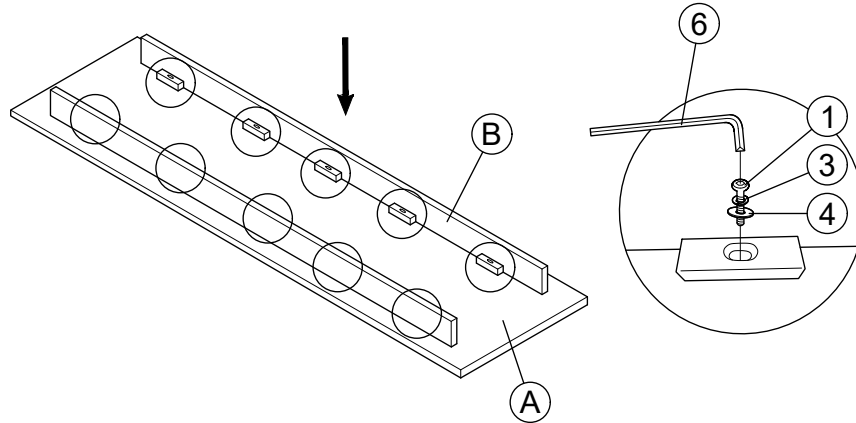

Step 2

Install Table Leg (C) - Left Side to the Table Top (A) and Table Frame (B) as shown below.
Tighten all hardware in this step.

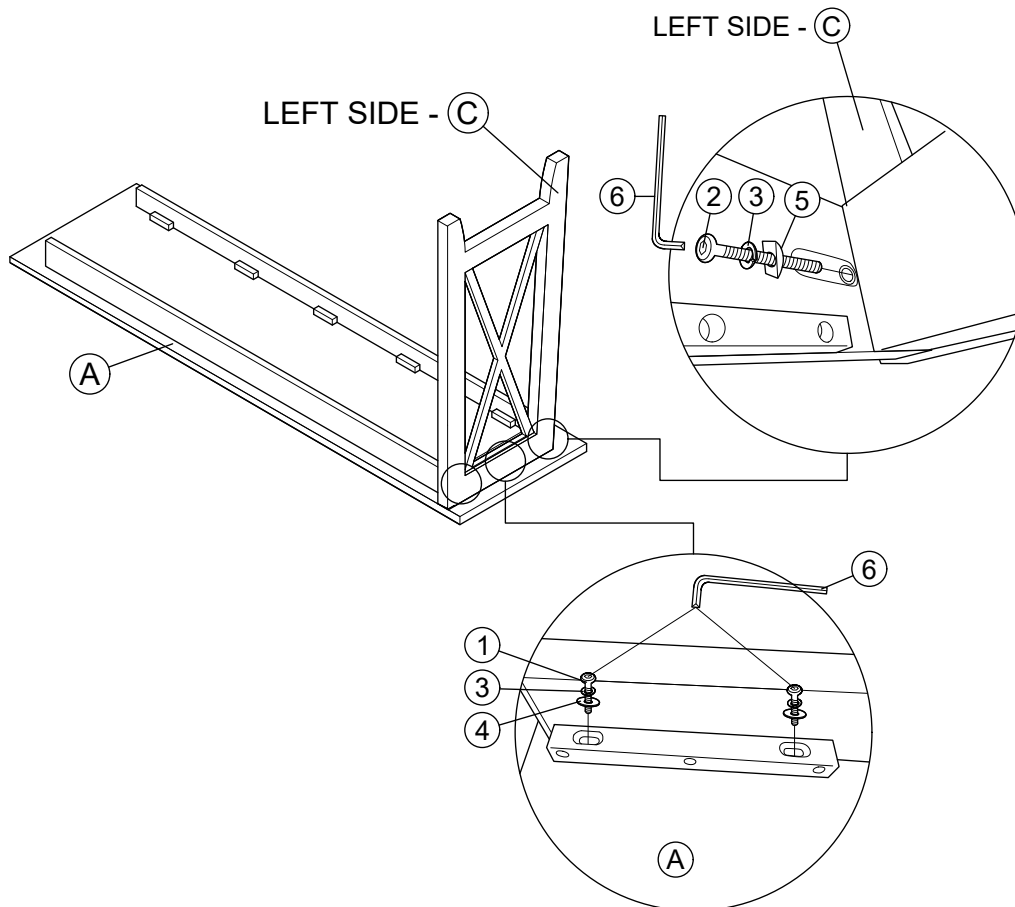

ASSEMBLY INSTRUCTION

MODEL: #5938DS-533 Table W/O Drop Leaf (V#12600CSES1)

Step 3

Install Center Bar (D) and Bottom Bar (E) as shown below.
Tighten all hardware in this step.

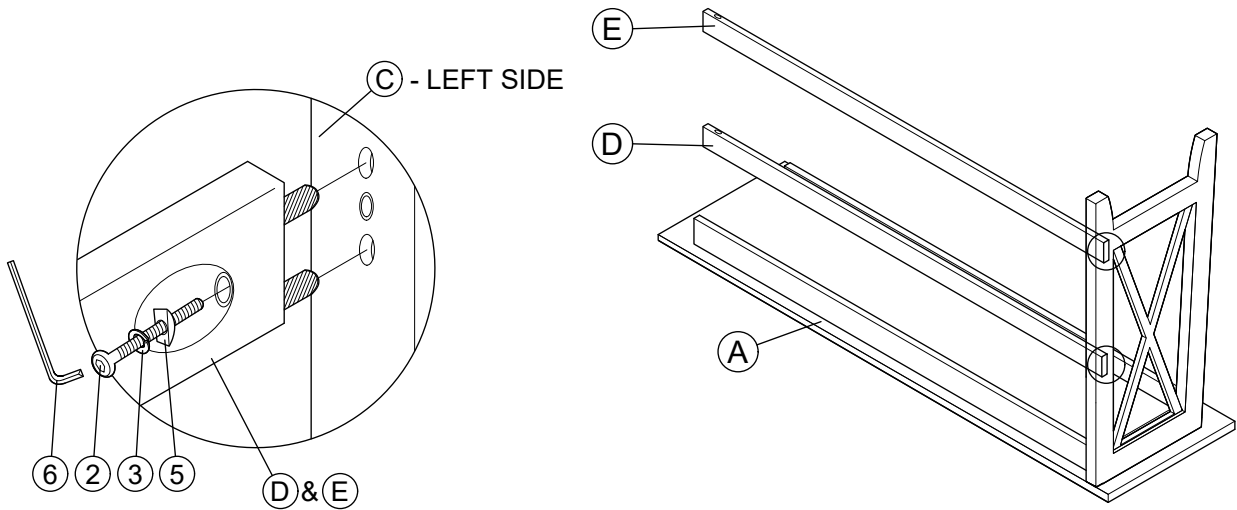

Step 4

Install another Table Leg (C) - Right Side to the Table Top (A) and Table Frame (B) as shown below.
Tighten all hardware in this step.

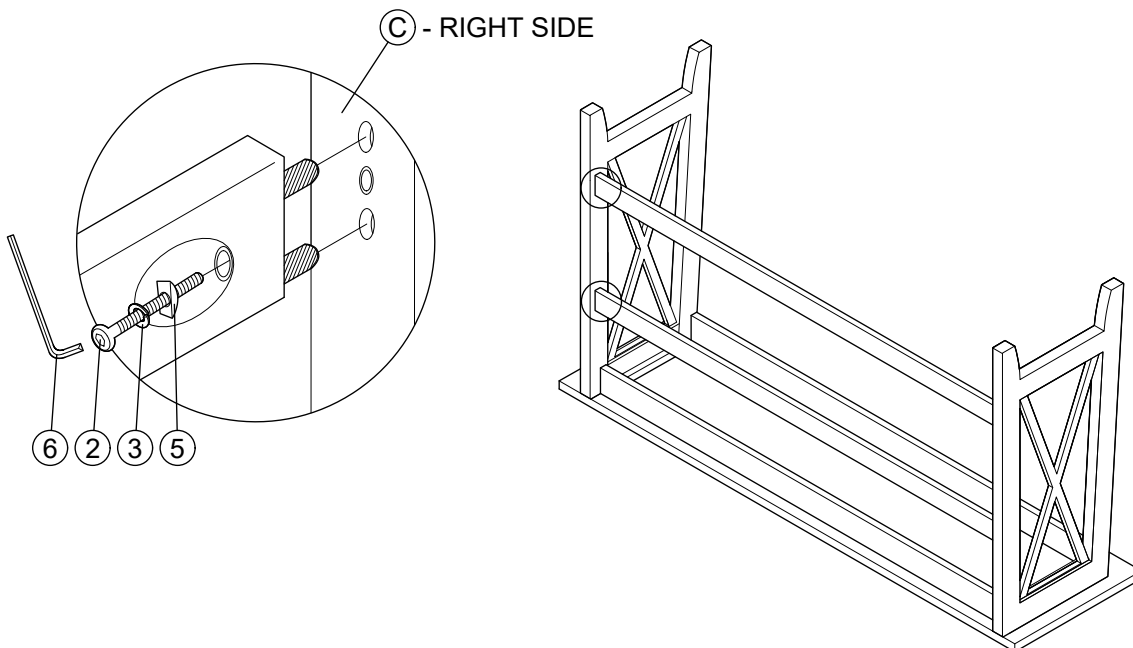

ASSEMBLY INSTRUCTION

MODEL: #5938DS-533 Table W/O Drop Leaf (V#12600CSES1)

Step 5
Tighten all hardware in this step.

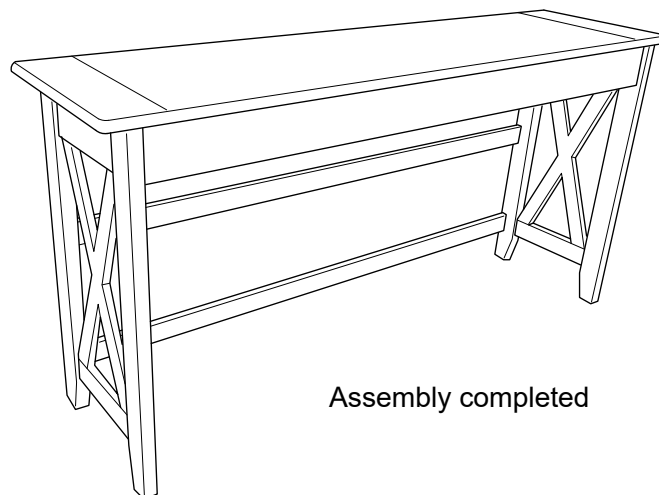
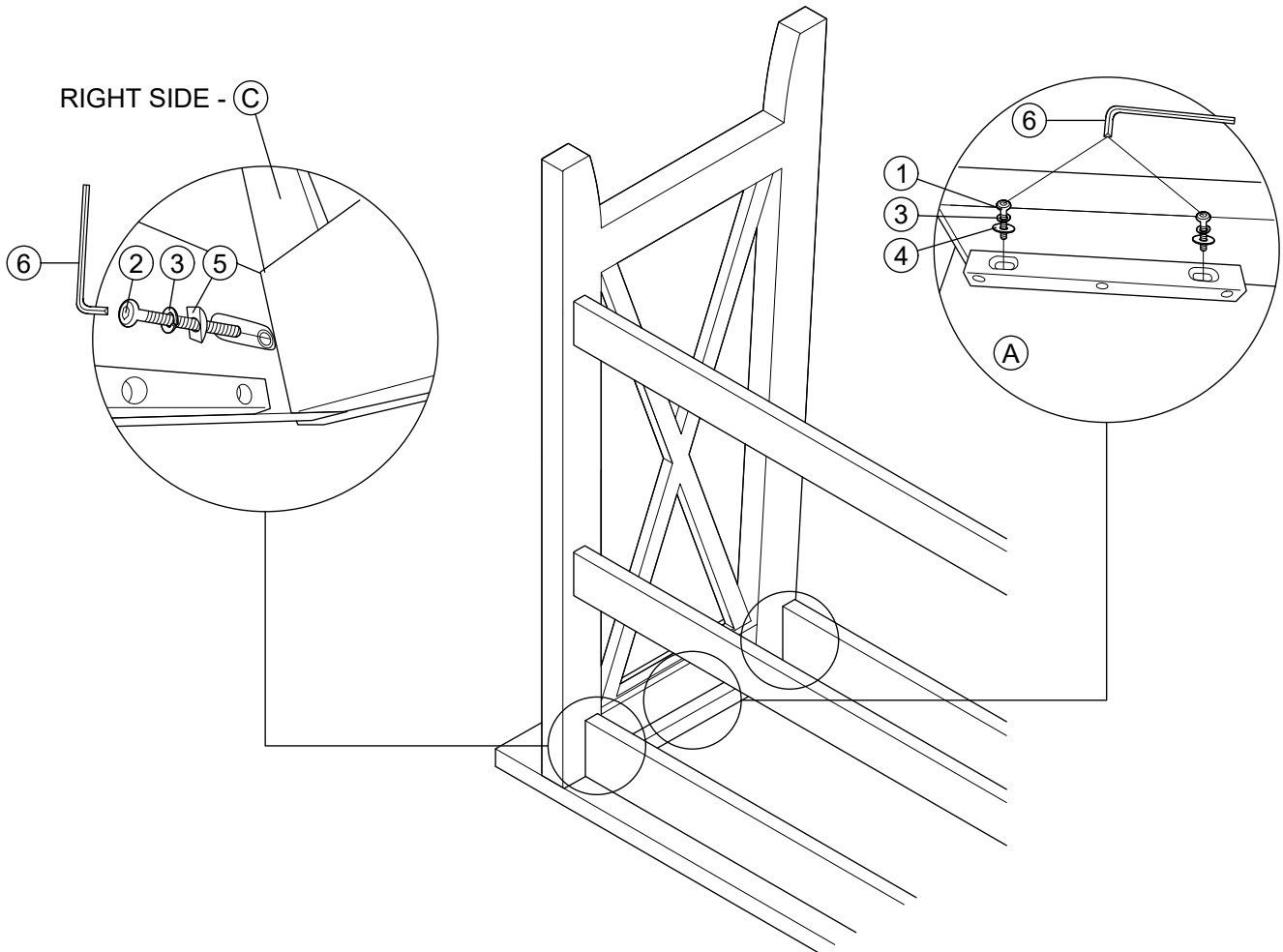

Assembly completed