











ASSEMBLY INSTRUCTIONS

MODEL # : 5674-530 TABLE (V#12600 SNFR1)

**NOTE: THIS ITEM NOT RECOMMENDED FOR COMMERCIAL USE
KEEP THIS DOCUMENT FOR REFERENCE IN CASE PARTS ARE NEEDED
DO NOT TIGHTEN SCREWS UNTIL COMPLETELY ASSEMBLED! !**

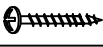
No	DESCRIPTION			Q'TY
A		TABLE TOP	40" x 40" x 3"	1PC
B		SHELF FRAME	18-1/4" x 18-1/4" x 2"	1PC
C		MOUNTING PANEL	35-1/4" x 2-3/8" x 3/4"	2PCS
D		CONNECTING FRAME	18-1/4" x 18-1/4" x 2"	1PC
E		TABLE LEG	34-5/8" x 2-1/8" x 2-1/8"	4PCS



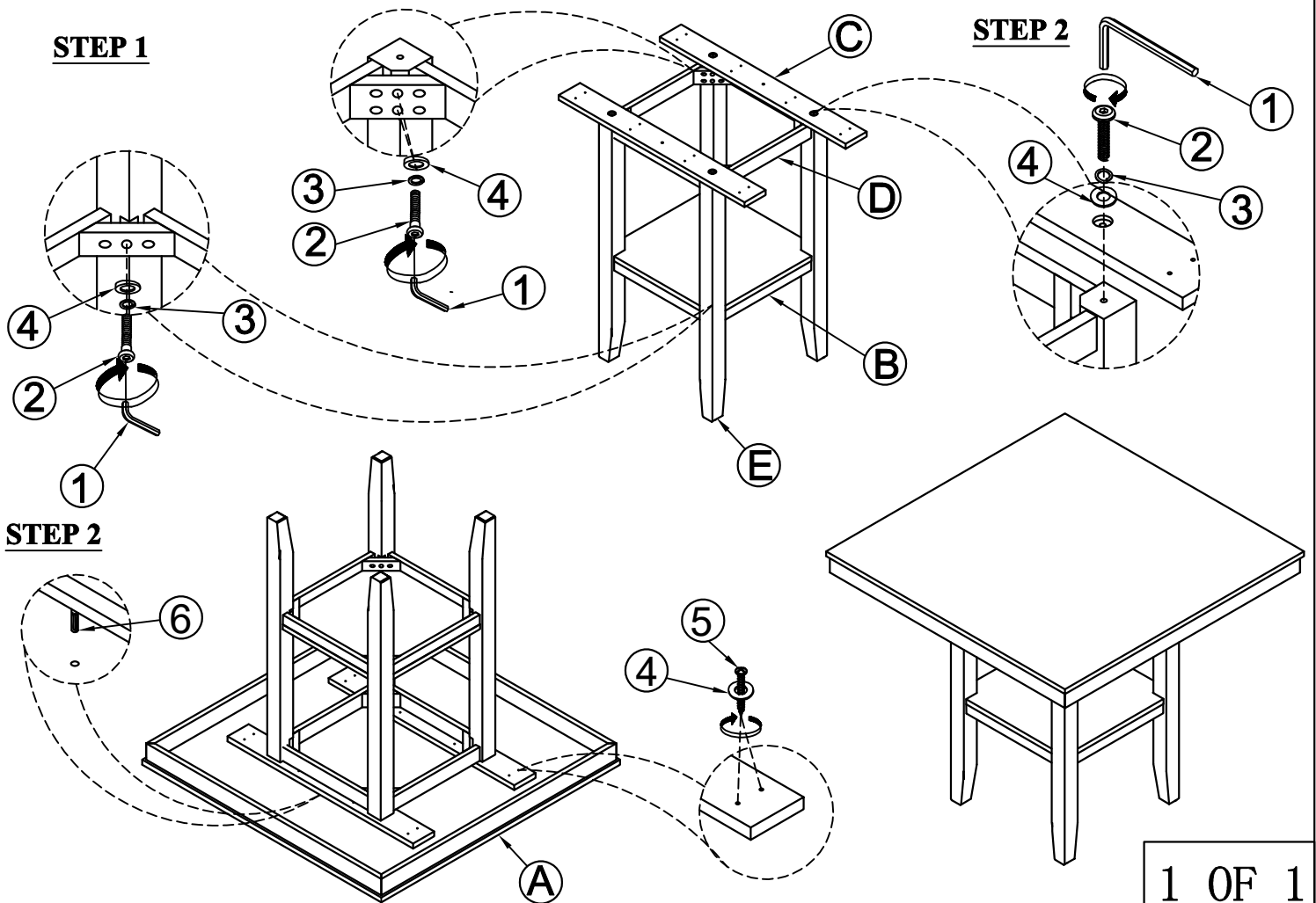



No	HARDWARE LIST			Q'TY
1		ALLEN KEY	4mm	1PC
2		BOLT	1/4" x 1-3/4"	16PCS
3		SPRING WASHER	Ø1/4" X 10D X 1.1mm	16PCS
4		FLAT WASHER	Ø1/4" X 19D X 2mm	32PCS
5		WOOD SCREW	M4 x 1-3/16"	16PCS
6		WOOD DOWEL	M8 x 3/4"	2PCS







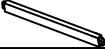

ASSEMBLY INSTRUCTIONS

MODEL # : 5674-530 CHAIR (V#12600 SNFR1)

**NOTE: THIS ITEM NOT RECOMMENDED FOR COMMERCIAL USE
KEEP THIS DOCUMENT FOR REFERENCE IN CASE PARTS ARE NEEDED
DO NOT TIGHTEN SCREWS UNTIL COMPLETELY ASSEMBLED!!**

No	PARTS LIST			Q'TY
A		CHAIR BACK	39"X16-1/2"X3-3/4"	1PC
B		SEAT FRAME	17"X16-1/2"X3/4"	1PC
C		LEFT LEG	23-1/4"X1-1/2"X1-1/2"	1PC
D		RIGHT LEG	23-1/4"X1-1/2"X1-1/2"	1PC
E		FRONT STRETCHER	13-1/2"X1-1/8"X3/4"	1PC
F		SIDE STRETCHER (RIGHT)	15-3/4"X1-1/8"X3/4"	1PC
G		SIDE STRETCHER (LEFT)	15-3/4"X1-1/8"X3/4"	1PC

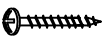
No	HARDWARE LIST			Q'TY
1		LONG BOLT	Ø1/4" x 3-1/8"	4PCS
2		SPRING WASHER	Ø1/4" X 10D X 1.1mm	10PCS
3		FLAT WASHER	Ø1/4" X 19D X 2mm	10PCS
4		ALLEN KEY	2-1/4" X 4mm	1PC
5		SHORT BOLT	Ø1/4" x 1-5/8"	2PCS
6		MEDIUM BOLT	Ø1/4" x 2-3/8"	4PCS
7		WOOD SCREW	M4 x1-1/2"	6PCS

STEP 1

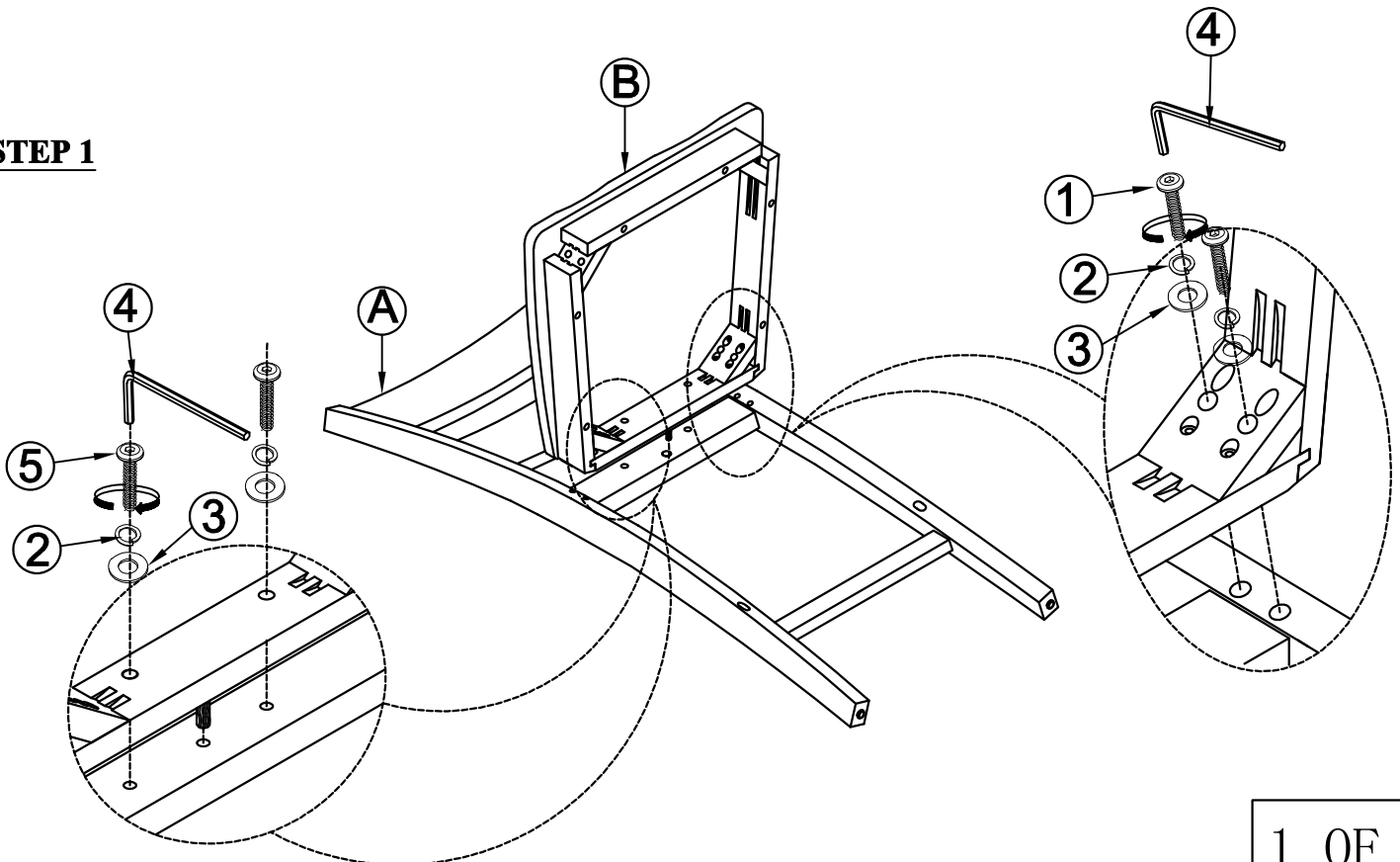

ASSEMBLY INSTRUCTIONS

MODEL # : 5674-530 CHAIR (V#12600 SNFR1)

NOTE: THIS ITEM NOT RECOMMENDED FOR COMMERCIAL USE
KEEP THIS DOCUMENT FOR REFERENCE IN CASE PARTS ARE NEEDED
DO NOT TIGHTEN SCREWS UNTIL COMPLETELY ASSEMBLED!!

STEP 2

