

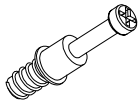
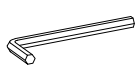
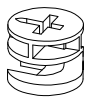

ASSEMBLY INSTRUCTION

MODEL: #405-715 CAPPUCCINO DESK (V#12600MCHA1)

**NOTE: THIS ITEM NOT RECOMMENDED FOR COMMERCIAL USE
KEEP THIS DOCUMENT FOR REFERENCE IN CASE PARTS ARE NEEDED
DO NOT TIGHTEN SCREWS UNTIL COMPLETELY ASSEMBLED**

HARDWARE LIST

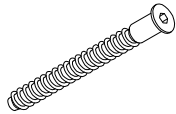
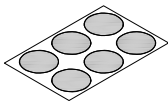
NO	ITEM	DESCRIPTION	QTY	NO	ITEM	DESCRIPTION	QTY
1		CAM BOLT ø7x35.5mm	8 PCS	4		ALLEN WRENCH 4mm	1 PC
2		CAM LOCK ø15x12mm	8 PCS	5		PLASTIC FEET ø15mm	8 PCS
3		BOLT ø7x70mm	32 PCS	6		STICKER ø20mm	7 PCS

PART LIST

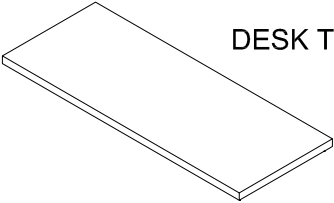
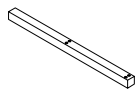
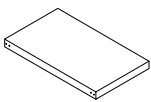
NO	ITEM	DESCRIPTION	QTY	NO	ITEM	DESCRIPTION	QTY
A		DESK TOP	1 PC	C		DESK LEG	8 PCS
B		SHELF	4 PCS				

ASSEMBLY INSTRUCTION

MODEL: #405-715 CAPPUCCINO DESK (V#12600MCHA1)

Step 1

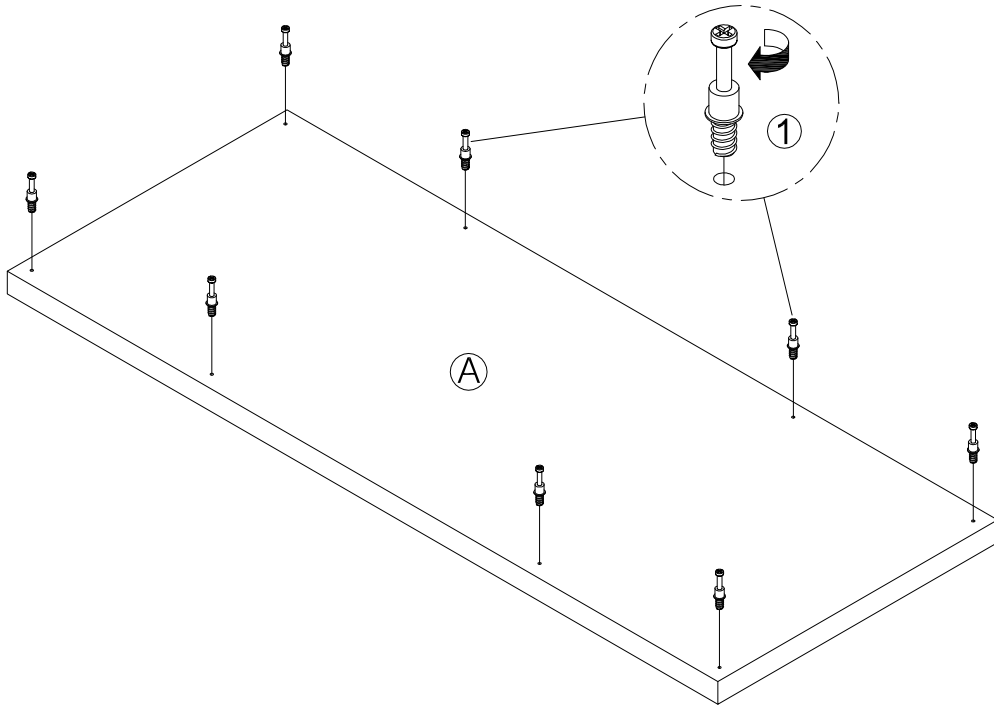
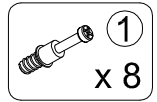

Step 2

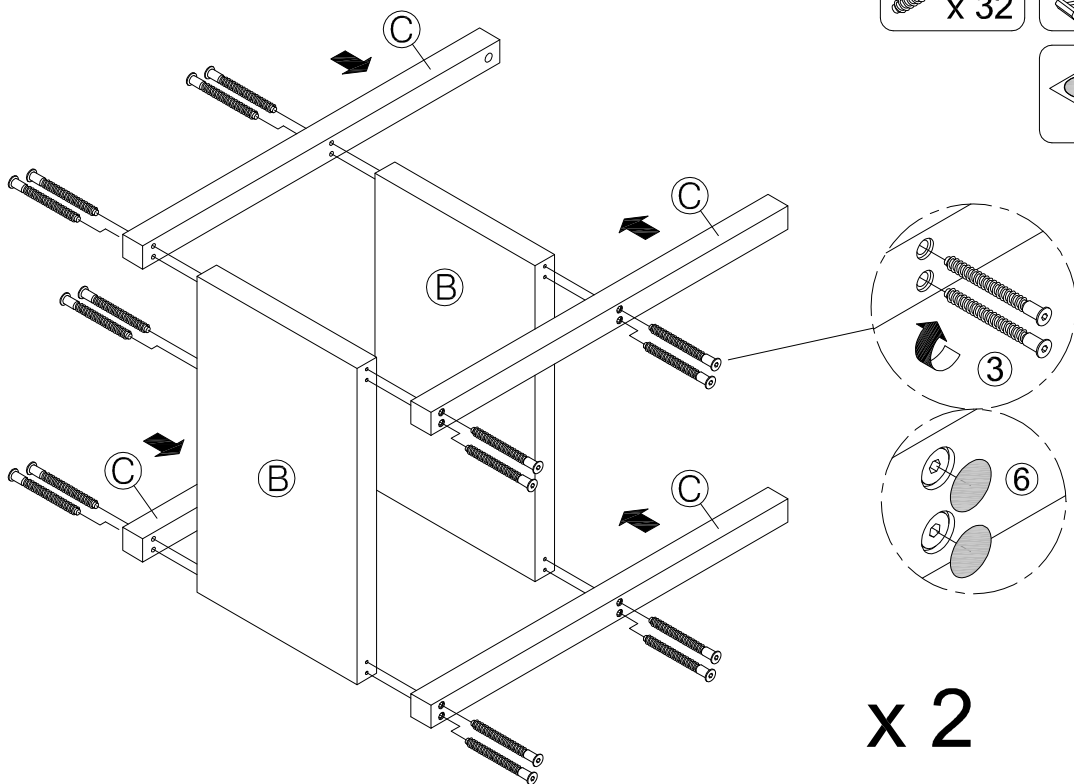
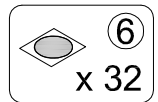
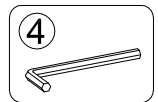
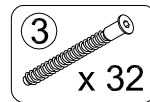

ASSEMBLY INSTRUCTION

MODEL: #405-715 CAPPUCCINO DESK (V#12600MCHA1)

Step 3

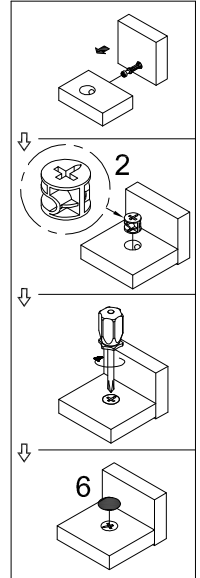
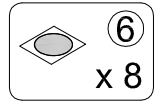
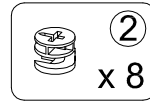
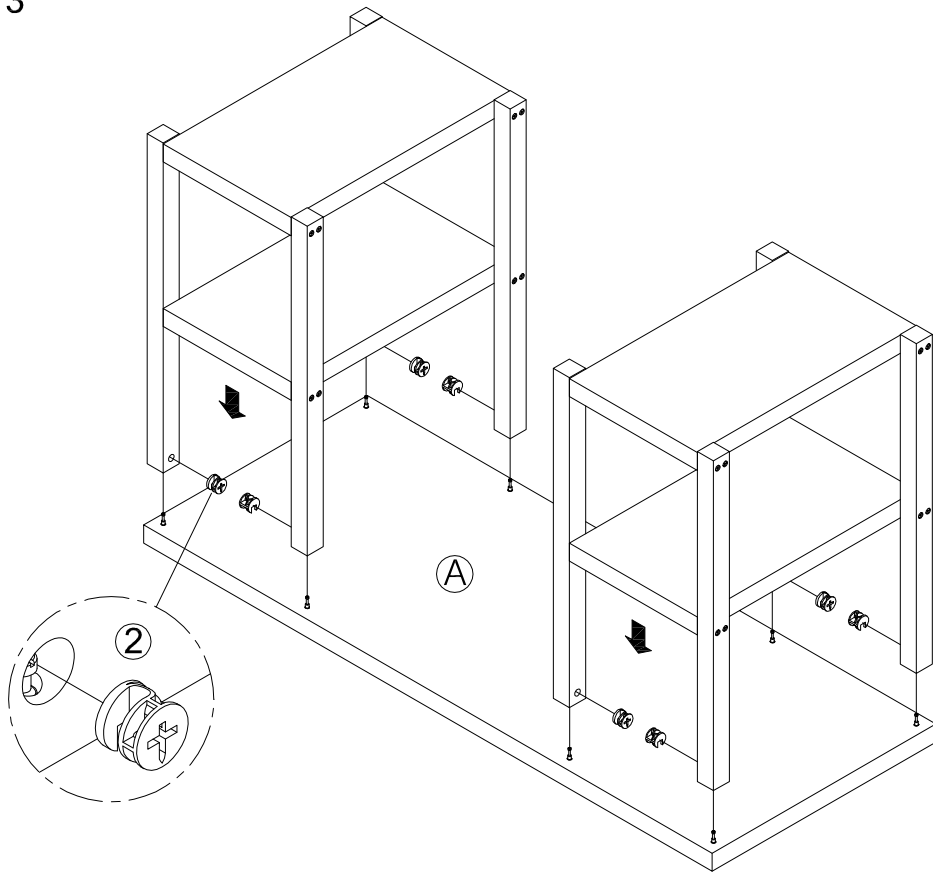

Step 4

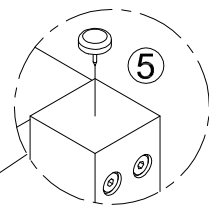
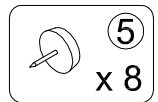
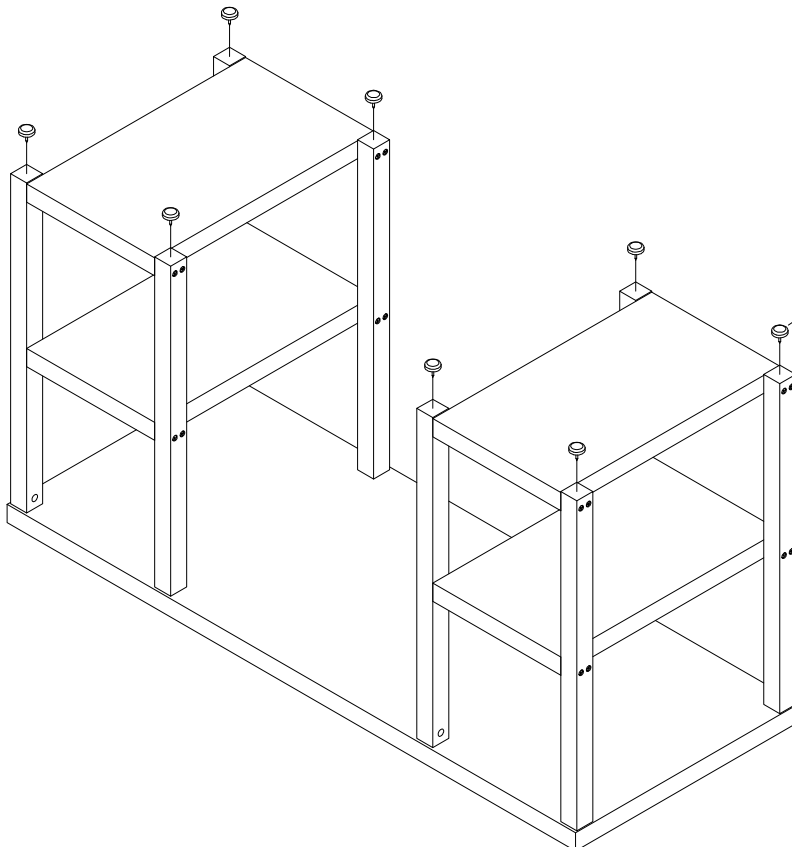

ASSEMBLY INSTRUCTION

MODEL: #405-715 CAPPUCCINO DESK (V#12600MCHA1)

Step 5

COMPLETER

