

ASSEMBLY INSTRUCTIONS

MODEL # : 388-002 END TABLE

(V#12600EWGL)

**NOTE: KEEP THIS DOCUMENT FOR REFERENCE IN CASE PARTS ARE NEEDED
DO NOT TIGHTEN SCREWS UNTIL COMPLETELY ASSEMBLED!!
UNIT SHOULD BE ASSEMBLED BY TWO OR MORE PEOPLE.**

- Always use proper tools.
- Follow the assembly steps in order. Do not skip any steps.
- Be sure to check all packing materials carefully for small parts may have come loose inside the carton during shipment. If parts are missing, contact the retailer from which you purchased the product to obtain any missing parts. **DO NOT USE SUBSTITUTE PARTS.**
- Periodically check to ensure that all connectors (bolts, screws, etc.) are tight.
- Keep the instructions for future reference.
- Some assembly may involve attaching glass or mirrors. Be very careful handling the glass or mirrors, as severe injury may result if the glass or mirror breaks. Never handle large pieces of glass or mirrors by yourself.
- When assembling products that have electric cords (lamps, light, etc.), always (1) make sure the electrical cord is unplugged before assembly and (2) be careful not to twist the electrical cord during assembly.
- When assembling shelves or entertainment centers, do not stand on lower shelves in order to assemble upper shelves-use a step ladder.
- Do not stand on tables, sit on tables and lay down on tables, including but not limited to, end tables, coffee tables, dinner tables as tables are not to support the weight of a person.
- Where assembly instructions state that the assembly requires two or more people, do not attempt by yourself as there is a risk of injury.
- Note : signature design furniture, llc. disclaims any liability for damages or injuries which may occur due to failure to properly follow assembly instructions, properly assemble the product, or properly use the product.
- For Stone and/or Wood care, only a minimal amount of mild detergent on lightly damp cloth should be used for cleaning. Spills should be wiped immediately as to not cause permanent damage or stains. Avoid placing hot items on any surface as this can cause permanent damage.

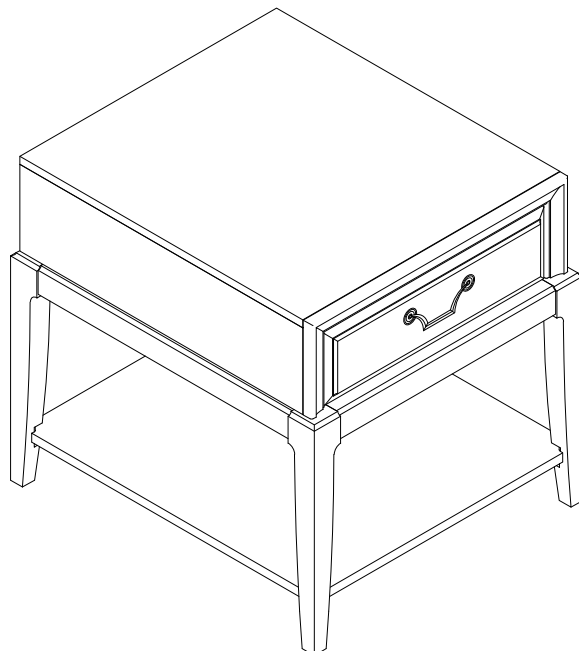









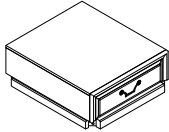

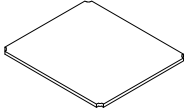
ASSEMBLY INSTRUCTIONS

MODEL # : 388-002 END TABLE

(V#12600EWGL)

NOTE: KEEP THIS DOCUMENT FOR REFERENCE IN CASE PARTS ARE NEEDED
DO NOT TIGHTEN SCREWS UNTIL COMPLETELY ASSEMBLED!!
UNIT SHOULD BE ASSEMBLED BY TWO OR MORE PEOPLE.

No	PART LIST		Q'TY
A		BODY CABINET	1PC
B		TABLE LEG	4PCS
C		BOTTOM SHELF	1PC

No	HARDWARE LIST			Q'TY
1		FLAT WASHER	$\varnothing 1/4 \times 19 \times 1.5\text{mm}$	8PCS
2		LOCK WASHER	$\varnothing 1/4 \times 13 \times 1\text{mm}$	16PCS
3		ALLEN BOLT	$\varnothing 1/4 \times 1-3/4"$	8PCS
4		FLAT WASHER	$\varnothing 1/4 \times 16 \times 1.5\text{mm}$	8PCS
5		ALLEN BOLT	$\varnothing 1/4 \times 5/8"$	8PCS
6		ALLEN KEY	$2-3/8 \times 4\text{mm}$	1PC
7		METAL "L"	$1-1/4" \times 3/4" \times 2\text{mm}$	4PCS

ASSEMBLY INSTRUCTIONS

MODEL # : 388-002 END TABLE

(V#12600EWGL)

NOTE: KEEP THIS DOCUMENT FOR REFERENCE IN CASE PARTS ARE NEEDED
DO NOT TIGHTEN SCREWS UNTIL COMPLETELY ASSEMBLED!!
UNIT SHOULD BE ASSEMBLED BY TWO OR MORE PEOPLE.

