

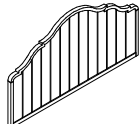

ASSEMBLY INSTRUCTIONS

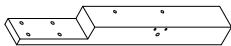

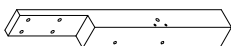

| | | |
|----------------------------|-----------------------------|----------------------|
| MODEL # : 338-110HK | KING PANEL HEADBOARD | (V#12600HMVY) |
| MODEL # : 338-110FK | KING PANEL FOOTBOARD | (V#12600HMVY) |
| MODEL # : 338-105RL | QUEEN/KING RAILS | (V#12600HMVY) |

NOTE: KEEP THIS DOCUMENT FOR REFERENCE IN CASE PARTS ARE NEEDED
DO NOT TIGHTEN SCREWS UNTIL COMPLETELY ASSEMBLED!!
UNIT SHOULD BE ASSEMBLED BY TWO OR MORE PEOPLE.

PART LIST OF #338-110HK KING PANEL HEADBOARD

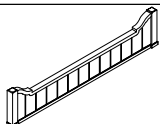
| <u>No</u> | | DESCRIPTION | Q'TY |
|-----------|--|-----------------------|------|
| A |  | HEADBOARD | 1PC |
| B |  | HEADBOARD LEG (L) | 1PC |
| C |  | HEADBOARD LEG (R) | 1PC |
| D |  | HEADBOARD BOTTOM RAIL | 1PC |

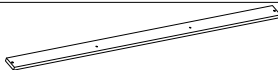
PART LIST OF #338-110FK KING PANEL FOOTBOARD

| <u>No</u> | | DESCRIPTION | Q'TY |
|-----------|---|---------------------------|-------|
| E |  | FOOTBOARD | 1PC |
| F |  | FOOTBOARD LEGS | 2PCS |
| G |  | SLATS | 5PCS |
| H |  | SUPPORT LEGS WITH LEVELER | 10PCS |

PART LIST OF #338-105RL QUEEN/KING RAILS

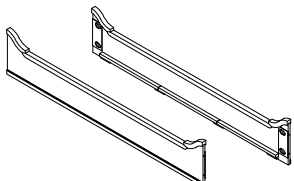
| <u>No</u> | | DESCRIPTION | Q'TY |
|-----------|---|-------------|------|
| I |  | SIDE RAIL | 2PCS |









ASSEMBLY INSTRUCTIONS

MODEL # : 338-110HK KING PANEL HEADBOARD (V#12600HMVY)
MODEL # : 338-110FK KING PANEL FOOTBOARD (V#12600HMVY)
MODEL # : 338-105RL QUEEN/KING RAILS (V#12600HMVY)

NOTE: KEEP THIS DOCUMENT FOR REFERENCE IN CASE PARTS ARE NEEDED
DO NOT TIGHTEN SCREWS UNTIL COMPLETELY ASSEMBLED!!

UNIT SHOULD BE ASSEMBLED BY TWO OR MORE PEOPLE.

HARDWARE LIST OF #338-110HK KING PANEL HEADBOARD

| No | | DESCRIPTION | | Q'TY |
|----|--|----------------|--------------------|-------|
| 1 |  | FLAT WASHER | ø5/16 x 19 x 1.5mm | 10PCS |
| 2 |  | LOCK WASHER | ø5/16 x 13 x 1mm | 10PCS |
| 3 |  | ALLEN BOLT | ø5/16 x 1-3/4" | 10PCS |
| 4 |  | ALLEN KEY | 2-3/8" x 4mm | 1PC |
| 5 |  | THREAD BOLT | ø5/16 x 90mm | 8PCS |
| 6 |  | CURVED WASHERS | ø5/16 x DIA | 8PCS |
| 7 |  | HEX NUT | ø5/16 x DIA | 8PCS |
| 8 |  | OPEN WRENCH | 12mm | 1PC |

HARDWARE LIST OF #338-110FK KING PANEL FOOTBOARD

| No | | DESCRIPTION | | Q'TY |
|----|---|-------------|--------------|-------|
| 9 |  | SCREW | 1-1/4" x 4mm | 10PCS |

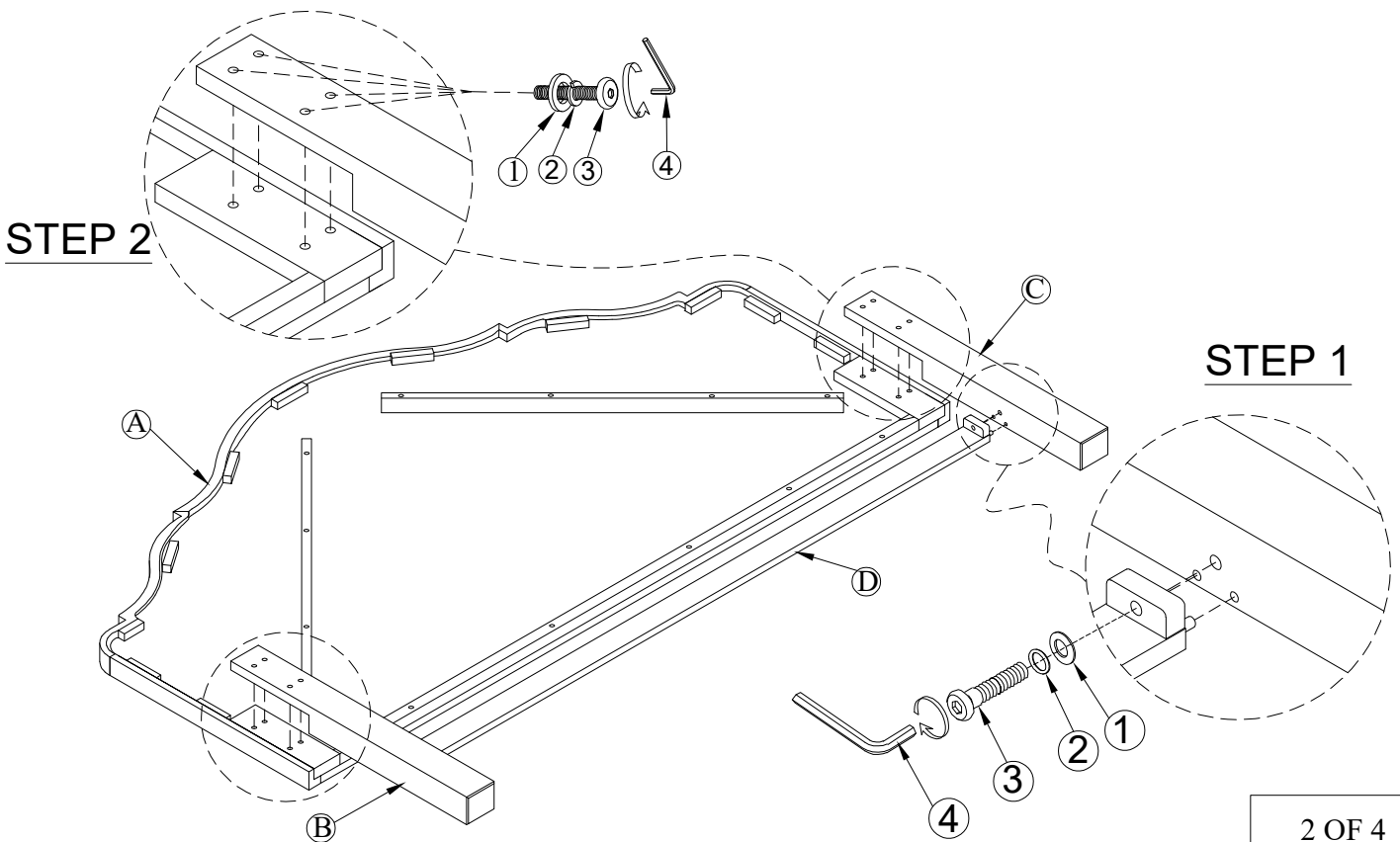

ASSEMBLY INSTRUCTIONS

MODEL # : 338-110HK KING PANEL HEADBOARD (V#12600HMVY)
MODEL # : 338-110FK KING PANEL FOOTBOARD (V#12600HMVY)
MODEL # : 338-105RL QUEEN/KING RAILS (V#12600HMVY)

NOTE: KEEP THIS DOCUMENT FOR REFERENCE IN CASE PARTS ARE NEEDED
DO NOT TIGHTEN SCREWS UNTIL COMPLETELY ASSEMBLED!!
UNIT SHOULD BE ASSEMBLED BY TWO OR MORE PEOPLE.

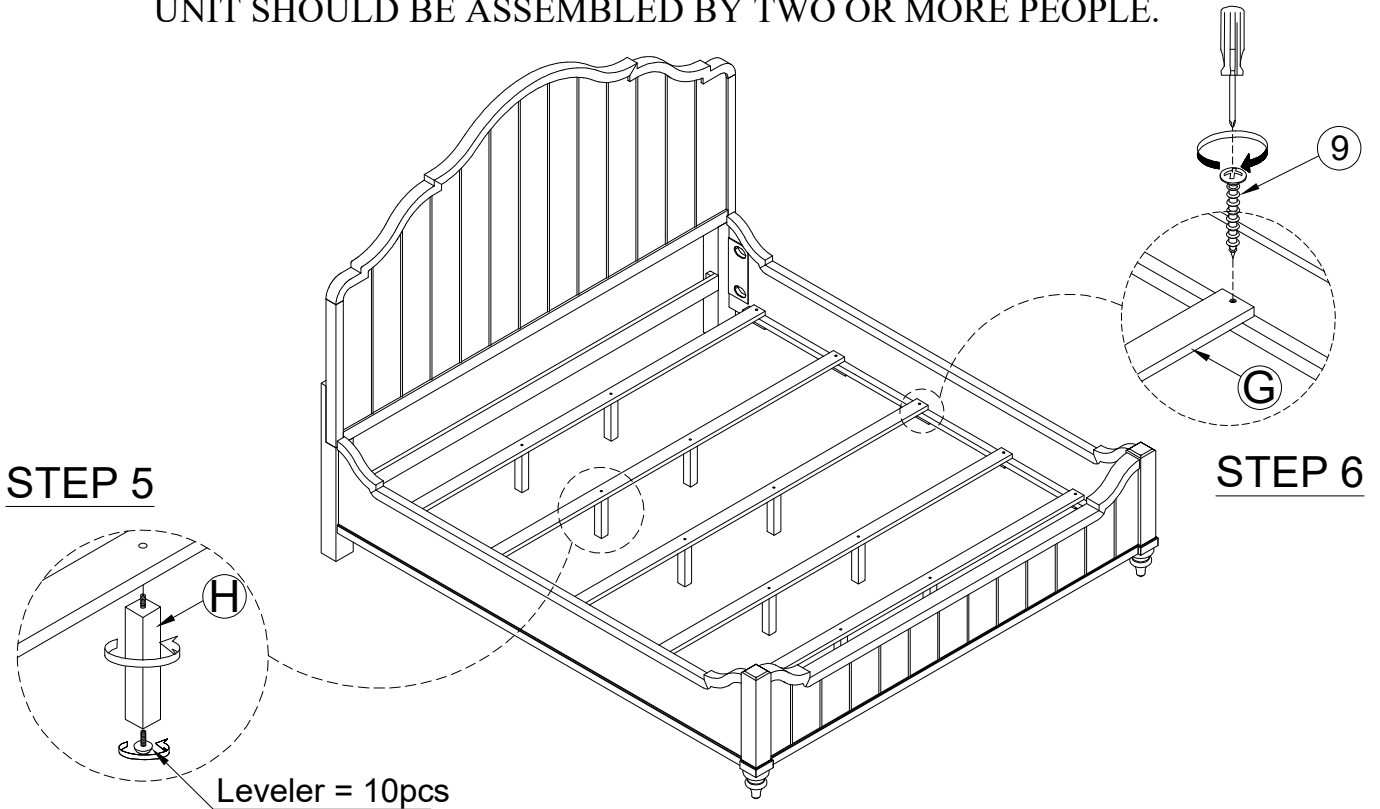

COMPLETED

