















ASSEMBLY INSTRUCTIONS

MODEL # : 315-110HK DANVILLE KING PANEL HB (V#12600VTC1)
MODEL # : 315-110FK DANVILLE KING PANEL FB (V#12600VTC1)
MODEL # : 315-105 RL DANVILLE QUEEN/ KING RAILS (V#12600VTC1)

NOTE: THIS ITEM NOT RECOMMENDED FOR COMMERCIAL USE
KEEP THIS DOCUMENT FOR REFERENCE IN CASE PARTS ARE NEEDED
DO NOT TIGHTEN SCREWS UNTIL COMPLETELY ASSEMBLED! !

No	PARTS LIST		Q'TY
A		HEADBOARD	1PC
B		LEFT LEG	1PC
C		RIGHT LEG	1PC
D		HEADBOARD BOTTOM RAIL	1PC
E		FOOTBOARD	1PC
F		SIDE RAIL	2PCS
G		SLATS	4PCS
H		SUPPORT LEGS WITH LEVELER	8PCS

No	HARDWARE LIST			Q'TY
1		BOLT	Ø5/16" x 1"	6PCS
2		LOCK WASHER	Ø5/16" x 10D x 1.1mm	6PCS
3		FLAT WASHER	Ø5/16" x 18D x 2mm	6PCS
4		WRENCH	4mm	1PC
5		SCREW	#4 x 1/2"	4PCS
6		SCREW	#4 x 1-1/4"	8PCS

STEP 1

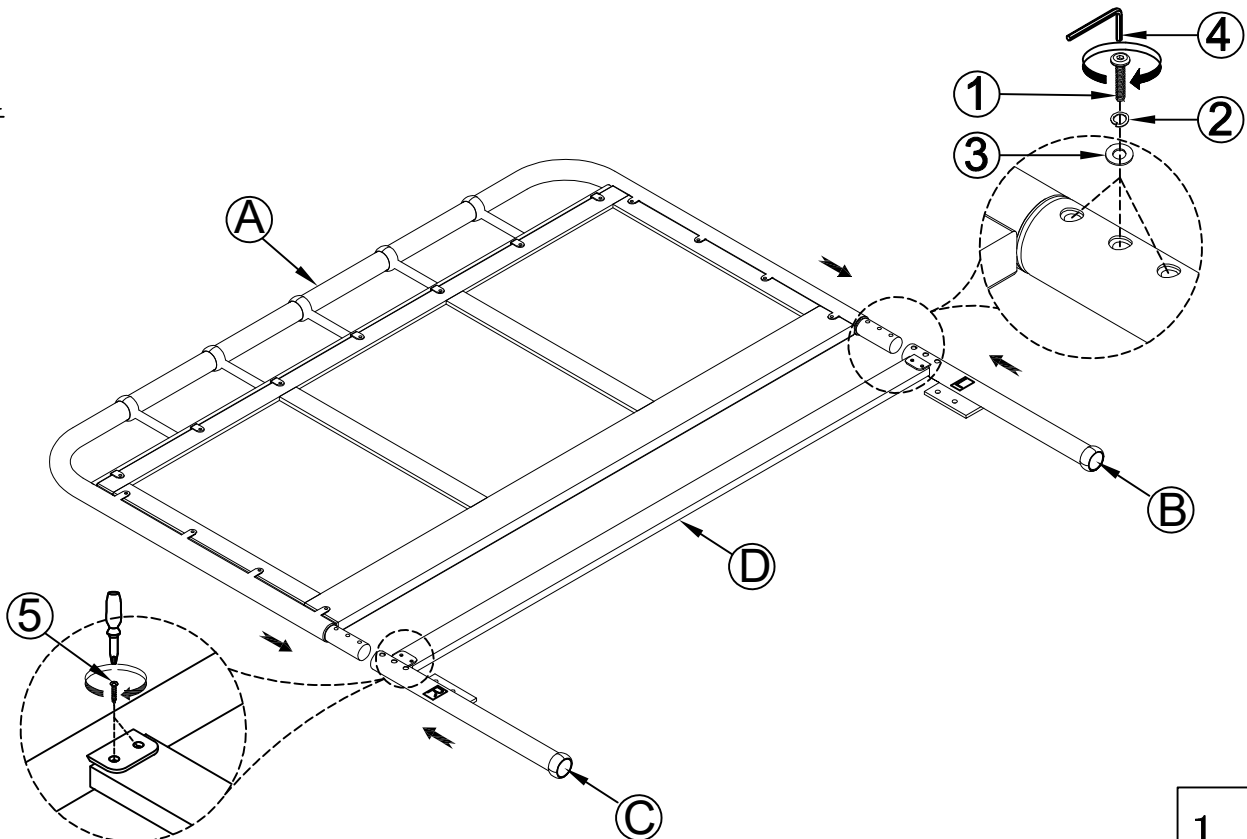

ASSEMBLY INSTRUCTIONS

MODEL # : 315-110HK DANVILLE KING PANEL HB (V#12600VTC1)
MODEL # : 315-110FK DANVILLE KING PANEL FB (V#12600VTC1)
MODEL # : 315-105 RL DANVILLE QUEEN/ KING RAILS (V#12600VTC1)

NOTE: THIS ITEM NOT RECOMMENDED FOR COMMERCIAL USE
KEEP THIS DOCUMENT FOR REFERENCE IN CASE PARTS ARE NEEDED
DO NOT TIGHTEN SCREWS UNTIL COMPLETELY ASSEMBLED! !

STEP 2

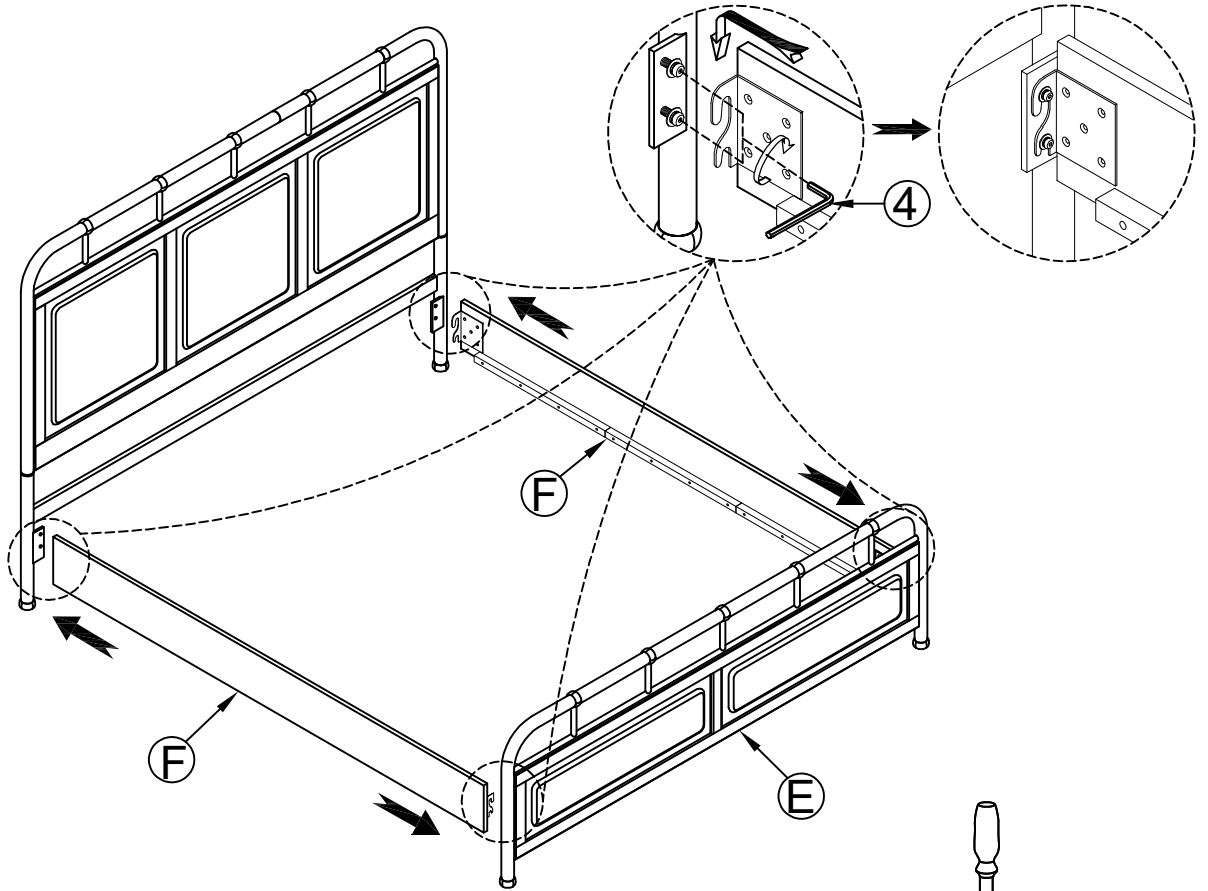

STEP 3

