



# ASSEMBLY INSTRUCTIONS

MODEL : #1508-105 (V#12600CF SB1)

**NOTE : THIS ITEM NOT RECOMMENDED FOR COMMERCIAL USE  
KEEP THIS DOCUMENT FOR REFERENCE IN CASE PARTS ARE NEEDED**

**DO NOT TIGHTEN SCREWS UNTIL COMPLETELY ASSEMBLED !!**

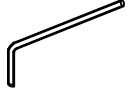
HARDWARE LIST				
NO		DESCRIPTION		QTY
1		BOLT	M6X50 mm	8PCS
2		Flat Washer	M6	8PCS
3		Wrench	M4	1PC

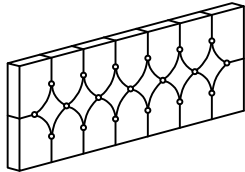
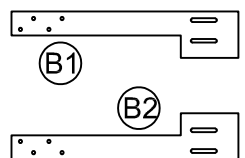
PART LIST			
NO		DESCRIPTION	QTY
A		HEADBOARD	1PC
B		WOODEN LEGS	2PCS

# ASSEMBLY INSTRUCTIONS

MODEL : #1508-105 (V#12600CF SB1)

## STEP 1 :

Unstrap the black non-woven fabric on the back of headboard and take out headboard leg and hardware kit.

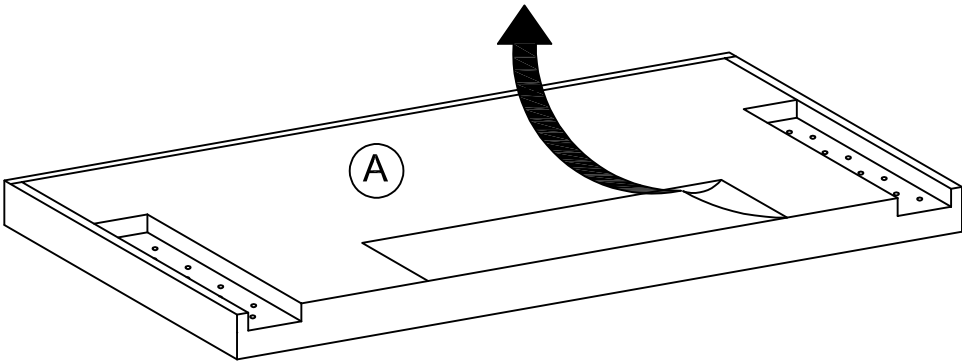

Attention: Strap the black non-woven fabric after take out the parts!!

## STEP 2 :

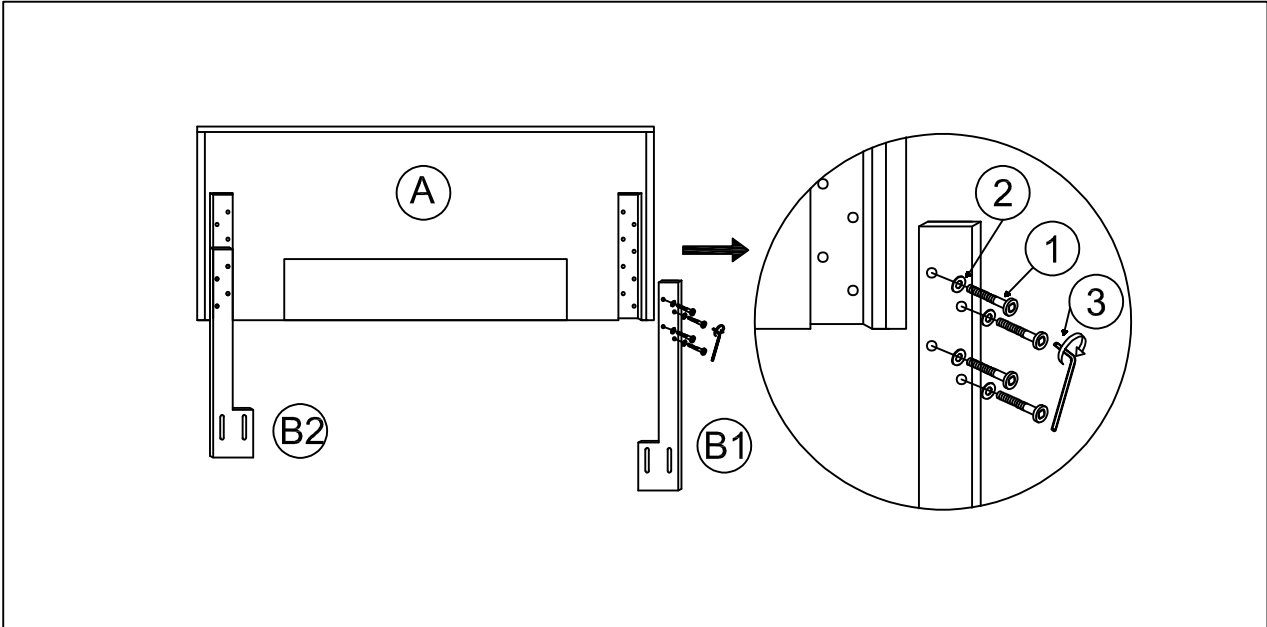

# ASSEMBLY INSTRUCTIONS

MODEL : #1508-105 (V#12600CFSB1)

STEP 3 :

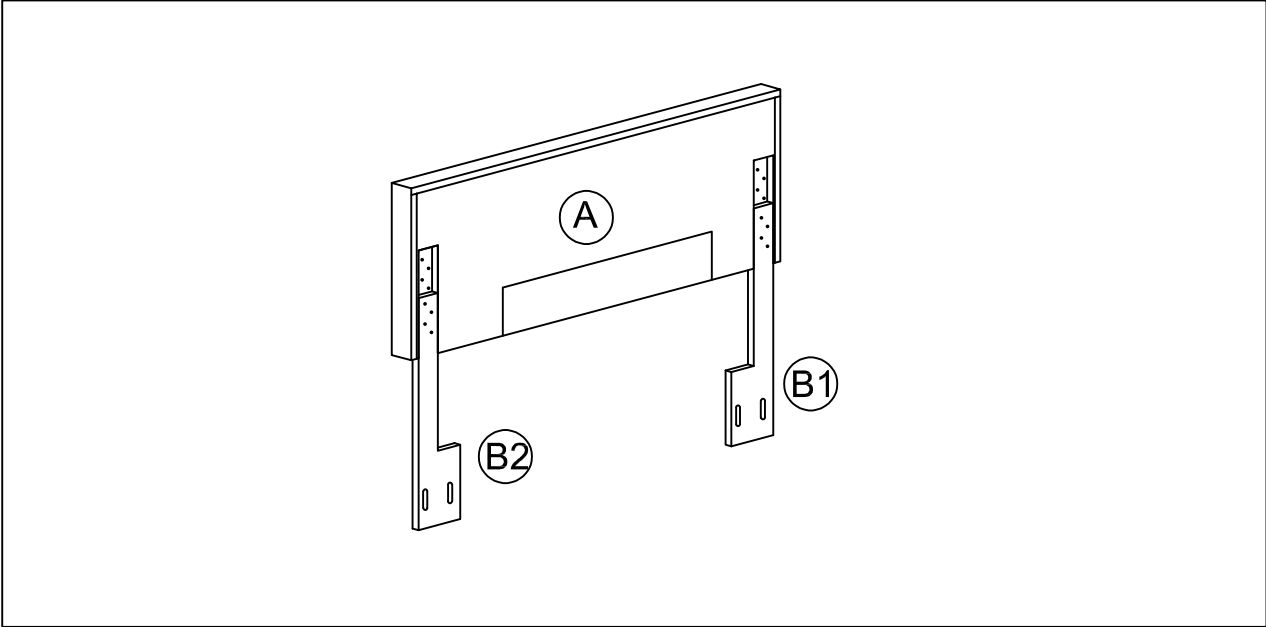

STEP 4 :

