

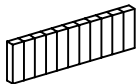









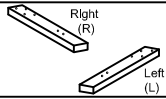

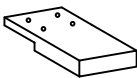
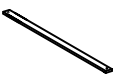



ASSEMBLY INSTRUCTIONS

MODEL : #1134-110 (V#12600CFSB1)

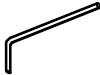
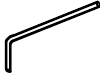
**NOTE : THIS ITEM NOT RECOMMENDED FOR COMMERCIAL USE
KEEP THIS DOCUMENT FOR REFERENCE IN CASE PARTS ARE NEEDED**

DO NOT TIGHTEN SCREWS UNTIL COMPLETELY ASSEMBLED !!

NO		DESCRIPTION	QTY
A		Headboard	1pc
B		Footboard	1pc
C		Side Rail	4pcs
D		Headboard Legs	2pcs
E		Support Legs	8pcs
F		Legs	2pcs
G		Side Rail Legs	2pcs
H		Center Rail	4pcs
I		Slat	14pcs

NO		DESCRIPTION	QTY
1		JCBB M8 x 20	8pcs
2		JCBC M6 x 30	8pcs
3		JCBC M6 x 50	6pcs
4		JCBC M6 x 60	8pcs
5		Wrench Key 65mm	1pc
6		Wrench Key 70mm	1pc
7		CSK Screw 32mm	28pcs
8		Spring Washers	6pcs
9		Flat Washers	8pcs
10		Adjuster	8pcs
11		USB Port	1set
12		CSK Screw 16mm	4pcs

ASSEMBLY INSTRUCTIONS

MODEL : #1134-110 (V#12600CFB1)

STEP 1 :

Unzip the black non-woven fabric on the back of headboard and take out the part.

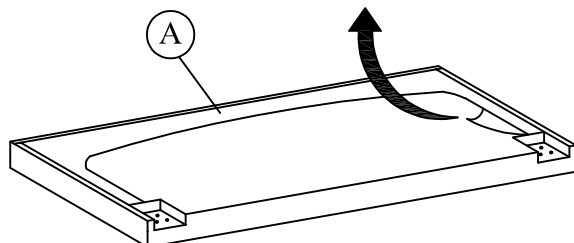

Attention: Zip the black non-woven fabric after take out the parts !!

BACK VIEW

STEP 2 :

Fix the headboard (A) and headboard legs (D), Then fix the footboard (B) with footboard legs (F) as shown.

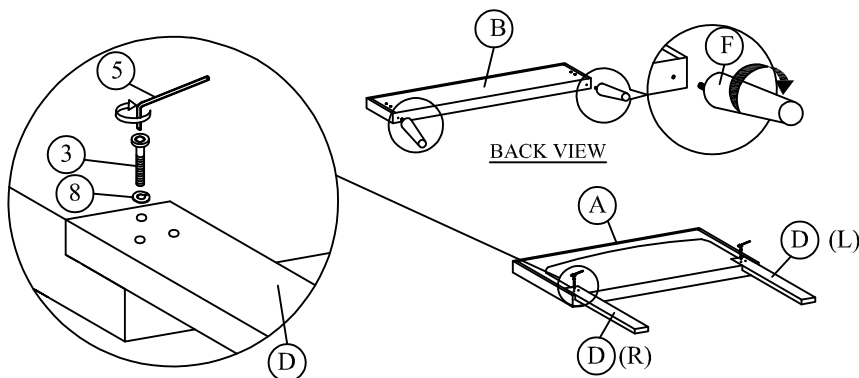

STEP 3 :

Attach the JCBB Bolt (1) to the headboard and footboard.

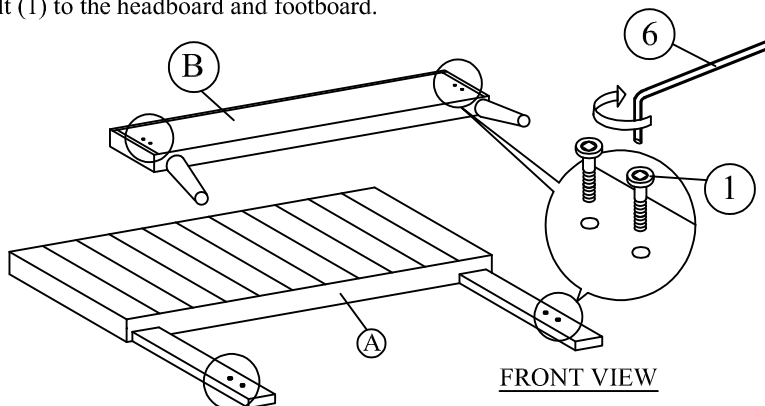

ASSEMBLY INSTRUCTIONS

MODEL : #1134-110 (V#12600CF SB1)

STEP 4 :

Attach the side rail leg (G) to the side rail (C).

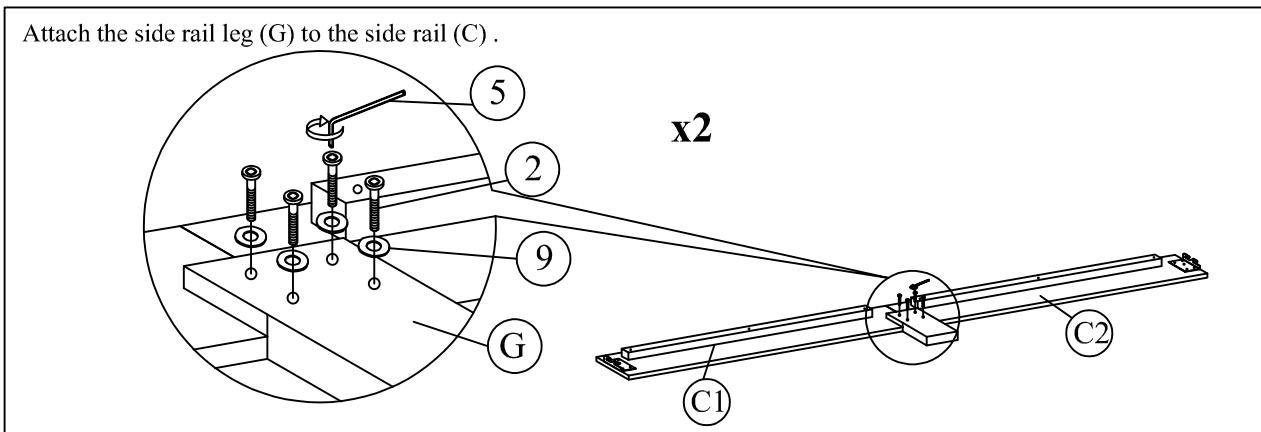

STEP 5 :

Attach side rail (C) to headboard (A) and footboard (B) by pushing the bracket down to fit it.

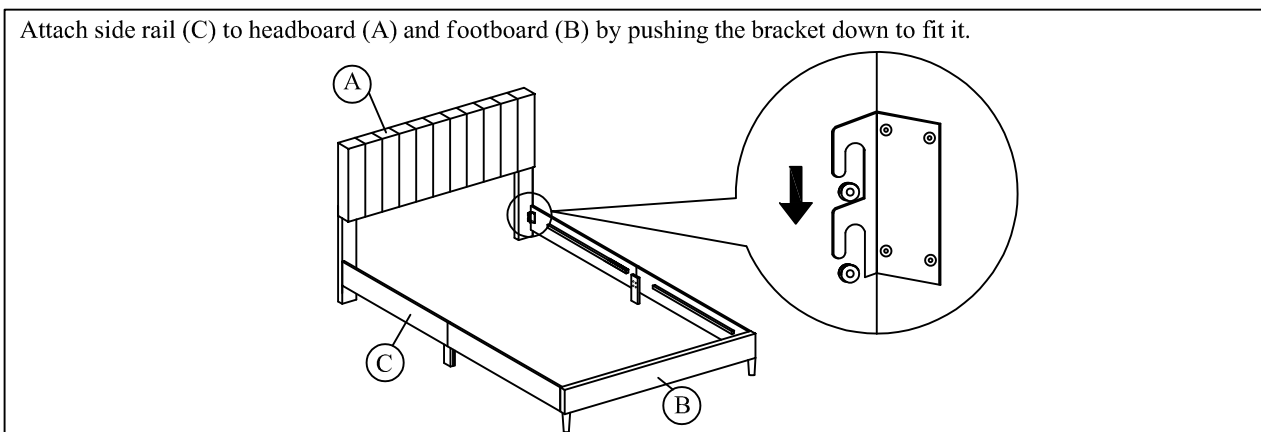

STEP 6 :

Attach the support legs (E) to the center rail (H) and slats (I) of the bed as shown.

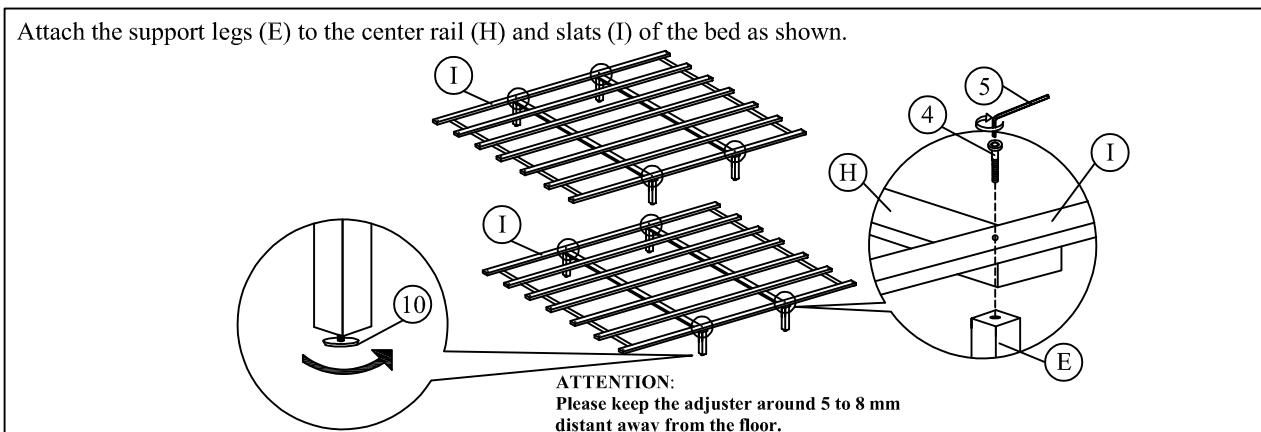

ASSEMBLY INSTRUCTIONS

MODEL : #1134-110 (V#12600CFB1)

STEP 7 :

Affix the Slat (I) to the side rail support wood. Tighten all the 4 corner. Tighten the slats with CSK screw.

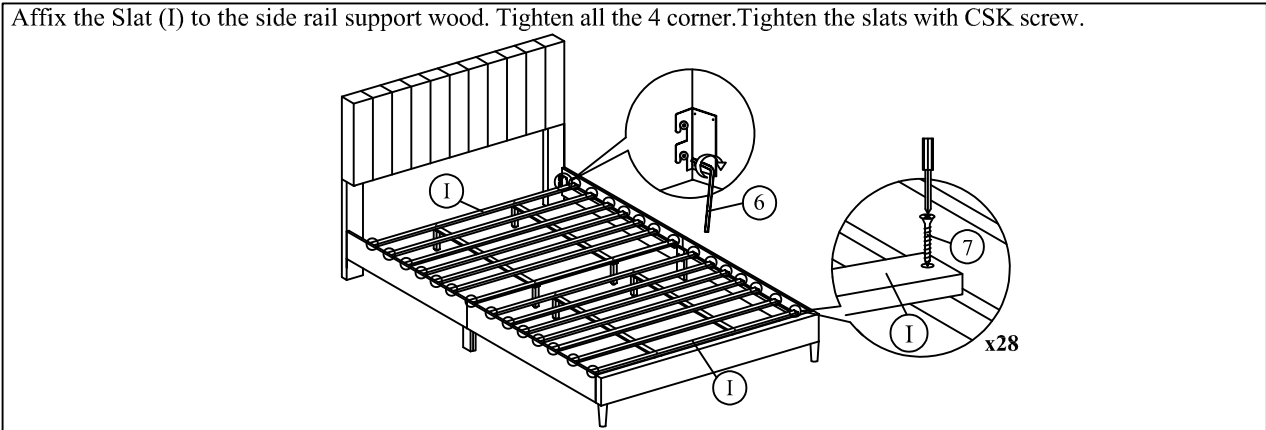

STEP 8 :

Attach the USB at the back of the headboard (Screw in at the marking provided).

