

70136, 70536, 70636



Boraam Industries

SHAKER TABLE

ASSEMBLY INSTRUCTIONS

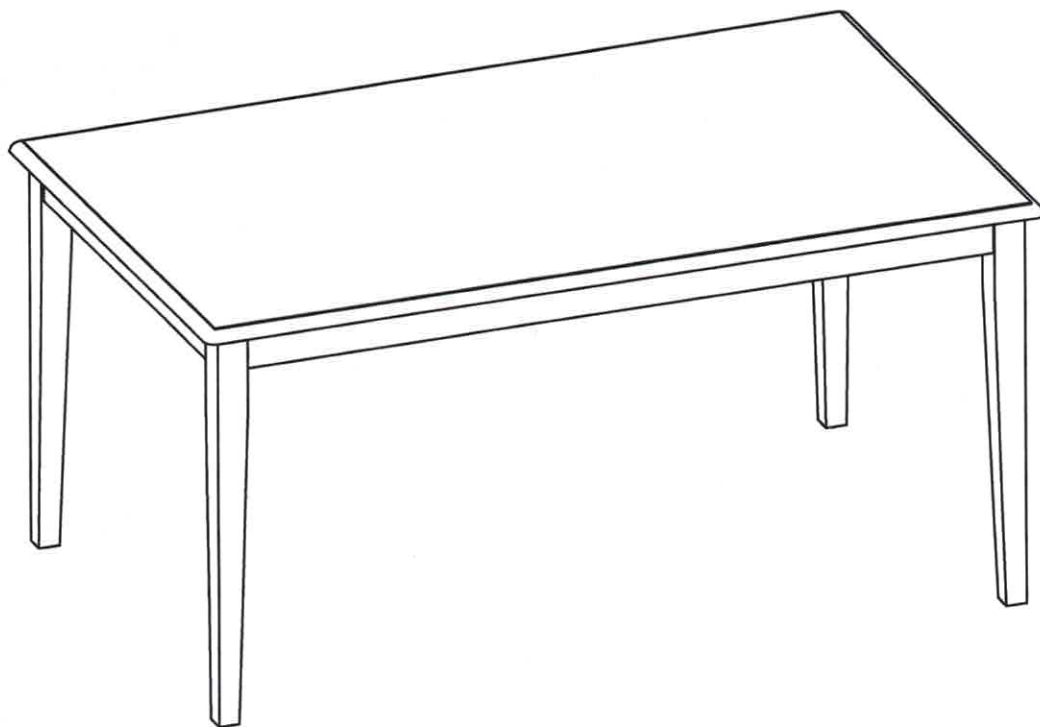

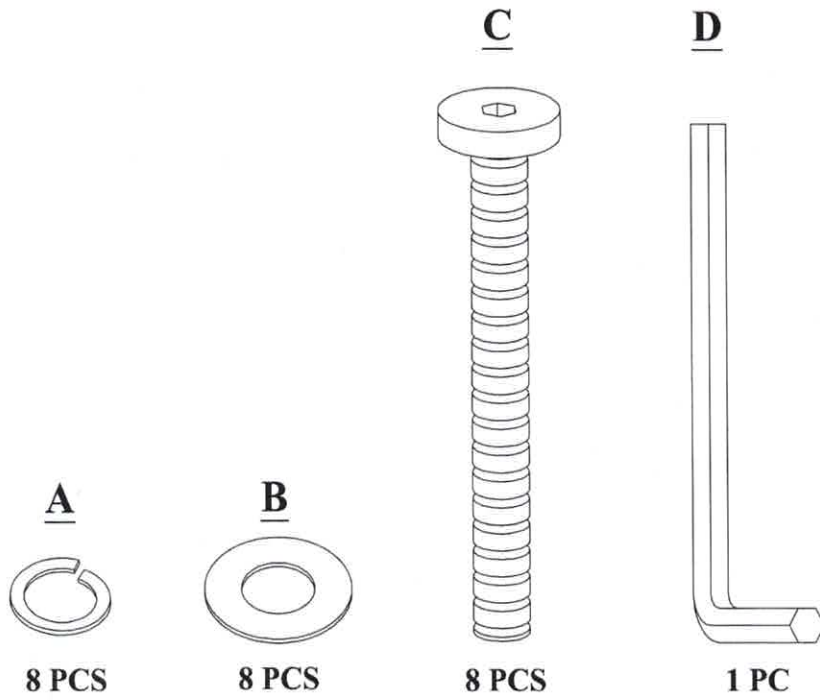

①

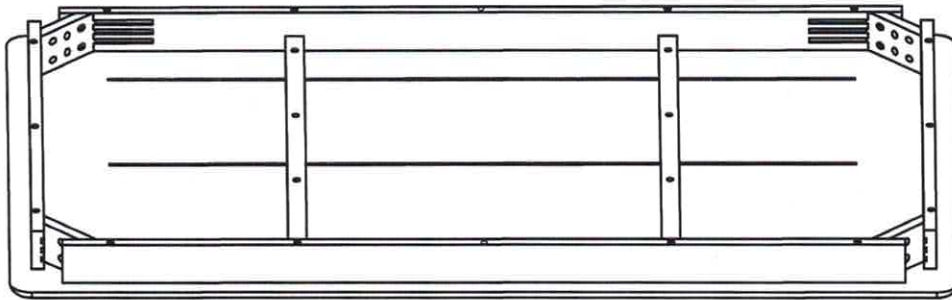

②

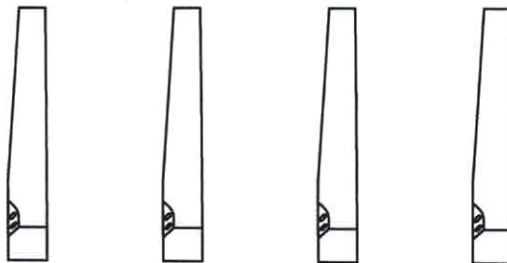

01

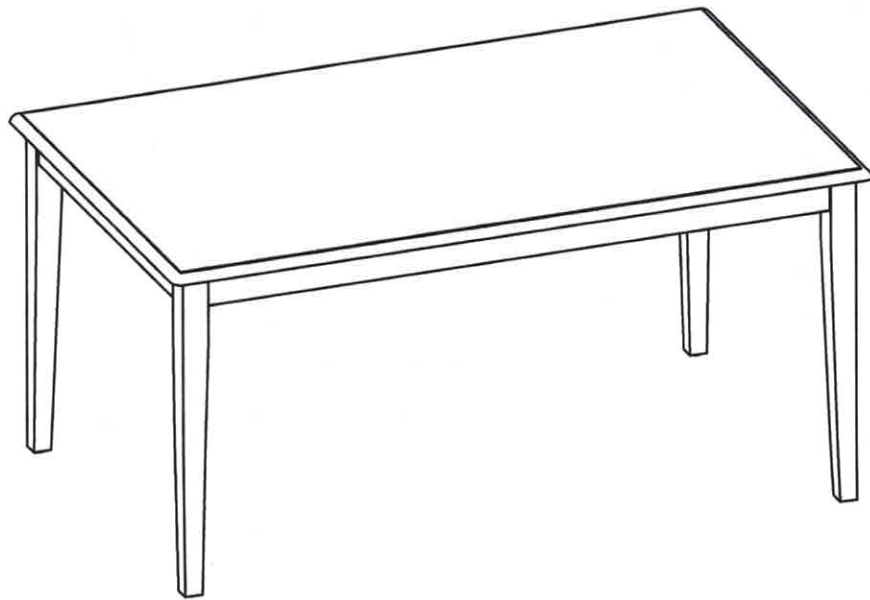
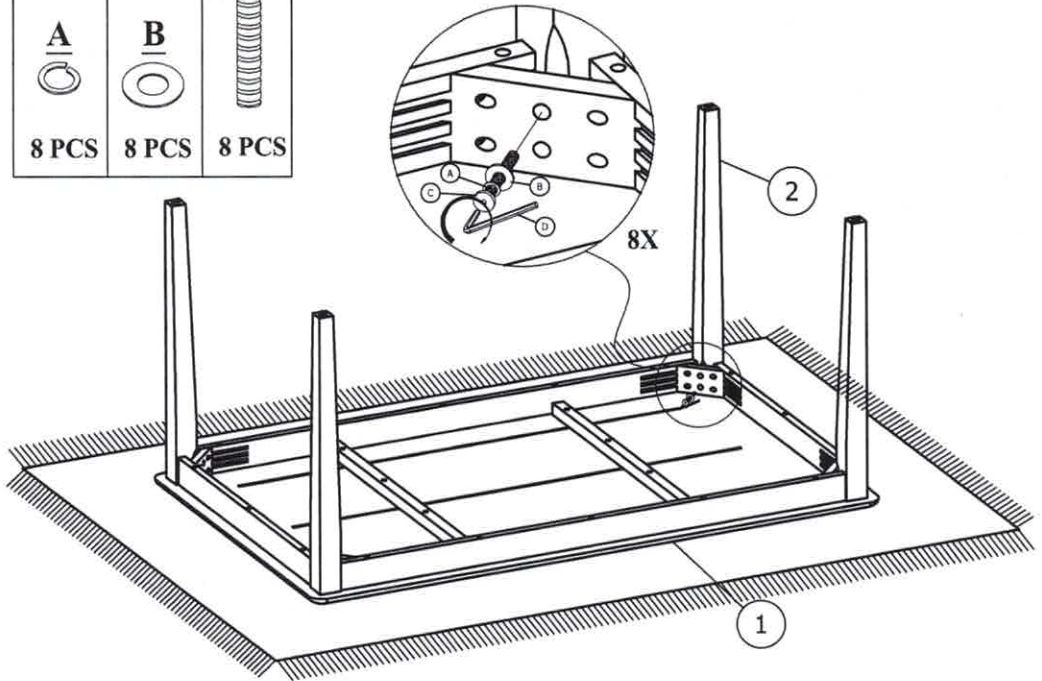
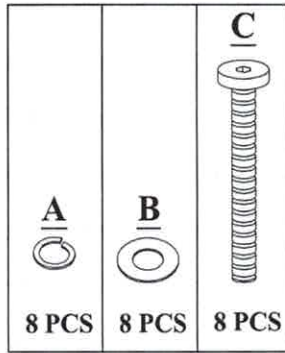

BE SURE TO CHECK ALL BOLTS ARE SECURELY TIGHTENED PRIOR USING THIS TABLE