

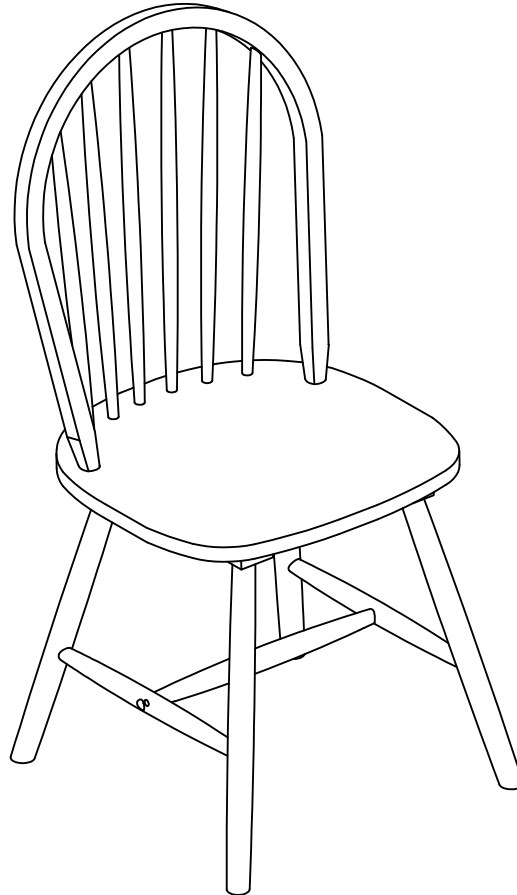

# Boraam Industries

ASSEMBLY INSTRUCTIONS

**SKU: 31616 | CAROLINA DINING CHAIR**



Have questions about assembling your item?



Items or parts damaged?



Missing a part?

**We're here to help! (Monday-Friday from 9am-5pm CST)**



847-949-6300  
877-267-2261



customerservice@  
boraamindustries.com



www.boraamindustries.com

Phillips  
Screwdriver  
(Not provided)

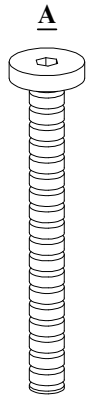

**A**  
M6\*60  
4 PCS

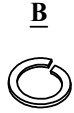

**B**  
Spring Washer  
8 PCS

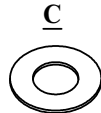

**C**  
Flat Washer  
8 PCS



**D**  
M6\*13  
4 PCS

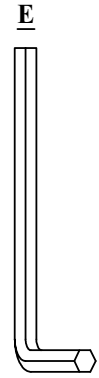

**E**  
1 PC  
Allen Wrench



**F**  
Wood Button  
2 PCS



**G**  
Wood Button  
2 PCS

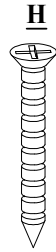

**H**  
M4\*30  
6 PCS

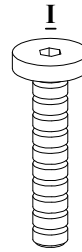

**I**  
M6\*35  
6 PCS



**J**  
Glue tube  
1 PC

①

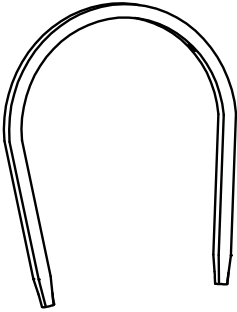

②

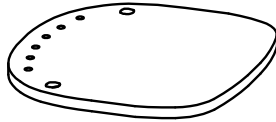

③

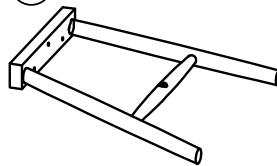

④

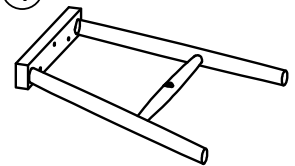

⑤

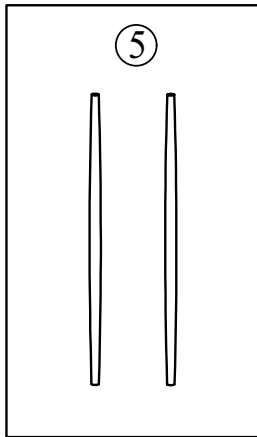

⑥

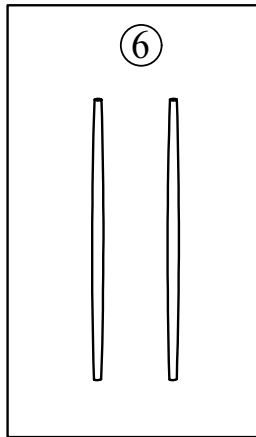

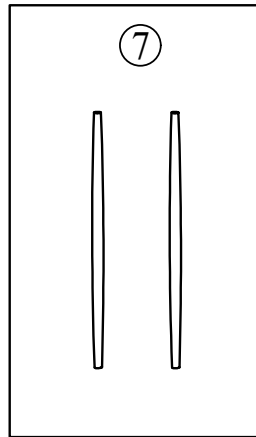

⑦

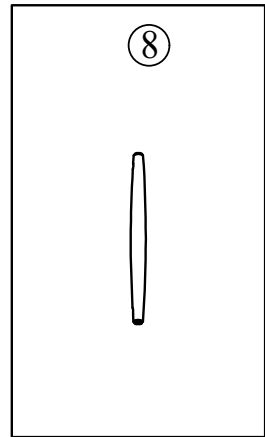

⑧



# 01

<b>H</b> 	Phillips Screwdriver (Not provided)
<b>6 PCS</b> <b>M4*30</b>	

Do not use Power Tools to assemble.

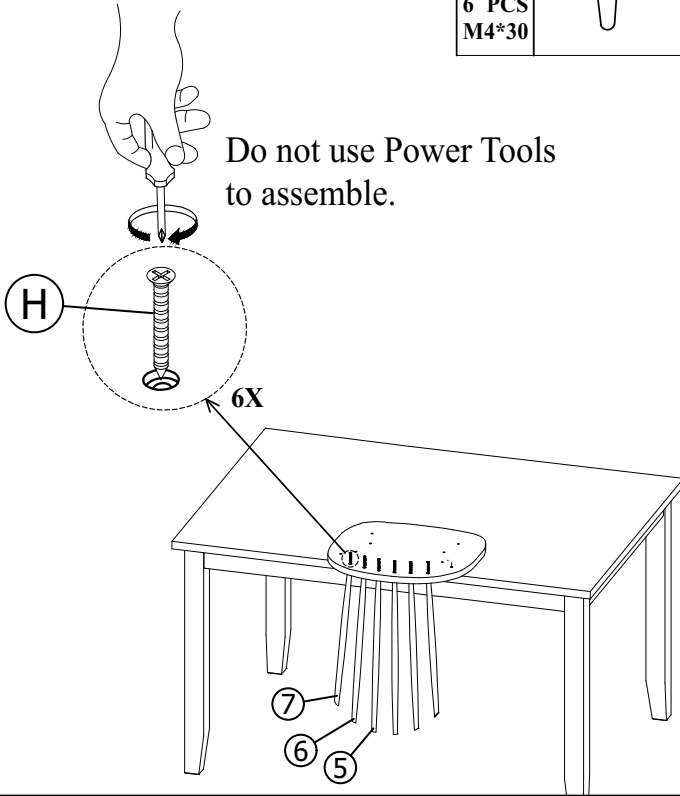



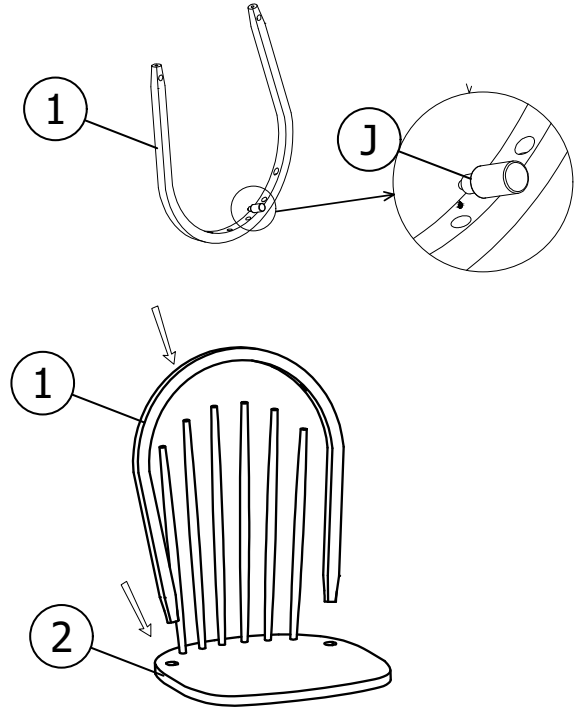

# 02

<b>J</b> 
<b>1 PC</b> <b>Glue tube</b>

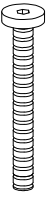

# 03

<b>A</b> 	<b>B</b> 	<b>C</b> 	<b>D</b> 
<b>M6*60</b> <b>2 PCS</b>	<b>2 PCS</b>	<b>2 PCS</b>	<b>M6*13</b> <b>2 PCS</b>

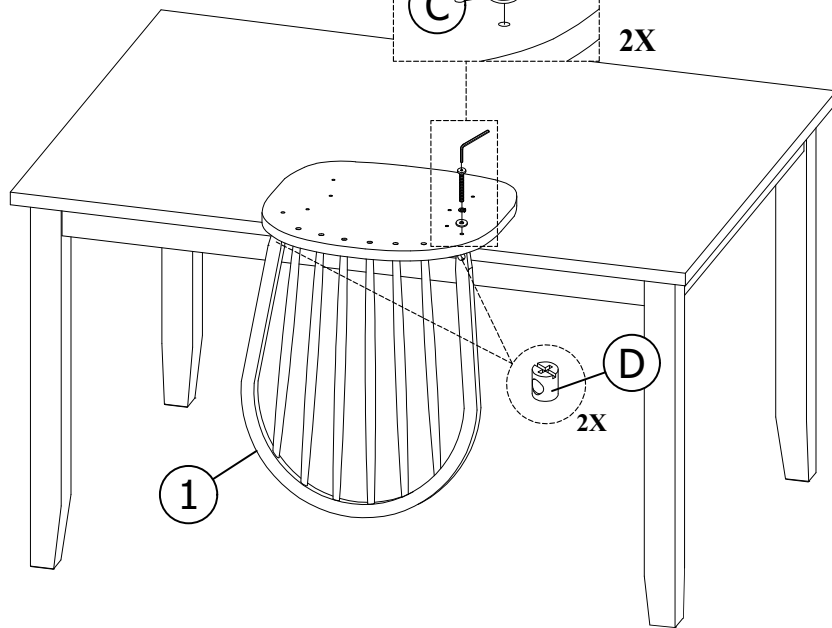
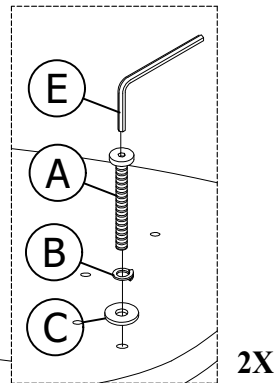

# 04

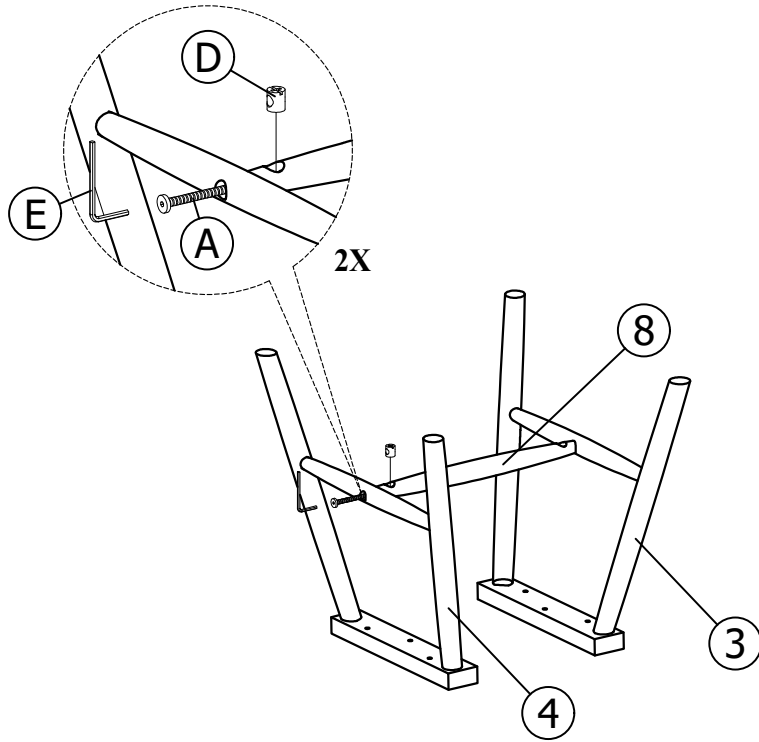
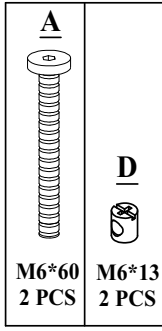

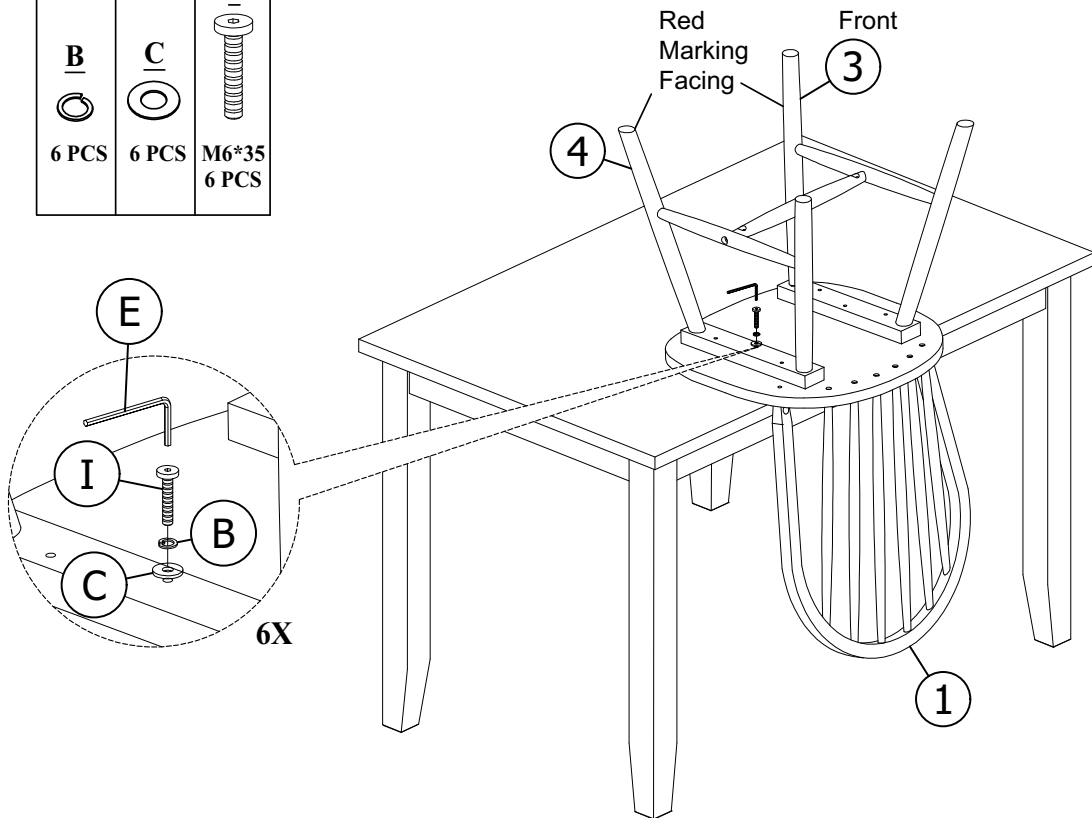
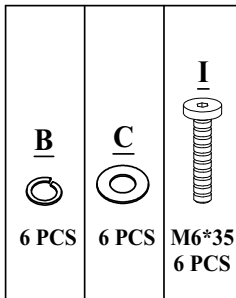

DO NOT TIGHTEN BOLT COMPLETELY.

# 05



TIGHTEN BOLT COMPLETELY.

**06**

<p><b>F</b></p>  <p>Wood Button 2 PCS</p>	<p><b>G</b></p>  <p>Wood Button 2 PCS</p>
--	--

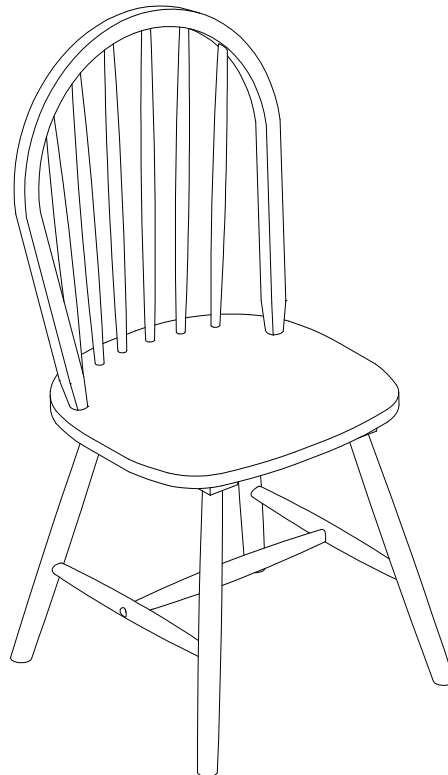
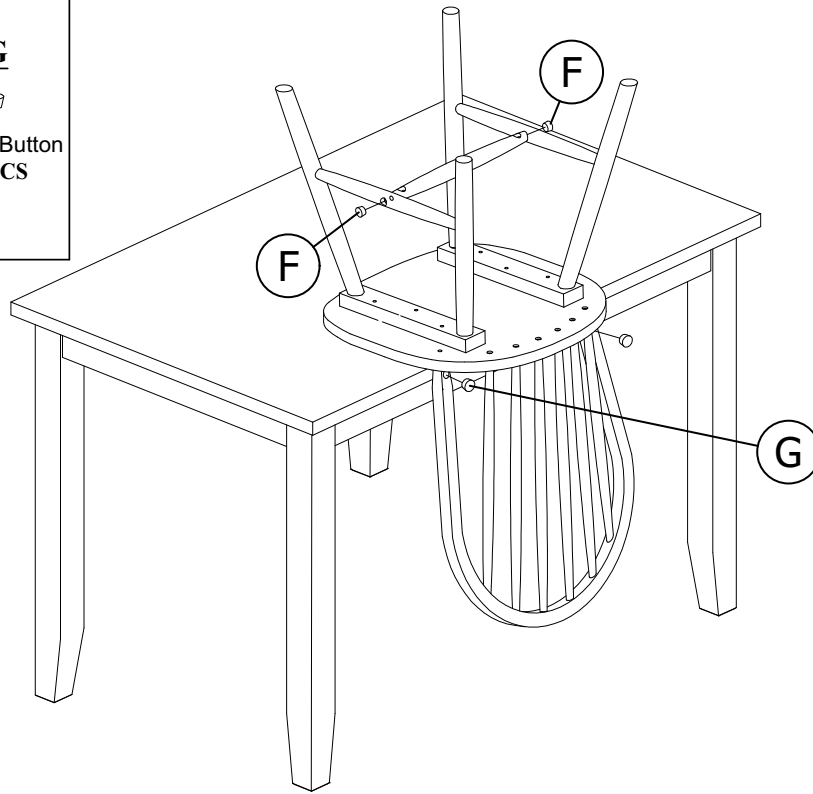

BE SURE TO CHECK ALL BOLTS ARE SECURELY TIGHTENED PRIOR USING THIS CHAIR

847-949-6300 | 877-267-2261 | [customerservice@boraamindustries.com](mailto:customerservice@boraamindustries.com)