

9749 Twin Headboard

Assembly Instructions

W11-0720

1 Parts List

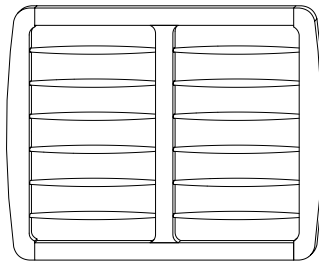

A
Headboard
Panel x 1

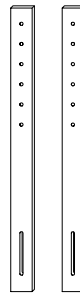

B
Support
Bars x 2

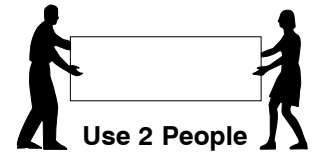

2 Hardware List



1 M6 x 35mm JCB
x 10



2 Spring Washer
x 10



3 Flat Washer
x 10



4 Allen Key
x 1

Note: Do not assemble
using power tools.
This can cause the bolts
to be overtightened

3 Assemble the Support Bars (B) to the Headboard Panel.

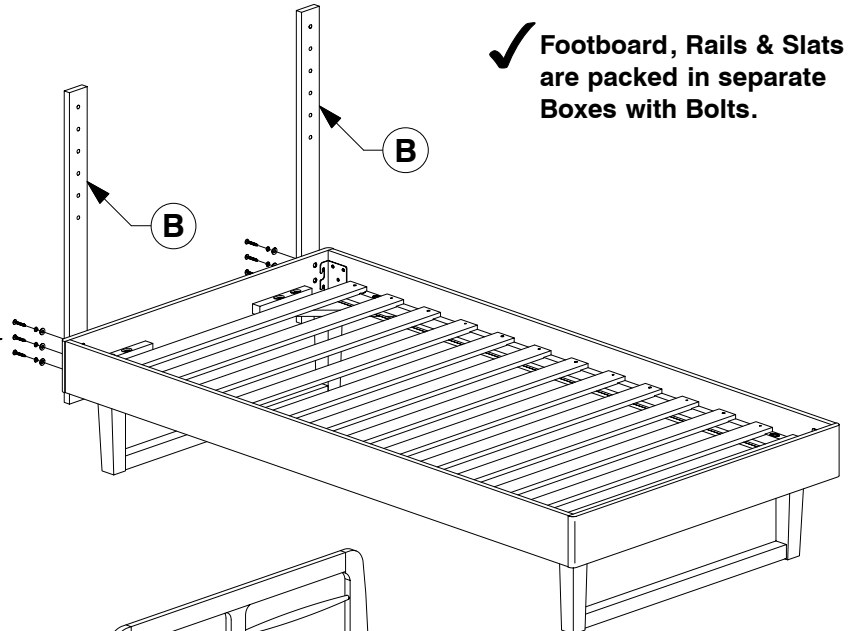
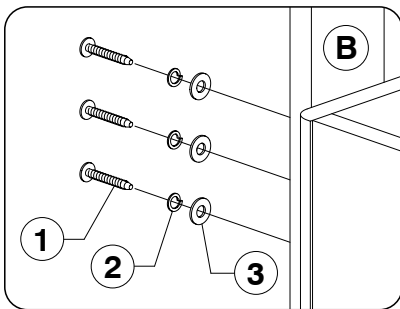

4 Assemble the Headboard Panel (A) to the Support Bars (B).

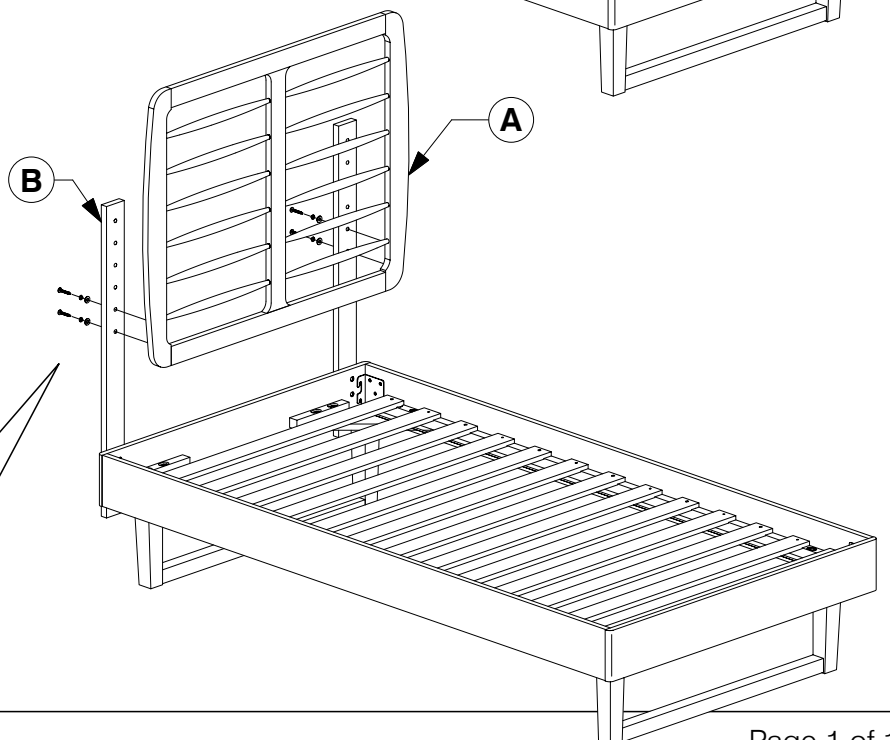
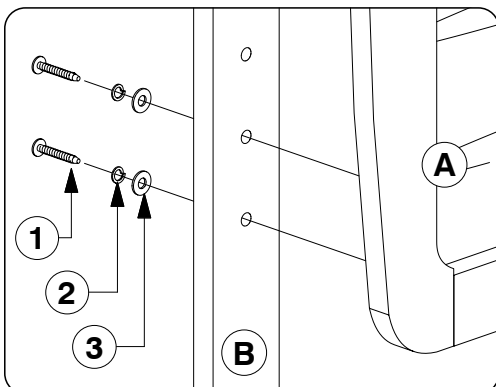

9704 Twin Bed

Assembly Instructions

W11-0720

1 Assembled View

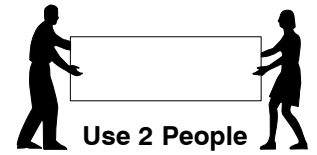
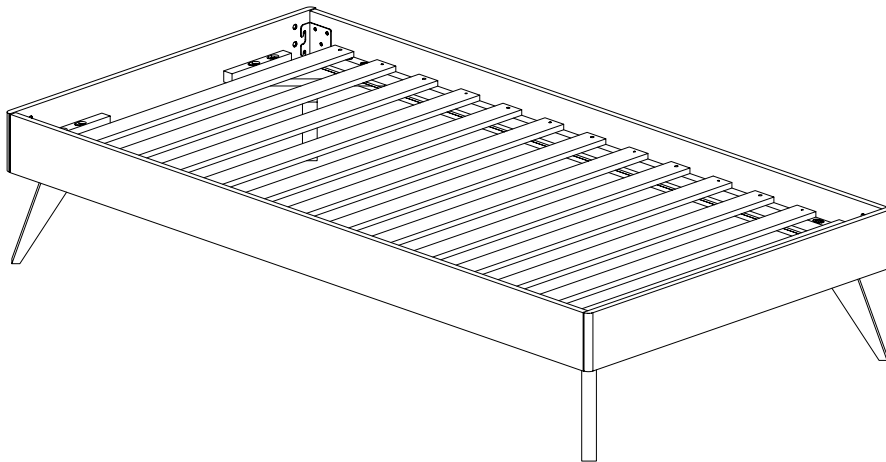

Note: Do not assemble using power tools. This can cause the bolts to be overtightened

2 Parts List

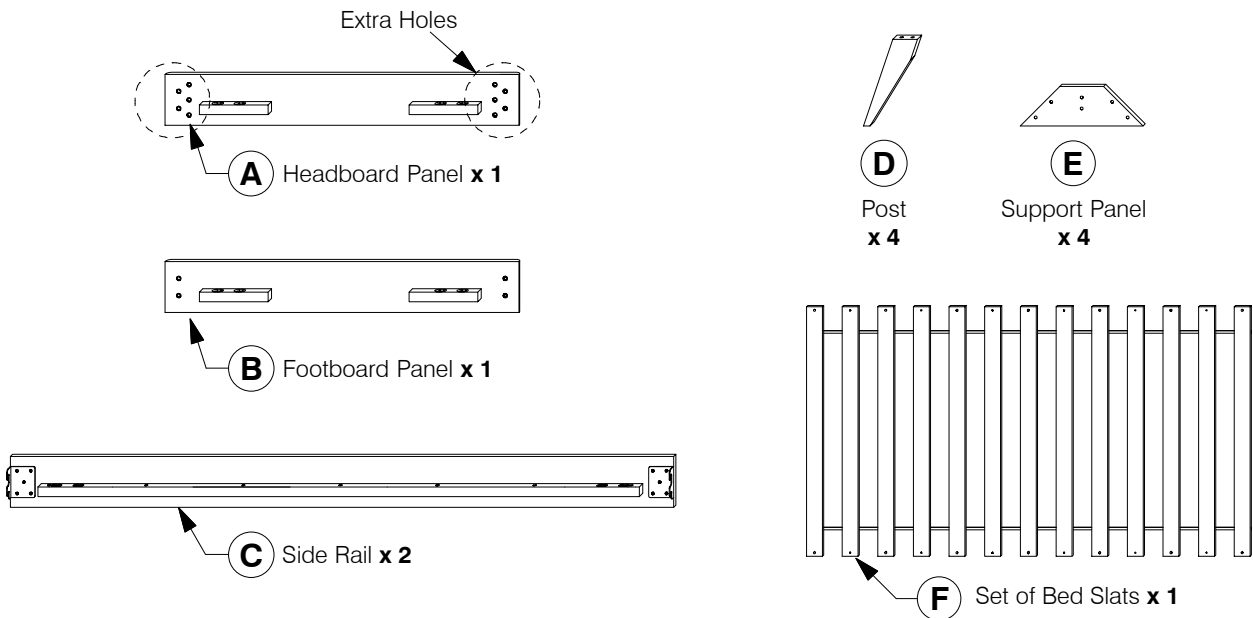

3 Hardware List



1 M6 x 50mm JCB x 16



2 M6 x 40mm JCB x 14

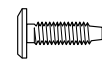

3 M6 x 20mm JCB x 8



4 M8 x 50mm JCB x 8



5 Spring Washer x 24



6 Flat Washer x 24

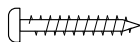

7 Wood Screw (M4 x 32mm) x 12



8 M4 Allen Key x 1



9 M5 Allen Key x 1

9704 Twin Bed

Assembly Instructions

WII-0720

- 4** Fit the Post (D) to the Support Panel (E).

x4

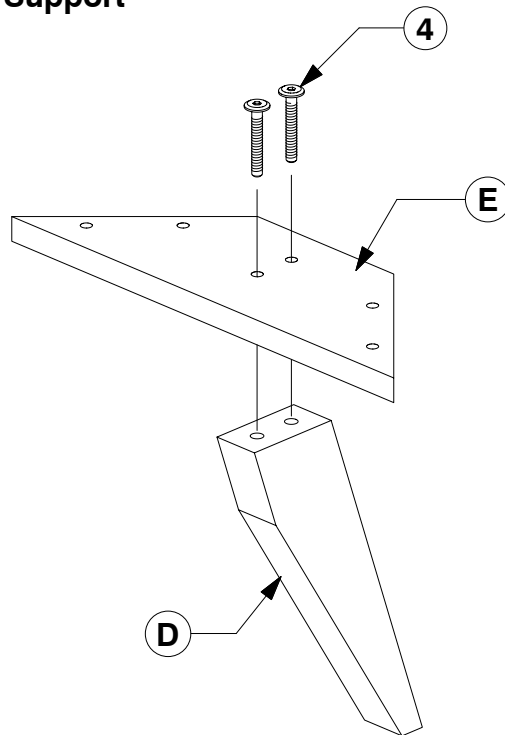

- 5** Bolt the Post & Support Panel (D & E) to the Side Rail (C).

x2

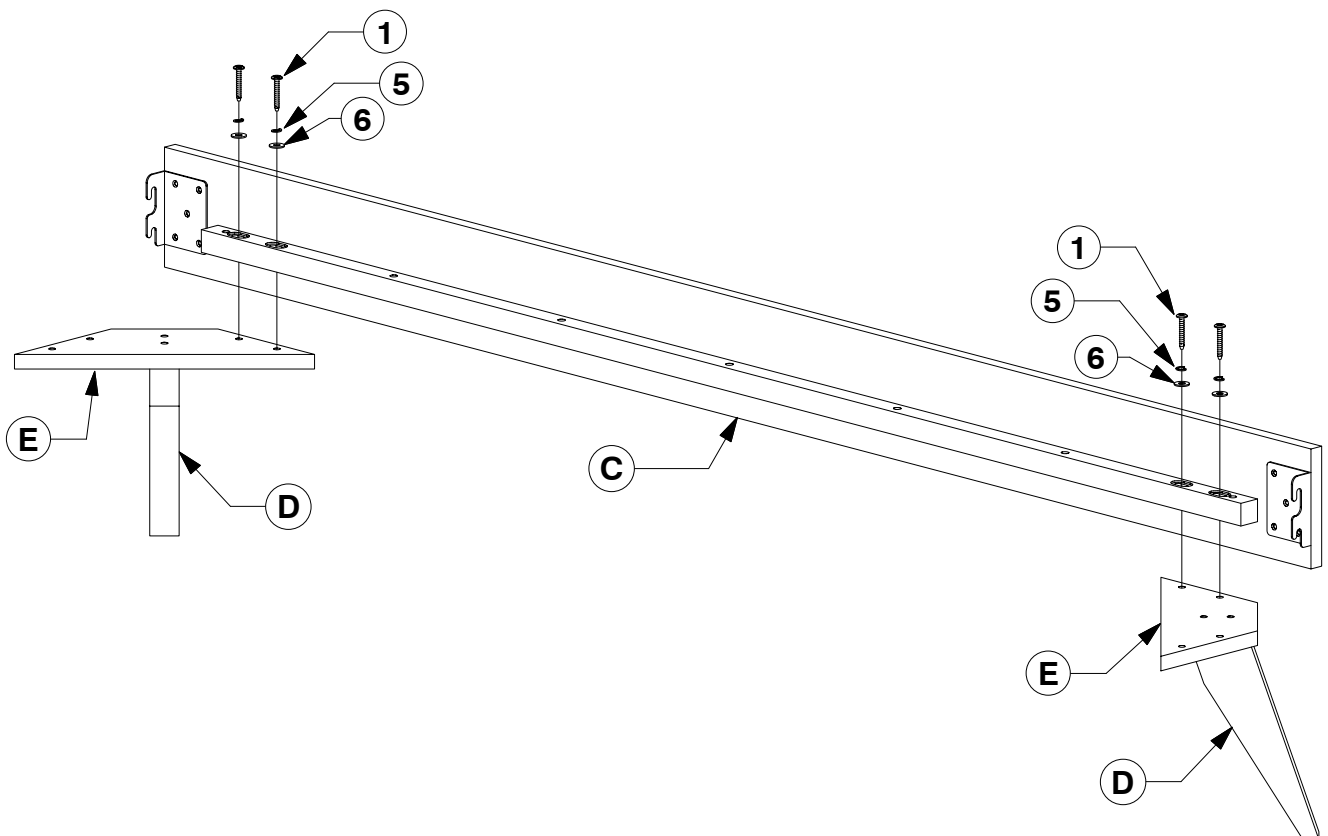

9704 Twin Bed

Assembly Instructions

W11-0720

- 6 Assemble the Side Rail (C) to the Headboard and Footboard Panel (A & B).**

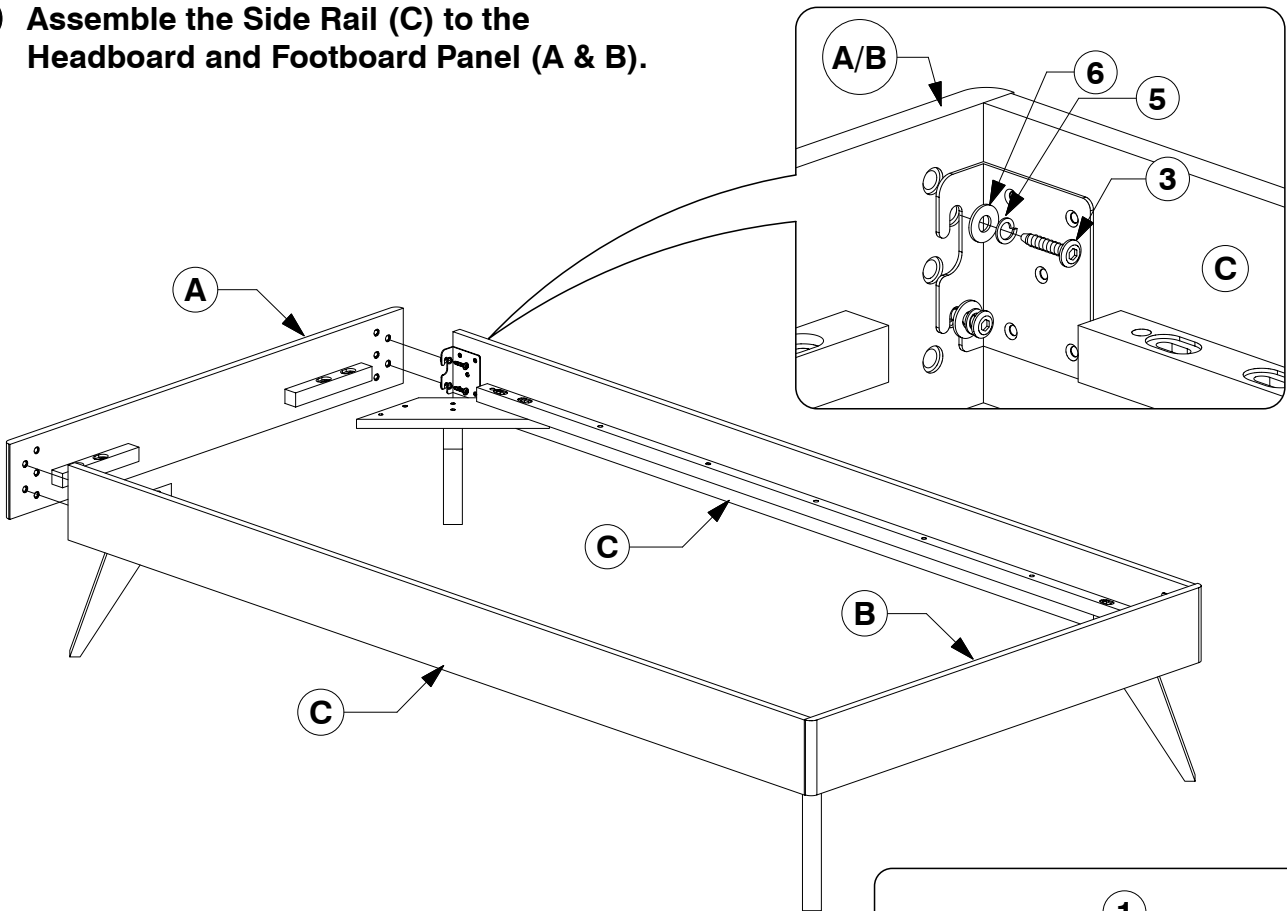

- 7 Bolt the assembled Support Panel (E) to the Headboard and Footboard Panel (A & B).**

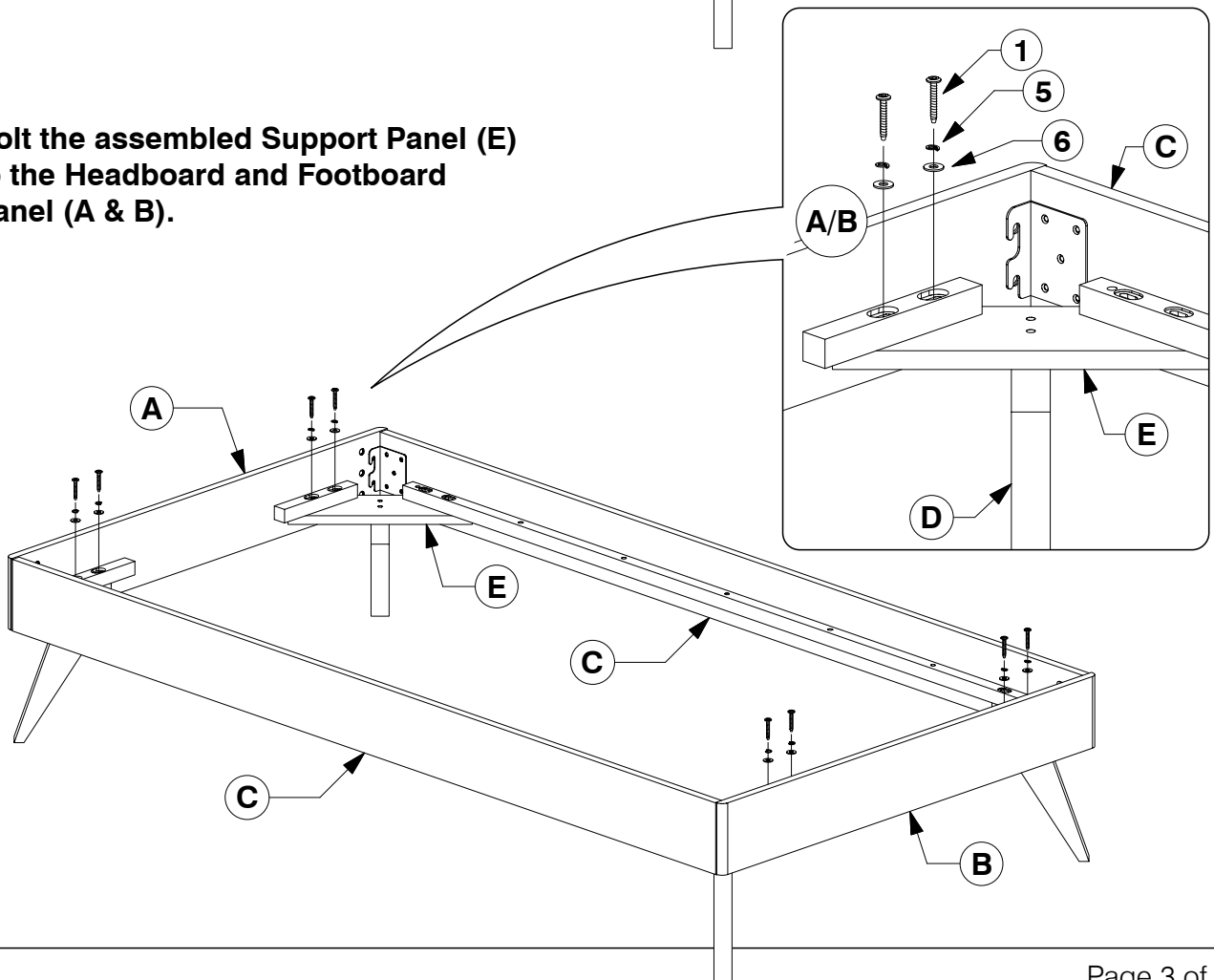

9704 Twin Bed

Assembly Instructions

W11-0720

8 Bolt the Bed Slats (F) to the Side Rail (C).

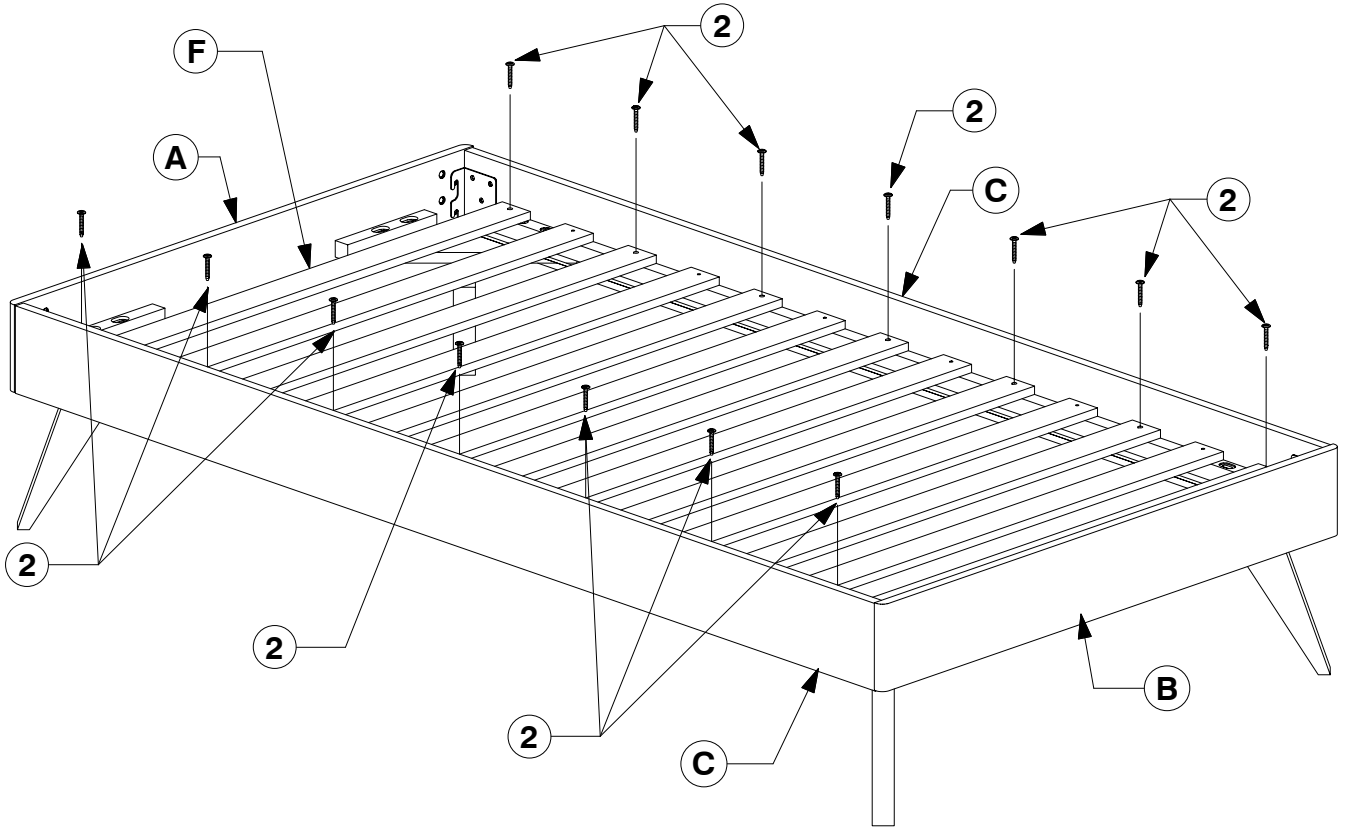

9 Screw the Bed Slats (F) to the Side Rail (C).

