

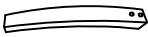

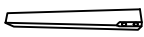



ASSEMBLY INSTRUCTION

PARTS LIST

| No | Drawing | Description | Qty |
|----|---|--------------|-----|
| 1 |  | SEAT CUSHION | 1 |
| 2 |  | BACK LEG | 2 |
| 3 |  | FORNT LEG | 2 |

HARDWARE LIST

| No | Drawing | Description | Qty |
|----|--|----------------------|-----|
| A |  | 5mm | 1 |
| B |  | $\phi 5/16 * 2-1/4"$ | 4 |
| E |  | $\phi 5/16 * 1-3/4"$ | 4 |
| C |  | $\phi 5/16$ | 8 |
| D |  | $\phi 5/16$ | 8 |

Complete assembly

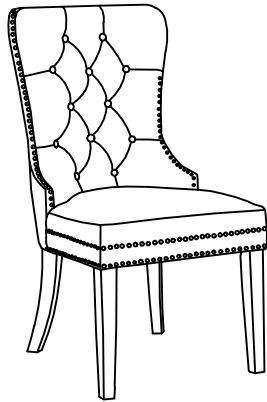

STEP 1

Legs and hardware package are put inside the bottom of the chair.

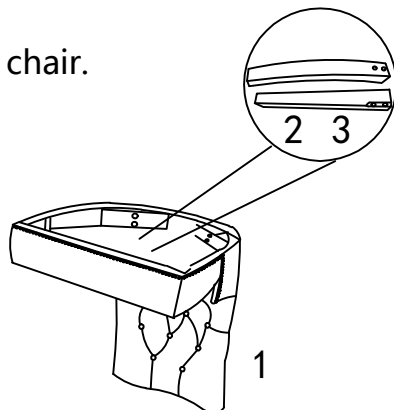

STEP 2

