

# SW 5218 COFFEE TABLE

(This assembly method also apply to side table)

1.

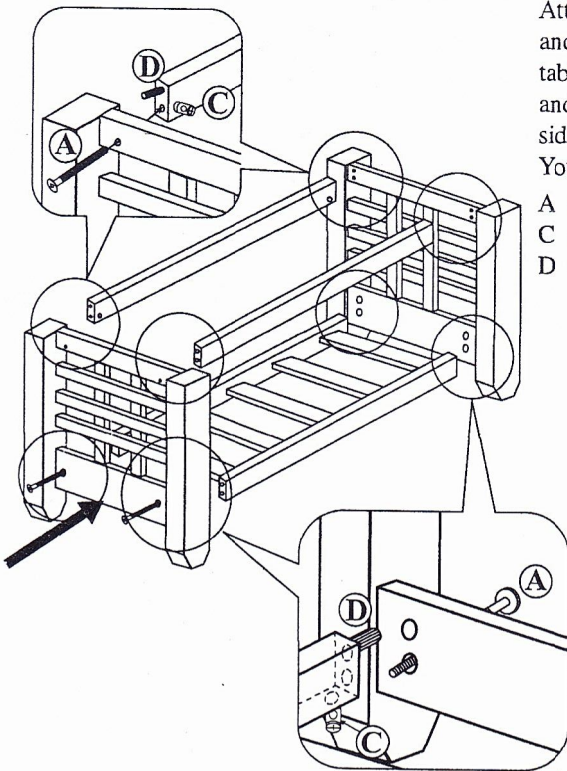

Attach the newspaper rack (P3) and upper rail (P4) to the table leg (P2). Complete one side first and repeat the same for the other side of table leg (P2).





You will need to use hardware:

- A = 8pcs
- C = 8pcs
- D = 8pcs

## WARNING!!

- Remove hardware from box and sort by size.
- Please check to see that hardware and parts are present prior start of assembly.
- Please follow attached instruction in the same sequence numbered to ensure fast and easy assembly.
- Do not use this table if any part is broken, torn or missing.
- The assembly of this product requires two people.
- Do not use any power tools as this may damage the frame and will invalidate any claim.
- Please do not tighten the unit until fully set up for the easy of parts intallation.

## PART LIST

P1		Table Top	= 1pcs
P2		Table Leg	= 2pcs
P3		Newspaper Rack	= 1pcs
P4		Rail (upper)	= 2pcs

2.

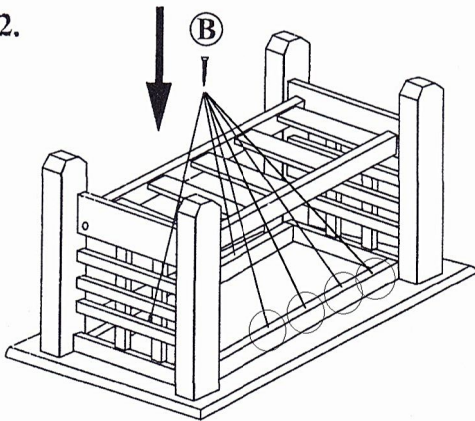





Place the table top upside down on a non-abrasive surface. Attach the table top to the upper rail. You will need to use hardware:

- B = 8pcs (CT)
- 6pcs (ST)

**\*\* For side table only 3 pcs screw each side apply only**

\*\*

## HARDWARE LIST

A		M6 x 50mm JCBC	8pcs
B		M4 X 25mm SCREW (CT)	8pcs
		(ST)	6pcs
C		BARREL NUT	8pcs
D		Ø8 x 35mm WOOD DOWEL	8pcs
E		ALLEN KEY M4	1pcs

## FULLY SET UP

