

ASSEMBLY INSTRUCTION

MODEL : 038 BENCH





Read this instruction carefully. Remove all wrapping material, staples and straps from the carton. See hardware and furniture part list

For guidance. Be sure you have all wooden furniture parts on a clean and flat soft surface, such as a carpet or rug, to prevent from being scratched. Follow the figure to start assembling.

CAUTION :

1. Do not FULLY - TIGHTEN the nut or screw until all is ready to assemble.
2. Do not OVER - TIGHTEN the nut or screw to avoid causing damages to the thread.
3. Keep all hardware part out reach of children.

PART LIST		
No.	DESCRIPTION	QTY
A	CHAIR TOP	1 PC
B	TABLE LEG	4 PCS

HARDWARE LIST			
No.	DESCRIPTION		QTY
1	FLAT WASHER 6/19"		8 PCS
2	SPRING WASHER 6/13"		8 PCS
3	JCBC SCREW M6 X 70MM		8 PCS
4	M4 ALLEN KEY		1 PC

STEP 1

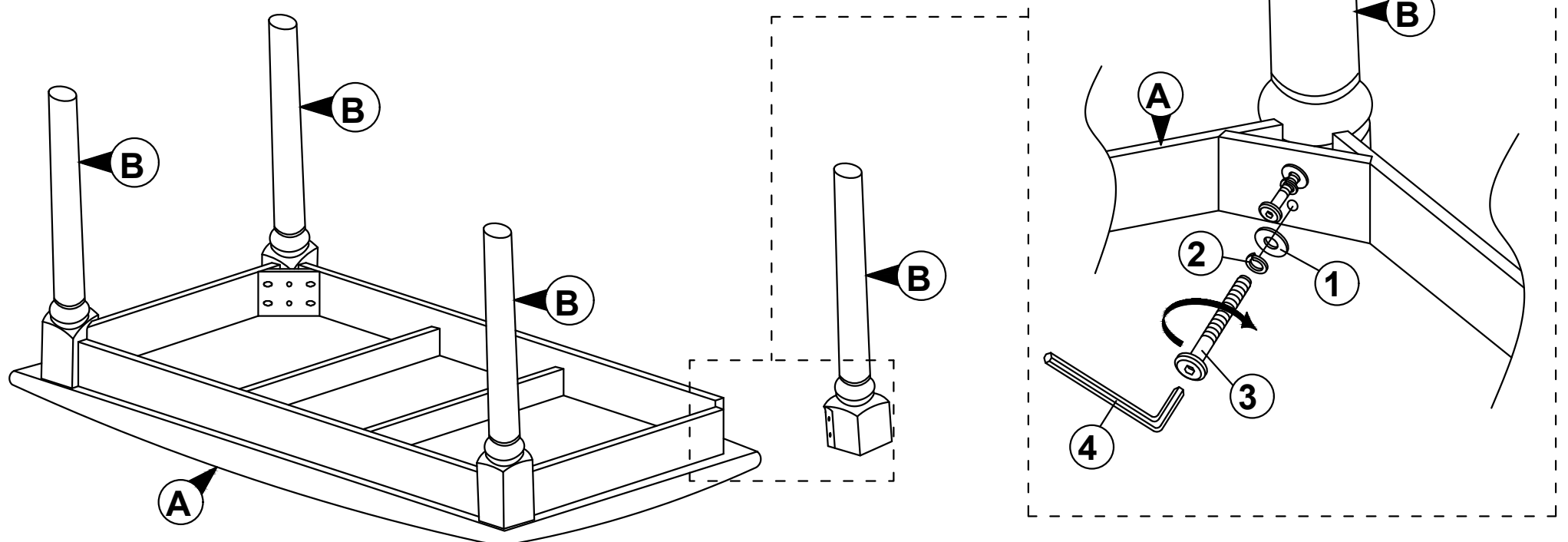

STEP 2



COMPLETED TABLE ASSEMBLY