

---

## ASSEMBLY INSTRUCTIONS

# PARTS AND HARDWARE

Avoid using sharp objects such as a knife to cut open packing as you may accidentally damage the upholstery.



A:3PCS



B:3PCS



C:2PCS



D:2PCS

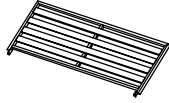

E:1PC

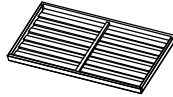

F:1PC

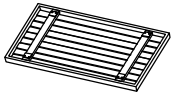

G:1PC



H:2PCS

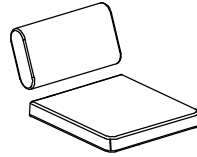

I:4PCS



M6\*30

J:24PCS



M6\*15

K:8PCS



L:1PC

Do not fully tighten bolts until assembly is complete.  
1. Assemble the chair arms (A) and (B) to the seat (D) and the backrest (C), using bolts and washer (J).

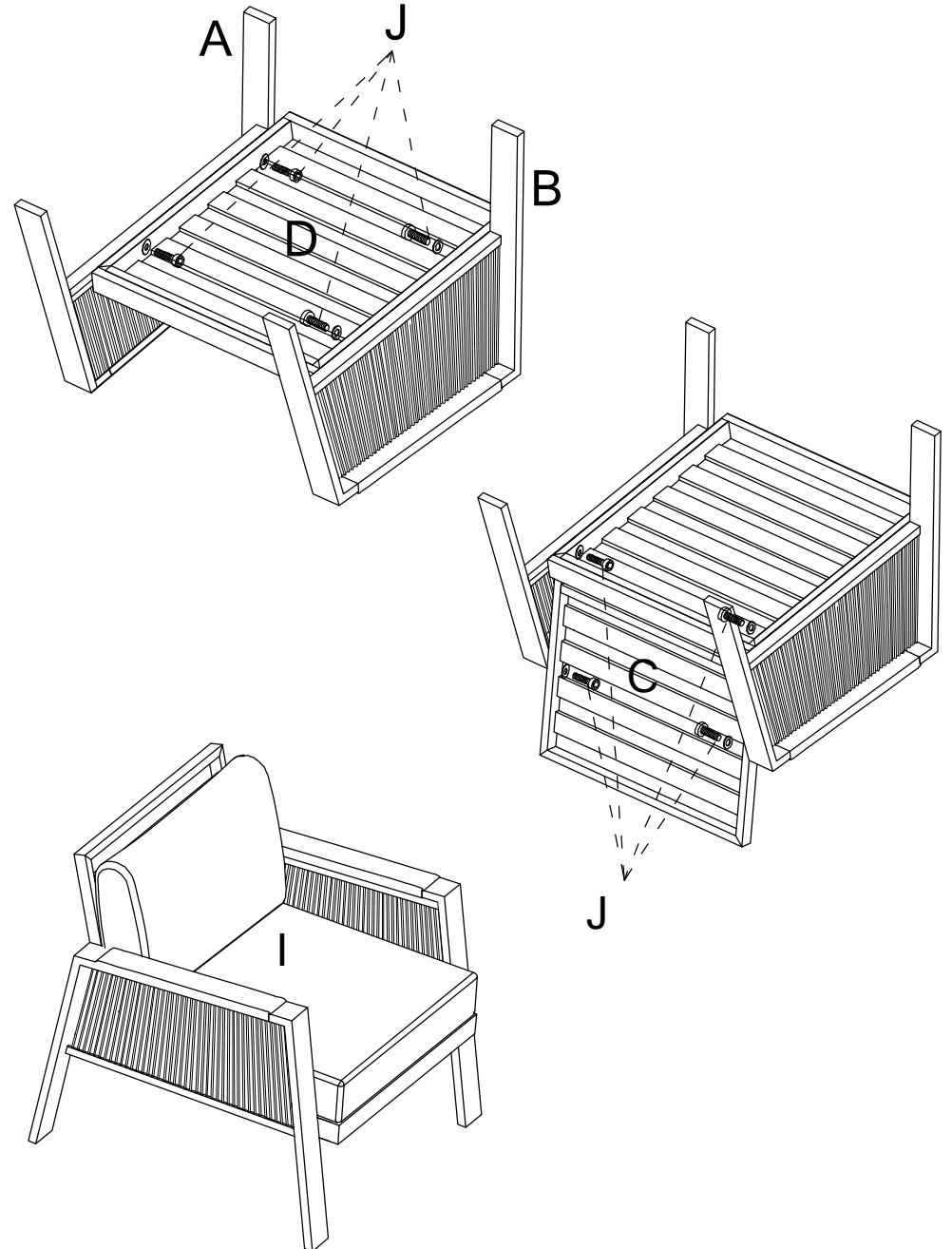

Do not fully tighten bolts until assembly is complete.

2. Assemble the sofa arms (A) and (B) to the seat (F) and the backrest (E), using bolts and washer (J).

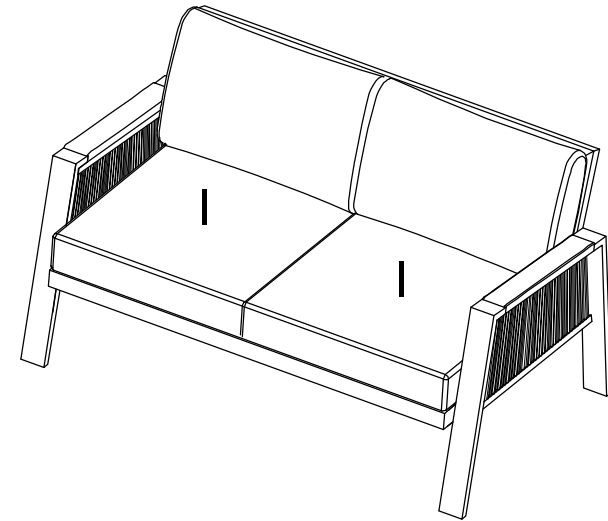
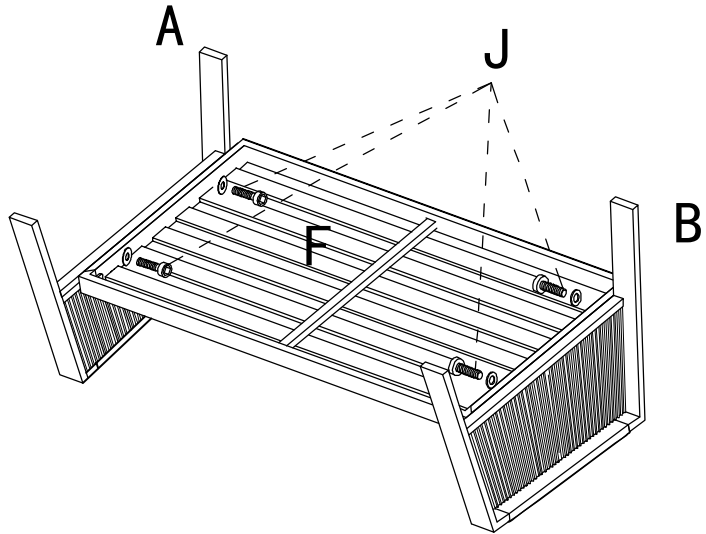

3. Assemble the table leg (H) to the table top (G), using bolts and washer (k).

